

20-6061

Weatherly No. 470



HEAVY DUTY

QUICK REFERENCE CATALOG



WE KEEP YOU MOVING!



Moving Vans,
Low Profile



Refuse



School Buses



Dumps/Tandem
Dumps/Tri-Axle Dumps



Transit/Coaches



Logging Trailers



Agricultural
Vehicles

FOR ADDITIONAL PRODUCT INFORMATION

Please Visit Our E-Catalog Rack At:
www.napaecatalog.com/market.php

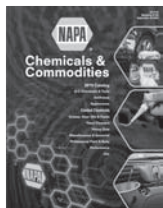

#20-2176
2019 NAPA Chemicals &
Commodities



#20-3619
2018 Tools & Equipment



Weatherly #560
NAPA Lighting

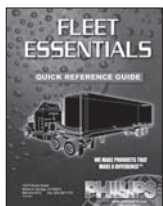

#B-FE-0509
Phillips Fleet Essentials
Quick Reference

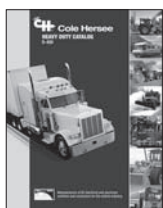

#D-400
Cole Hersee Heavy Duty
Catalog



#HDBRP-0907
Air Brake Parts Quick
Reference



#BW1114
Bendix Quick Reference



#HDSB-0907
HD Truck Spring Brake Quick
Reference



#HDUBS-0404
HD Truck Unlined Brake
Shoes



#HDSAC-0505
HD Suspension Air Control
Quick Reference



Weatherly #078
HD Clutch System Catalog

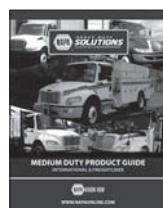

#NAPAMEDUTY16
NAPA HD Solutions
Medium Duty Product Guide



Weatherly #470
NAPA Heavy Duty Solutions



#20-6040
HD Truck Accessories Quick
Reference

TABLE OF CONTENTS

A. BRAKE FOUNDATION PARTS	3-68
B. WHEELS & WHEEL END COMPONENTS	69-86
C. AIR BRAKE PARTS	87-130
D. SUSPENSION	131-182
E. EXHAUST	183-190
F. FILTRATION	191-200
G. DRIVE SYSTEMS	201-212
H. TRUCK & TRAILER ACCESSORIES	213-234
I. LIGHTS & ELECTRICAL ACCESSORIES	235-294
J. UNDER THE HOOD	295-318
K. CHEMICAL PRODUCTS	319-327
L. INDEX	328-336





A

BRAKE FOUNDATION PARTS

HYDRAULIC BRAKE PAD IDENTIFICATION	4
HYDRAULIC DISC BRAKE PADS	5
HYDRAULIC DISC BRAKE ROTORS	6
HYDRAULIC DISC BRAKE CALIPERS	7
AIR DISC BRAKE PADS	8
AIR DISC BRAKE ROTORS	9
AIR DISC BRAKE CALIPERS	10
MANUAL SLACK ADJUSTERS	11
AUTOMATIC SLACK ADJUSTERS	12-24
CAMSHAFTS	25-34
CAMSHAFT REPAIR KITS	35-43
CAMSHAFT KIT COMPONENTS & AXLE PARTS	44
CAMSHAFT TUBE ENCLOSURES	45
TUBE ENCLOSURE PARTS	46
BRAKE SHOES	47-52
DRUMS, HUBS & ROTORS	53-61
AIR DISC BRAKE SYSTEMS	62-67



HEAVY DUTY HYDRAULIC BRAKE PAD IDENTIFICATION



Mold



Hook



Tab



Small House



Large House



Wing



Overall Length

Requires 4 Simple Steps:

1. Identify the style of the pads. (A)
2. Measure pad overall length. (B)
3. Measure pad overall height. (C)
4. Check identifiers. (D)

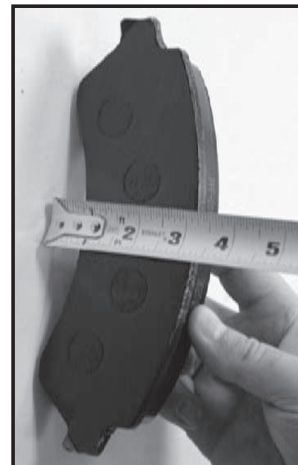

Overall Height

NOTE:

When measuring length and width:

INCLUDE the shim.

DO NOT INCLUDE squealer tab.

A	B	C	D	
Style Pads	Pad Overall Length	Pad Overall Height	Identifiers	GoldForce Caliper Part #
Hook Style Tab Style	269.5mm (10.61") Hook Pad 205.0mm (8.07") Tab Pad	100.0mm (3.93") 80.0mm (3.15")		TWD GFC55250
Large House Style	240.0mm (9.45")	88.6mm (3.49")	Replaces D1032 and DGFC1418	TWD GFC13706-7 TWD GFC14684012-3
Mold Style Tab Style	254.0mm (10.03") Mold Pad 205.0mm (8.07") Tab Pad	97.5mm (3.83") 80.0mm (3.15")		TWD GFC55314
Small House Style	213.4mm (8.40")	101.5mm (3.96")		TWD GFC55251
Small House Style	228.6mm (9.00")	102.6mm (4.04")		TWD GFC55252
Wing Style	222.0mm (8.74")	64.5mm (2.54")		TWD GFC147076 TWD GFC147077
Wing Style	244.1mm (9.61")	85.1mm (3.35")	Fits 73.0mm caliper plate/ friction 26.8mm (1.05")	TWD GFC55850
Wing Style	244.1mm (9.61")	85.1mm (3.35")	Fits 66.0mm caliper plate/ friction 20.3mm (0.80")	TWD GFC55849

⚠ WARNING: California Proposition 65 - Cancer and Reproductive Harm - www.P65Warnings.ca.gov.



PREMIUM HYDRAULIC DISC BRAKE PADS

GoldForce Hydraulic Pad #	Overall Length	Overall Width	Friction Thickness (Includes Plate)	Replaces Disc Pad Set Cross Reference #'s		
				Bendix/Form. Blue	Meritor	Performance Friction
TWD GFP1066-CE	222.0mm (8.74")	64.50mm (2.54")	20.3mm (.80")	E11110660	MD1066	1066.10
TWD GFP184-CE	254.0mm (10.03") 205.0mm (8.07")	97.5mm (3.83") 80.0mm (3.15")	16.0mm (.63") 21.8mm (.85")	E10901840	MD184 MD380 MMD380	0184.10
TWD GFP224-CE	213.4mm (8.40")	101.5mm (3.96")	18.5mm (.73")	E11102240	MD224 MMD224	0224.10
TWD GFP225-CE	269.5mm (10.61") 205.0mm (8.07")	100mm (3.93") 80.0mm (3.15")	22.3mm (.87") 26.5mm (1.04")	E11102250	MD225 MMD225	0225.10
TWD GFP236-CE	228.6mm (9.00")	102.6mm (4.04")	25.1mm (.98")	E11102360	MD236 MMD236	0236.20
TWD GFP769-CE (Replaces D1032, D1418)	240.0mm (9.45")	88.64mm (3.49")	25.2mm (1.00")	E1107690	MD769 MMD769 MVD769 KIT769AM KITD769GM	0769.10
TWD GFP786-CETK	244.1mm (9.61")	85.09mm (3.35")	26.8mm (1.05")	E10997861 E121107861	MD786 MMD786 MD786M MVD786	0786.11 0786.13 0786.23
TWD GFP786A-CETN	244.1mm (9.61")	85.09mm (3.35")	20.3mm (.80")	E11107860	MD786A MMD786A MD786AM MVD786A	0786.10 0786.12 0786.20

⚠ WARNING: California Proposition 65 - Cancer and Reproductive Harm - www.P65Warnings.ca.gov.

HYDRAULIC DISC BRAKE ROTORS

A

BRAKE FOUNDATION PARTS



PREMIUM HYDRAULIC DISC BRAKE ROTORS

GoldForce Hydraulic Rotor #	Application	Size	Specs	Replaces Disc Pad Set Cross Reference #'s					
				Bendix	Gunite	Meritor	OEM #	Performance Friction	Webb
TWD GFR141394G	Dodge/ Ford/ Sterling Rear/Ford LCF/IHC Front/Rear	15.35 X 4.88	10 Hole 0.50	E12570120			2608016C1		
TWD GFR19996G	Ford Front/ Rear, IHC Front/Rear	15.35 X 1.91	10 Hole 0.53	E12588025		R4483020	2599937C91	390.048.20	
TWD GFR54102G	GM Front	14.75 X 3.81	5 Hole 0.66	141271 E12585013	D6054	122687	15515768 15619954	N/A	54102P
TWD GFR54104G	GM/ Chevrolet Front	14.75 X 3.81	6 Hole 0.66	141585 E12685009	D6054A	122688		N/A	54104P
TWD GFR54105G	Ford Front ABS	14.75 X 3.81	6 hole 0.78	E12584020		123480		N/A	54105P
TWD GFR54301G	GM Front/ Rear	15.39 X 3.40	10 Hole 0.59	141272 E12585006	D6052	122729	155144016 156199700	N/A	54301P
TWD GFR54365G	Thomas Bus/Bluebird Bus/Ford	15.39 X 7.60	10 hole 0.94 U-Rotor C/W ABS	N/A	N/A	123574		390.193.20	54365P-65
TWD GFR54769G	Navistar Front ABS Application	15.00 X 3.50	5 Hole 0.78	141476 E12588021		123573	2594594C1	381.089.20	54769P-65
TWD GFR54770G	IHC Front/ Rear ABS Application	15.00 X 3.50	6 hole 0.78	141475 E12588020	D6194AM	123572	164677C1 2505097C1	381.089.30	54770P-65
TWD GFR54771G	Ford/ Freightliner/ Navistar/ Kenworth/ Peterbilt/ Sterling/ Blue Bird	15.00 X 4.44	10 Hole 0.59	141494 E12588018	D6183M	123552	2594596C1	381.113.20	54771P-65
TWD GFR54773G	Ford/ Freightliner/ Navistar/ Kenworth/ Peterbilt/ Sterling/ Blue Bird	15.00 X 3.20	10 Hole 0.58	E12588019	D6176M	123550	2594596C1	381.081.20	54773P-65
TWD GFR54775G	GM Front/ Rear Bluebird Front/ Thomas Front/Rear	15.38 X 3.40	10 Hole 0.58	E12585019		123557		390.086.20	54775P-65
TWD GFR6178AMG	Thomas Bus/ Bluebird Bus, Freightliner/ Peterbilt/ Kenworth	15.00 X 7.11	10 hole 1.06 U-Rotor C/W ABS	N/A	D6178AM	N/A		381.181.20	N/A

⚠ WARNING: California Proposition 65 - Cancer and Reproductive Harm - www.P65Warnings.ca.gov.



PREMIUM HYDRAULIC DISC BRAKE CALIPERS

GoldForce Hydraulic Caliper #	Description	Application	Yrs Used	Replaces Caliper Cross Reference #'s		Disc Pad Application	
				Bendix	Euclid	Performance Friction	GoldForce Hydraulic Pad #
TWD GFC13706-7	70mm Meritor R/L 3-hole	IHC/Ford	2009-2017	E14688014 E14688015	E-13706 E-13707	0769.10	GFP769-CE
TWD GFC14684012-3	70mm Meritor R/L 2-Hole	GM/Freightliner/ Sterling/Thomas	2000-2013	E14684012/3/8/9 E14685010/1/20/21	E-11733-SL E-11734-SL	0769.10	GFP769-CE
TWD GFC147076	60mm TRW Right	IHC/Ford	2005-2016	E14670076	E-12253	1066.10	GFP1066-CE
TWD GFC147077	60mm TRW Left	IHC/Ford	2005-2016	E14670077	E-12254	1066.10	GFP1066-CE
TWD GFC55250	2.88" Bendix	IHC/Freightliner/ Thomas	1979-2008	R55250 E14685008	E-4238X	0225.10	GFP225-CE
TWD GFC55251	2.5" Dayton Walther	GM/Ford/ Meritor	1979-2008	R55251 E14684106	E-11117X	0224.10	GFP224-CE
TWD GFC55252	2.88" Dayton Walther	Ford	1983-1999	R55252 E14684006	E-4245X	0236.20	GFP236-CE
TWD GFC55314	2.60" Bendix	IHC/Freightliner/ Thomas	1990-2004	R55314 E14675007	E-4237X	0184.10	GFP184-CE
TWD GFC55849	66mm Bosch	IHC/Freightliner/ Sterling/Thomas	1985-2016	R55849 E14688008	E-11750X	0786.10 0786.12 0786.20	GFP786A-CETN
TWD GFC55850	73mm Bosch	IHC/Freightliner/ Sterling/Thomas	1998-2016	R55850 E14688010	E-11756X	0786.11 0786.13 0786.23	GFP786-CETK

⚠ WARNING: California Proposition 65 - Cancer and Reproductive Harm - www.PG5Warnings.ca.gov.

AIR DISC BRAKE PADS

A

BRAKE FOUNDATION PARTS



PREMIUM AIR DISC BRAKE PADS

GoldForce Air Disc Pad # (SD: Severe Duty)	Used with Caliper App.	Replaces Disc Pad Set Cross Reference #'s			Matching GoldForce Air Disc Rotor #	Matching GoldForce Air Disc Caliper #
		Bendix #	Meritor #	OEM #		
TWD GFP1203-KV	Bendix SB7 or SN7	5013257 K109249 K109319 K046771K50	MMD1203AF	N8893599 611049		
TWD GFP1203-SD	Bendix SB7 or SN7 Severe Duty	K109318 K006060				
TWD GFP1310-KV	Meritor Elsa-2		68324558 68325344 68325346 68325901	N508206051, N508206052, 20976509, 21309468, 85107768		
TWD GFP1311-KV	Meritor EX225		MMD1311AF	04-01-1113	GFR56641G GFR56642G GFR76606G	
TWD GFP1311-SD	Meritor EX225 Severe Duty		KIT2252HBA KIT2252H2CE KIT2252H2DA KIT2252H2DA-2		GFR56641G GFR56642G GFR76606G	
TWD GFP1312-KV	Meritor D-Lisa		MDP5019 MDP5025 MDP5042 MDP5061	04-01-1007, 04-01-1019, 20825594, 3093919, 3093939, 85105485, 85506111		
TWD GFP1369-KV	Bendix ADB22X	802078 K070796	MMD1369AF		GFR76617G GFR76618G GFR76692G	GFADC109961X, GFADC109962X, GFADC109957X, GFADC109958X, GFADC113887X, GFADC113888X, GFADCO12341X, GFADCO12342X
TWD GFP1369-SD	Bendix ADB22X Severe Duty	K109113			GFR76617G GFR76618G GFR76692G	GFADC109961X, GFADC109962X, GFADC109957X, GFADC109958X, GFADC113887X, GFADC113888X, GFADCO12341X, GFADCO12342X
TWD GFP1407-KV	Meritor D-Elsa 1		MDP5017, MDP5038, MDP5041, MDP5054, MDP5065, MDP5090, MDP5091, MDP5110, MDP5031	N508206035 N508206044		
TWD GFP1438-KV TWD GFP1438-SD	Wabco PAN19		MMD1438AF	12999737	GFR71601G	GFADCW95037 GFADCW95038
TWD GFP1518-KV TWD GFP1518-SD	Wabco PAN17		MMD1518AF	12999808	GFR75180G	GFADCW75072 GFADCW75073
TWD GFP1777-KV TWD GFP1777-SD	Wabco PAN22		MMDWP22AF	12999796	GFR76613G	GFADCW25015 GFADCW25016 GFADCW50800 GFADCW50810
TWD GFP2061-KV	MAXXUS (Freightliner)	N/A	N/A	640 322 934 2	GFR20109G	

⚠ WARNING: California Proposition 65 - Cancer and Reproductive Harm - www.P65Warnings.ca.gov.



PREMIUM AIR DISC BRAKE ROTORS

GoldForce Air Disc Rotor #	Used with Caliper App.	Replaces Rotor Cross Reference #'s			Wabco#	Matching GoldForce Air Disc Pad #
		Bendix #	Meritor #	OEM #		
TWD GFR20109G	Wabco Maxxus			10020109 10020682		GFP2061-KV
TWD GFR56641G	Meritor EX225		68326014	15-02-1067 15-02-1043		GFP1311-KV GFP1311-SD
TWD GFR56642G	Meritor EX225		23-123642-002	15-03-1012		GFP1311-KV GFP1311-SD
TWD GFR71601G	Wabco PAN19		M44D71601		CT832	GFP1438-KV
TWD GFR75180G	Wabco PAN17		M44AD75180		CT826	GFP1518-KV
TWD GFR76606G	Meritor EX225		23-123647-002			GFP1311-KV GFP1311-SD
TWD GFR76613G	Wabco PAN22		M44D76613		CT807	GFP1777-KV
TWD GFR76617G	Bendix ADB22X	802082 K038574	M44D76617			GFP1369-KV GFP1369-SD
TWD GFR76618G	Bendix ADB22X	802081 K038573	M44D76618			GFP1369-KV GFP1369-SD
TWD GFR76692G	Bendix ADB22X	802569	M44D76692			GFP1369-KV GFP1369-SD

⚠ WARNING: California Proposition 65 - Cancer and Reproductive Harm - www.P65Warnings.ca.gov.

AIR DISC BRAKE CALIPERS

A

BRAKE FOUNDATION PARTS



PREMIUM AIR DISC BRAKE CALIPERS

GoldForce Air Disc Caliper #	Vehicle Application	Replaces Caliper Cross Reference #'s		Matching GoldForce Air Disc Pad #
		Bendix #	OEM #	
TWD GFADC012341X	SAF Axle (LH)	K012341X 0308006001Z	S-29152-16	GFP1369-KV GFP1369-SD
TWD GFADC012342X	SAF Axle (RH)	K012342X 03080005901Z	S-29152-17	GFP1369-KV GFP1369-SD
TWD GFADC109957X	Freightliner (RH)	K109957X K081256	K109957X K081256 K021299	GFP1369-KV GFP1369-SD
TWD GFADC109958X	Freightliner (LH)	K109958X K081257	K109958X K081257 K021300	GFP1369-KV GFP1369-SD
TWD GFADC109961X	Navistar/Kenworth/ Peterbilt/Volvo/Mack (RH)	K109961X K081142	K109961X K081142 802090	GFP1369-KV GFP1369-SD
TWD GFADC109962X	Navistar/Kenworth/ Peterbilt/Volvo/Mack (LH)	K109962X K081143	K109962X K081143 802091	GFP1369-KV GFP1369-SD
TWD GFADC113887X	Hendrickson Trailer (RH)	K113887X 802984 S-29152-14	K113887X 802984 S-29152-14	GFP1369-KV GFP1369-SD
TWD GFADC113888X	Hendrickson Trailer (LH)	K113888X 802985 S-29152-15	K113887X 802985 S-29152-15	GFP1369-KV GFP1369-SD
TWD GFADCW75072	PAN 17 Wabco (LH)	40175072 40175090 640175072R	S-36837-7 S-39094-L	GFP1518-KV GFP1518-SD
TWD GFADCW75073	PAN 17 Wabco (RH)	40175073 40175091 640175073R	S-36837-8 S-39094-R	GFP1518-KV GFP1518-SD
TWD GFADCW95037	PAN 19 Wabco (LH)	40195037 40195027 640195037R	S-36838-7 S-39093-L	GFP1438-KV GFP1438-SD
TWD GFADCW95038	PAN 19 Wabco (RH)	40195038 40195028 640195038R	S-36838-8 S-39093-R	GFP1438-KV GFP1438-SD
TWD GFADCW25015	PAN 22 Ridewell/AXN/ Reyco/Granning/IMT (LH)	40225015 40225011 640225015R	3080005100	GFP1777-KV GFP1777-SD
TWD GFADCW25016	PAN 22 Ridewell/AXN/ Reyco/Granning/IMT (RH)	40225016 40225012 640225016R	3080005000	GFP1777-KV GFP1777-SD
TWD GFADCW50800	PAN 22 Hendrickson/ Meritor (LH)	6402250800 6402250360	S-33648-2 S-32676-7	GFP1777-KV GFP1777-SD
TWD GFADCW50810	PAN 22 Hendrickson/ Meritor (RH)	6402250810 64002250370	S-33648-3 S-32676-8	GFP1777-KV GFP1777-SD

⚠ WARNING: California Proposition 65 - Cancer and Reproductive Harm - www.P65Warnings.ca.gov.



MANUAL SLACK ADJUSTERS

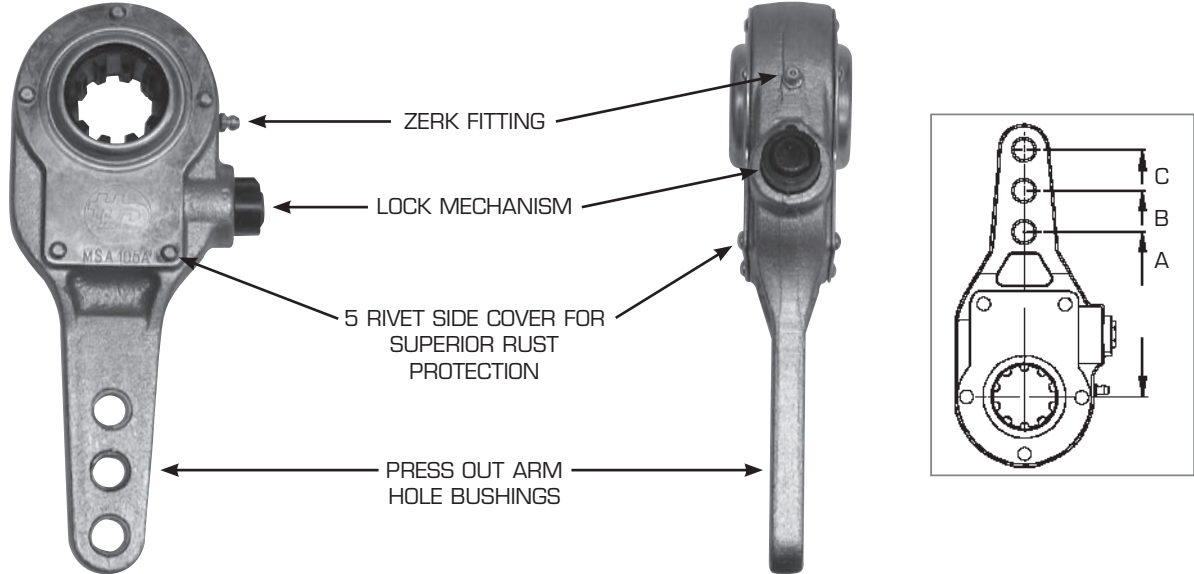

ARM BUSHING

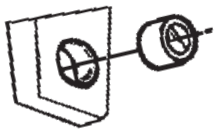
	PART NO.	ARM LENGTH O.D.	ARM LENGTH I.D.
	TWD MSA500	5/8"	1/2"

STRAIGHT ARM - 10 SPLINE

PART NO.	ARM LENGTH			DIAMETER SPLINE	APPLICATIONS
	A	B	C		
TWD MSA105A	5"	6"	7"	1-1/2" - 10	POPULAR TRAILER AXLE
TWD MSA106A	5-1/2"	6-1/2"	-	1-1/2" - 10	POPULAR DRIVE AXLE

STRAIGHT ARM - 28 SPLINE

PART NO.	ARM LENGTH			DIAMETER SPLINE	APPLICATIONS
	A	B	C		
TWD MSA111A	5-1/2"	6-1/2"	-	1-1/2" - 28	POPULAR DRIVE AXLE
TWD MSA112A	5"	6"	7"	1-1/2" - 28	POPULAR TRAILER AXLE

STRAIGHT ARM - 37 SPLINE

PART NO.	ARM LENGTH			DIAMETER SPLINE	APPLICATIONS
	A	B	C		
TWD MSA113A	6"	-	-	1-37/64" - 37	FRUEHAUF AXLE

⚠ WARNING: California Proposition 65 - Cancer and Reproductive Harm - www.P65Warnings.ca.gov.



SLACK ADJUSTERS

ABA - AUTOMATIC SLACK ADJUSTERS



FIG. 1
TWD D0010140

FIG. 2
TWD D0010144

FIG. 3
TWD D0010211

FIG. 4
TWD D0010306

PART NO.	SPLINE	ARM LENGTH	INSTALLATION KIT (INCLUDED)	APPLICATION	FIG.
TWD D0010140	1-1/2 - 28	5" OR 6"	F42710553	STANDARD	1
TWD D0010143	1-1/2 - 10	5-1/2" OR 6-1/2"	F42710553	STANDARD	1
TWD D0010144	1-1/2 - 28	6"	F42710566	MACK TRUCK	2
TWD D0010211	1-1/2 - 28	5-1/2"	F42710563	TRAILER, 16-1/2" BRAKE ASSY.	3
TWD D0010212	1-1/2 - 28	6"	F42710563	TRAILER, 16-1/2" BRAKE ASSY.	3
TWD D0010215	1-1/2 - 10	5-1/2"	F42710563	TRAILER, 16-1/2" BRAKE ASSY.	3
TWD D0010216	1-1/2 - 10	6"	F42710563	TRAILER, 16-1/2" BRAKE ASSY.	3
TWD D0010306	1-1/2 - 10	6"	F42710563	TRAILER, 12-1/4" BRAKE ASSY.	4

AUTOMATIC SLACK ADJUSTERS

PART NO.	BRAND	CROSS REF. #	AUTO/MANUAL	DESCRIPTION
TWD HAS1132	FLEETSPEC	GUNITE AS1132	AUTO SLACK	ASA, GUNITE STYLE
TWD HAS1133	FLEETSPEC	GUNITE AS1133	AUTO SLACK	ASA, GUNITE STYLE
TWD HAS1136	FLEETSPEC	GUNITE AS1136	AUTO SLACK	ASA, GUNITE STYLE
TWD HAS1140	FLEETSPEC	GUNITE AS1140	AUTO SLACK	ASA, GUNITE STYLE
TWD HAS1141	FLEETSPEC	GUNITE AS1141	AUTO SLACK	ASA, GUNITE STYLE
TWD HAS1147	FLEETSPEC	GUNITE AS1147	AUTO SLACK	ASA, GUNITE STYLE
TWD H801041	FLEETSPEC	MERITOR R801041	AUTO SLACK	ASA, MERITOR STYLE
TWD H801042	FLEETSPEC	MERITOR R801042	AUTO SLACK	ASA, MERITOR STYLE
TWD H801073	FLEETSPEC	MERITOR R801073	AUTO SLACK	ASA, MERITOR STYLE
TWD H801074	FLEETSPEC	MERITOR R801074	AUTO SLACK	ASA, MERITOR STYLE

⚠ WARNING: California Proposition 65 - Cancer and Reproductive Harm - www.P65Warnings.ca.gov.

SLACK ADJUSTERS (continued)			
COMPONENTS			
	PART NO.	DESCRIPTION	NOTE
	TWD HAS3000	THREADED STRAIGHT 5/8 - 18"	STANDARD PINS
	TWD HAS3016	COLLAR LOCK STRAIGHT 5/8 - 18"	STANDARD PINS
	TWD HAS3018	EXTENDED COLLAR LOCK STRAIGHT 5/8 - 18"	STANDARD PINS
	TWD HAS3019	COLLAR LOCK STRAIGHT 1/2 - 20" & 5/8 - 18"	STANDARD PINS
	TWD HAS4004	CLEVIS PIN KIT	(6) 1/2" CLEVIS PINS, (6) 1/4" CLEVIS PINS, (12) COTTER PINS

 WARNING: California Proposition 65 - Cancer and Reproductive Harm - www.P65Warnings.ca.gov.



SLACK ADJUSTERS (continued)

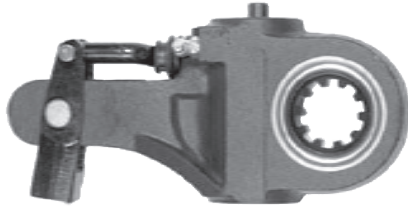

TWD HD21106S

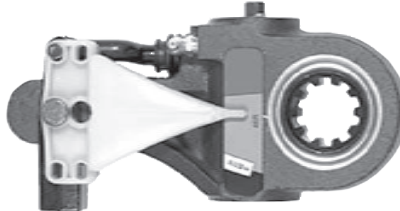

TWD HD41106SE

WITHOUT STROKE INDICATOR - 5/8" CLEVIS

PART NO.	SPLINE	ARM	NOTES
TWD HD21106S	1-1/2 - 10	6"	REPLACES: STEMCO MK21106S
TWD HD22100S	1-1/2 - 28	5-1/2"	REPLACES: STEMCO MK22100S
TWD HD22153S	1-1/2 - 28	5" OR 6"	12-1/4" S CAM REPLACES: STEMCO MK22153S

**FOR STANDARD STROKE, WITH STROKE INDICATOR
5/8" EXTENDED CLEVIS**

PART NO.	SPLINE	ARM	NOTES
TWD HD41106S	1-1/2 - 10	6"	REPLACES: STEMCO MK41106S, MK41706S

5/8" EXTENDED CLEVIS KIT

	PART NO.	DESCRIPTION
	TWD HD8480KTA	EXTENDED STRAIGHT CLEVIS WITH 1/2" AND 1/4" PINS

⚠ WARNING: California Proposition 65 - Cancer and Reproductive Harm - www.P65Warnings.ca.gov.



AUTOMATIC BRAKE ADJUSTERS

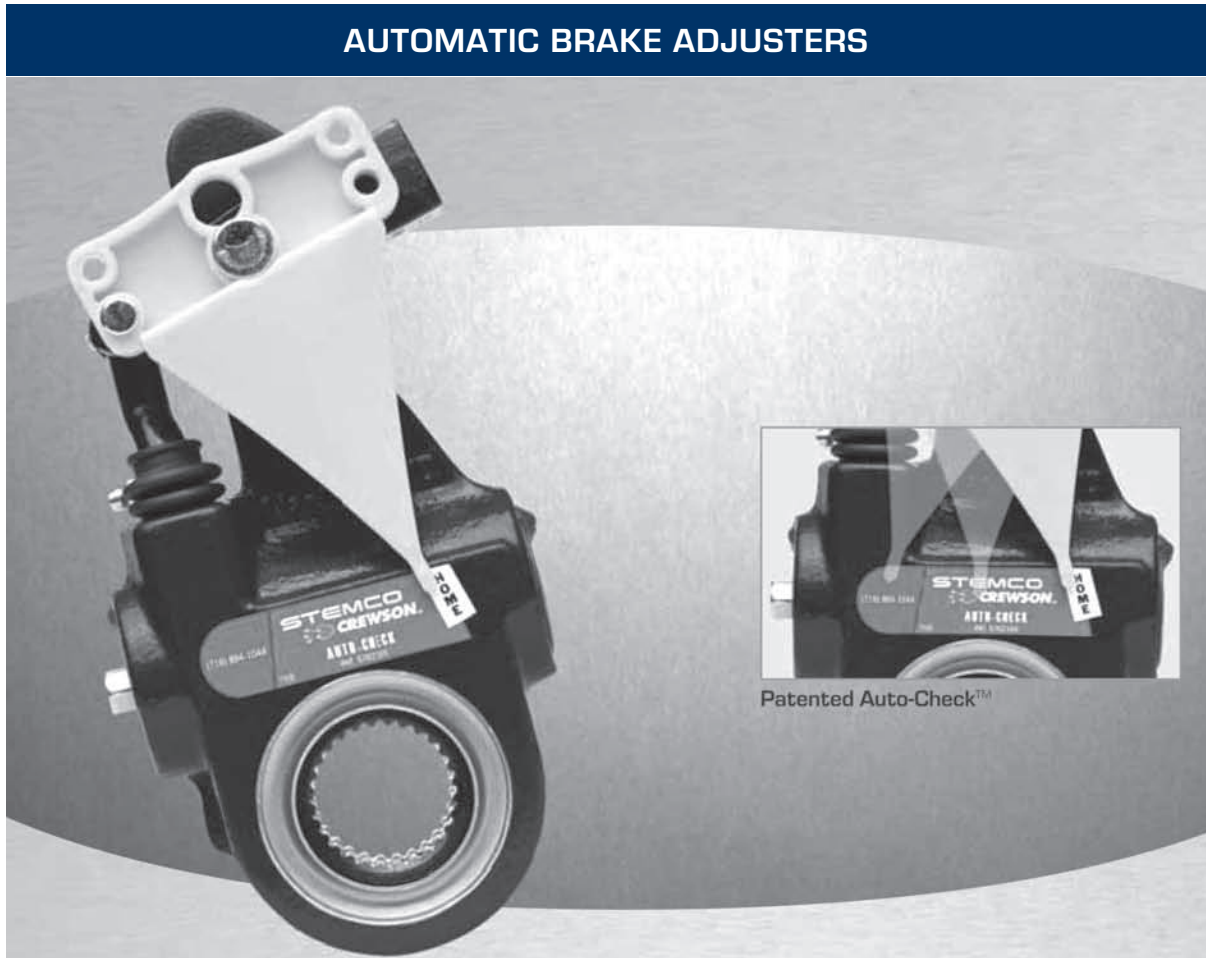

Patented Auto-Check™

Reduce time spent under your trucks and increase safety.

Stemco Crewson Brake Adjusters. Designed for maximum safety and convenience. With Stemco Crewson Brake Adjusters you'll have an easier time making sure your trucks are up to code and operating safely. Our brake adjusters have been designed with a variety of patented features including:

- Auto Check™: This patented feature allows you to check brake stroke without crawling under the truck.
- Cam Guard: This lubrication system eliminates seizing and corrosion.
- Patented Installation Template: This handy guide ensures the ABA is installed correctly every time.
- Patented Clearance Sensing Adjuster System: Stemco Crewson features the only patented reduced wear clutch in the industry.
- High Strength Gearset: Assures the ABA will stand up to years of service in demanding conditions.
- Blue Powder Coat: Protects the ABA from harsh winter conditions.
- Sealing: The gear is sealed with a proprietary system that protects it from environmental contamination.



AUTOMATIC BRAKE ADJUSTERS (continued)

The Stemco Crewson Automatic Brake Adjuster maintains proper shoe-to-drum clearance in all braking modes and is easily installed in the field or on the shop floor.

Installation

The Stemco Crewson Automatic Brake Adjuster comes with our patented, structurally rigid installation guide. This handy and fool-proof guide ensures that even first time users can install the ABA correctly every time.

Auto-Check™

Our patented Auto-Check™ feature is designed to provide a method of checking the brake stroke without going under the truck.

- Installed on the ABA facing the center of the vehicle to easily see if brake stroke is in a normal range.
- Bright yellow pointer and indicator easily corrects set-up position, determines working stroke and shows if brake stroke is past re-adjust limit without crawling under vehicle.
- Offers you an extra quality control check.

Long Life Adjustment System

Heavy-duty internal components with a clearance sensing clutch enables your brake system to adjust for hot braking conditions. This patented STEMCO Crewson design protects the adjusting components during normal brake applications when brake adjustment is not required. Over 90% of all brake applications do not require adjustment, so they subject the adjusting components to continuous wear.

The STEMCO Crewson Adjustment System operates like the windshield wipers on your car — it is utilized only when needed, not continuously when the car is running.

- A typical highway vehicle makes about two million brake applications in five years.
- This same vehicle will require the ABA to adjust the brake about 3,000 times.

Warranty

This warranty is not applicable to failures caused by improper installation, repair, alteration, accidents, abuse, improper use, normal wear and tear. The below is only a partial copy of the warranty. For a complete copy of the warranty, please contact your local Stemco Crewson distributor. Stemco Crewson reserves the right to modify our warranty policy without notice.



Installation Guide



Detail of Auto-Check™ Feature

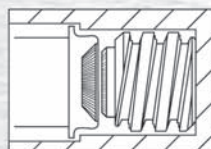

Figure A shows components disengaged to reduce wear (over 90% of the time).

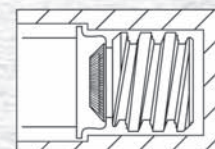

Figure B shows components engaged during brake adjustment (less than 10% of the time).

Warranty Period (Whichever occurs first)	6 years/ 1 million miles	2 years/ 200,000 miles	1 year/ 100,000 miles
ABAs used for	On-Highway Trucks Tractors, and Trailers	Off-Highway Applications (e.g. construction vehicles)	Severe Service ABAs (e.g. refuse pickup, school buses, or city deliveries)



STEMCO CREWSON PART NUMBERS

(MK) ALL AFTERMARKET PART NUMBERS

(A) AUTO CHECK STROKE INDICATOR

- (2) No "Auto-Check" Indicator
- (3) T-16, 20, 24 Std. Stroke Chamber
- (4) T-30 Std. Stroke Or T-16, 24 LS Chamber
- (5) T-36 Std. Stroke Chamber
- (7) T-24, 30 Long Stroke Chamber

(B) SPLINE (Diameter - Splines)

- (1) 1-1/2 - 10
- (2) 1-1/2 - 28
- (3) 1-5/8 - 37
- (4) 1-1/4 - 10
- (5) 1-1/4 - 24

(C) CLEVIS TYPE & SIZE

- (0) No Clevis
- (1) 5/8 - 18 Straight
- (2) 1/2 - 20 Straight
- (3) 5/8 - 18 Offset
- (4) 1/2 - 20 Offset
- (5) 16 X 1.5mm Straight
- (7) 5/8 - 18 Straight Extended
- (8) 5/8 - 18 Short Throat
- (9) 5/8 - 18 Short Throat 5/8 Offset
- (A) 3/4 - 16 Straight
- (E) 1/2 - 20 Straight Extended
- (G) 3/4 - 16 Straight Extended
- (L) 16 X 1.5mm Offset

(D) BRAKE SIZE/TYPE

- (0) Std S-Cam Brake
- (5) 12.25 S-Cam Brake Curved Arm

(E) ARM LENGTH

- (0) 5.5"
- (1) 6.5"
- (2) 5.5", 6.5"
- (3) 5", 6"
- (4) 5", 6", 7"
- (5) 5"
- (6) 6"
- (7) 5.5" Short Arm

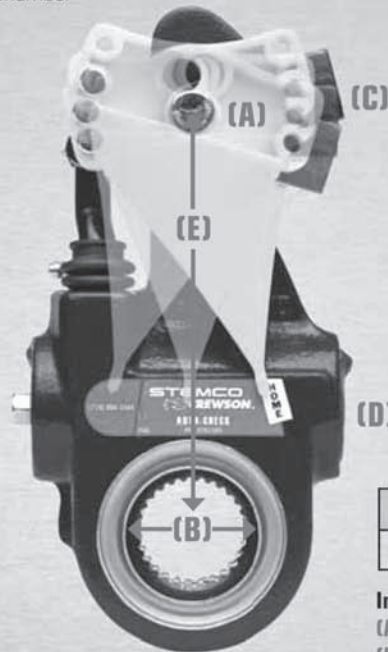

EXAMPLE

MK	(A)	(B)	(C)	(D)	(E)
MK	4	2	1	0	6

In This Example:

- (A) Would be a STD Type 30 Auto Check
- (B) Would be a 1-1/2"-28 Spline
- (C) Would be a 5/8-18 Straight Clevis
- (D) Would be a Standard S-Cam Brake
- (E) Would be a 6" Arm Length



CLEVIS KIT AND PINS

- Pin kit included
- New Type "Black"

	PART NO.	THREAD	DESCRIPTION
	TWD MC8410KTAS	1/2" - 20	STRAIGHT CLEVIS
	TWD MC8415KTAS	1/2" - 20	OFFSET CLEVIS
	TWD MC8420KTAS*	5/8" - 18	STRAIGHT CLEVIS
	TWD MC8425KTAS	5/8" - 18	OFFSET CLEVIS
	TWD MC8480KTAS	5/8" - 18	EXTENDED STRAIGHT CLEVIS

*Most Popular

⚠ WARNING: California Proposition 65 - Cancer and Reproductive Harm - www.P65Warnings.ca.gov.

	PART NO.	DESCRIPTION
	TWD MC8056KTAS	FOR BOTH TYPES

⚠ WARNING: California Proposition 65 - Cancer and Reproductive Harm - www.P65Warnings.ca.gov.



MERITOR

CLEVIS PINS

AUTOMATIC SLACK ADJUSTER CLEVIS PINS

	PART NO.	LENGTH	DIAMETER	REPLACES
	TWD R801730	1-37/64"	1/4"	19X127
	TWD R801732	1-3/4"	1/2"	19X45
	TWD R801773	1-7/8"	1/2"	19X1084, 19X60
	TWD R801774	2"	1/2"	19X1083

AY PAWL ASA

	PART NO.	DESCRIPTION
	TWD R801700	PULL PAWL ASSEMBLY WITH CURVED FACE. USE ON ALL MERITOR AUTOMATIC SLACK ADJUSTERS.

⚠ WARNING: California Proposition 65 - Cancer and Reproductive Harm - www.P65Warnings.ca.gov.



GUNITE SLACK ADJUSTERS - FEATURES AND BENEFITS

- Unhanded design
- Compact housing for easy installation
- Double sealed actuator arm
- Factory lubricated and sealed
- Extended life clevis pin bushing
- O-ring on spline gear
- New tru-seal link boot with 6 bellows instead of 4 bellows

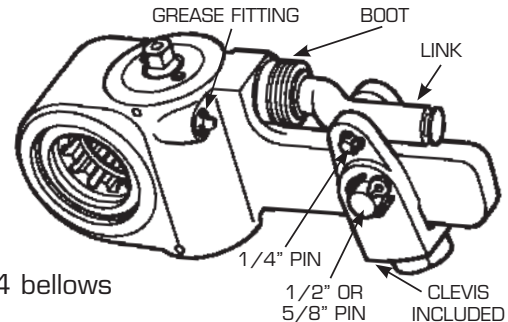

STRAIGHT ARM (LONG STROKE) - 10 SPLINE

PART NO.	ARM LENGTH	DIAMETER SPLINE	APPLICATIONS	CLEVIS
TWD AS1136	5-1/2"	1-1/4" - 10	STEER AXLE	AS3019
TWD AS1132	5-1/2"	1-1/2" - 10	STEER OR DRIVE AXLE	AS3019
TWD AS1133	6"	1-1/2" - 10	DRIVE AXLE	AS3016

STRAIGHT ARM (LONG STROKE) - 24 SPLINE

PART NO.	ARM LENGTH	DIAMETER SPLINE	APPLICATIONS	CLEVIS
TWD AS1138	5-1/2"	1-1/4" - 24	DRIVE AXLE	AS3019

STRAIGHT ARM (LONG STROKE) - 28 SPLINE

PART NO.	ARM LENGTH	DIAMETER SPLINE	APPLICATIONS	CLEVIS
TWD AS1140	5-1/2"	1-1/2" - 28	STEER OR DRIVE AXLE	AS3019
TWD AS1141	6"	1-1/2" - 28	DRIVE AXLE	AS3016
TWD AS1150*	6"	1-1/2" - 28	TRAILER AXLE	AS3018

SERVICE KIT

PART NO.	DESCRIPTION
TWD AS4004	CLEVIS PIN KIT (6 OF 1/2", 6 OF 1/4" PINS AND 12 COTTER PINS)

*Extended Clevis For Trailer Application Included

⚠ **WARNING:** California Proposition 65 - Cancer and Reproductive Harm - www.P65Warnings.ca.gov.



MERITOR

TYPE 1, 2 & 3 SLACK ADJUSTERS

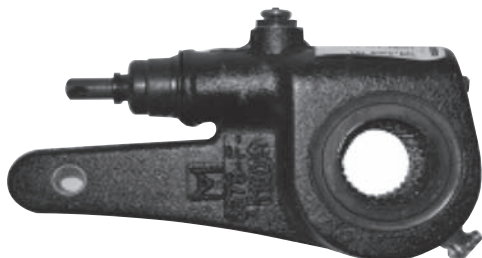

Important: The location of the pawl assembly is identified on the TYPE 1 and TYPE 2 slack adjusters. The installation of the slack adjuster must allow for the pawl to be removed during maintenance.

Meritor slack adjusters do not include a clevis pin.

STRAIGHT ARM - 10 SPLINE - TYPE 3 (ON HANDED)

PART NO.	ARM LENGTH	DIAMETER SPLINE	CLEVIS	APPLICATIONS
TWD R803195	5-1/2"	1-1/2" - 10	ROCR810019	STEER/DRIVE/TRAILER AXLE
TWD R803106	6"	1-1/2" - 10	ROCR810019	STEER/DRIVE/TRAILER AXLE

STRAIGHT ARM - 28 SPLINE - TYPE 3 (ON HANDED)

PART NO.	ARM LENGTH	DIAMETER SPLINE	CLEVIS	APPLICATIONS
TWD R803110	5-1/2"	1-1/2" - 28	ROCR810019	STEER/DRIVE/TRAILER AXLE
TWD R803112	6"	1-1/2" - 28	ROCR810019	DRIVE/TRAILER AXLE

STRAIGHT ARM - 28 SPLINE - TYPE 2 (RIGHT HAND)

PART NO.	ARM LENGTH	DIAMETER SPLINE	CLEVIS	APPLICATIONS
TWD R803049	5-1/2"	1-1/2" - 28	ROCR810019	STEER/DRIVE/TRAILER AXLE
TWD R803055	6"	1-1/2" - 28	ROCR810019	STEER/DRIVE/TRAILER AXLE

STRAIGHT ARM - 28 SPLINE - TYPE 1 (LEFT HAND)

PART NO.	ARM LENGTH	DIAMETER SPLINE	CLEVIS	APPLICATIONS
TWD R803048	5-1/2"	1-1/2" - 28	ROCR810019	STEER/DRIVE/TRAILER AXLE
TWD R803054	6"	1-1/2" - 28	ROCR810019	DRIVE/TRAILER AXLE

⚠ WARNING: California Proposition 65 - Cancer and Reproductive Harm - www.P65Warnings.ca.gov.

CLEVIS KITS TO STOCK

TYPE	PART NO.	CLEVIS TYPE	CHAMBER PUSH ROD THREAD	STOCK QTY PER 100 SLACKS SOLD
STANDARD STROKE CHAMBER	TWD R810019	STRAIGHT	5/8"-18	25
	TWD R810025	5/8" OFF SET	5/8"-18	5
LONG STROKE CHAMBER	TWD R810021	STRAIGHT	5/8"-18	80
FOR STANDARD TYPE 9, 12 AND 16 CHAMBERS	TWD R810018	STRAIGHT	1/2"-20	25

⚠ WARNING: California Proposition 65 - Cancer and Reproductive Harm - www.P65Warnings.ca.gov.



FEATURES AND BENEFITS

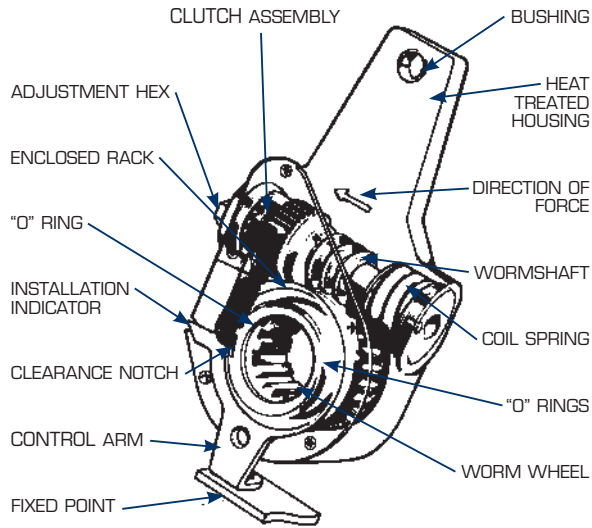

- Exclusive built-in "installation indicator" visually confirms correct installation.
- Haldex automatic brake adjusters cover more applications than any other brand.
- #1 Selling automatic brake adjuster with over 10,000 units sold.
- Backed by the industry's longest warranty - 6 years or 750,000 miles.
- Proven clearance sensing design.
- Heat treated housing to increase service life.

SELECTING AUTOMATIC SLACK ADJUSTERS

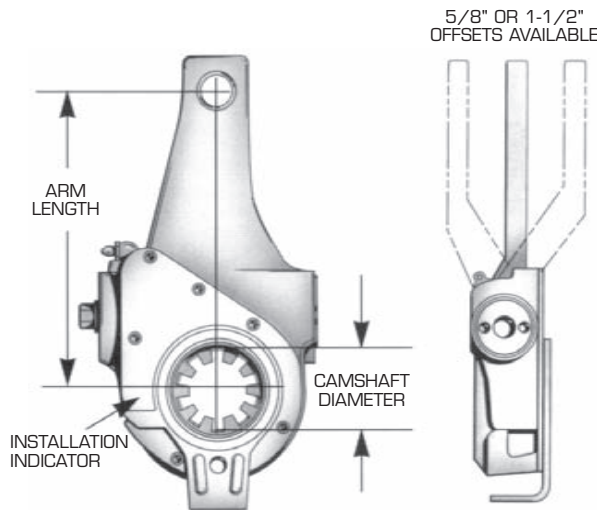

- STEP 1**
Determine what axle adjuster will be used on.
- STEP 2**
Determine the camshaft diameter and number of splines.
- STEP 3**
Determine the adjuster arm length.
- STEP 4**
Select the proper brake adjuster.



AUTOMATIC SLACK ADJUSTERS

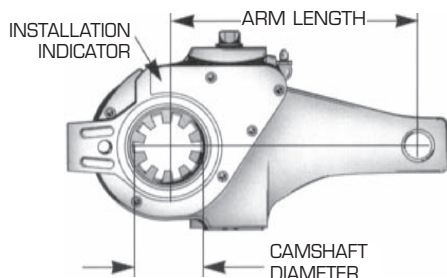

STRAIGHT ARM - 10 SPLINE

PART NO.	ARM LENGTH	DIAMETER SPLINE	APPLICATIONS	BRACKET KIT NO.
MBI 40010001	5-1/2"	1-1/4" - 10	STANDARD STEER AXLE	42710566
MBI 40010013	5-1/2"	1-1/4" - 10	NON-STANDARD STEER AXLE	42710401
MBI 40010121	5-1/2" - 6-1/2"	1-1/2" - 10	STANDARD DRIVE AXLE	42710553
MBI 40010142	5" - 6"	1-1/2" - 10	STANDARD DRIVE AXLE	42710553
MBI 40010143	5-1/2" - 6-1/2"	1-1/2" - 10	STANDARD DRIVE AXLE	42710553
MBI 40010155	5-1/2"	1-1/2" - 10	KENWORTH 8-BAG SUSPENSION	42710554
MBI 40010216	6"	1-1/2" - 10	TRAILER AXLE 16-1/2" BRAKE	42710563
MBI 40010215	5-1/2"	1-1/2" - 10	TRAILER AXLE 16-1/2" BRAKE	42710563
MBI 40010224	6"	1-1/2" - 10	TRAILER AXLE 16-1/2" BRAKE (1-1/2" OFFSET)	42710423
MBI 40010225	6"	1-1/2" - 10	TRAILER AXLE 16-1/2" BRAKE (1-1/2" OFFSET)	42710423

STRAIGHT ARM - 24 OR 28 SPLINE

PART NO.	ARM LENGTH	DIAMETER SPLINE	APPLICATIONS	BRACKET KIT NO.
MBI 40010008	5-1/2"	1-1/2" - 28	STANDARD STEER AXLE	42710566
MBI 40010070	5-1/2"	1-1/2" - 28	STANDARD STEER AXLE	42710576
MBI 40010140	5" - 6"	1-1/2" - 28	STANDARD DRIVE AXLE	42710553
MBI 40010141	5-1/2" - 6-1/2"	1-1/2" - 28	STANDARD DRIVE AXLE	42710553
MBI 40010144	6"	1-1/2" - 28	MACK DRIVE AXLE	42710566
MBI 40010156	5-1/2"	1-1/2" - 28	KENWORTH 8-BAG SUSPENSION	42710554
MBI 40010211	5-1/2"	1-1/2" - 28	TRAILER AXLE 16-1/2" BRAKE	42710563
MBI 40010212	6"	1-1/2" - 28	TRAILER AXLE 16-1/2" BRAKE	42710563

STRAIGHT ARM - 37 SPLINE

PART NO.	ARM LENGTH	DIAMETER SPLINE	APPLICATIONS	BRACKET KIT NO.
MBI 40010214	6"	1-5/8"	FRUEHAUF AXLE	42710563

CURVED ARM

PART NO.	ARM LENGTH	DIAMETER SPLINE	APPLICATIONS	BRACKET KIT NO.
MBI 40010305	6"	1-1/2" - 28	TRAILER AXLE 12-1/4" BRAKE	42710563
MBI 40010306	6"	1-1/2" - 10	TRAILER AXLE 12-1/4" BRAKE	42710553

⚠ WARNING: California Proposition 65 - Cancer and Reproductive Harm - www.P65Warnings.ca.gov.



SELF-SETTING AUTOMATIC BRAKE ADJUSTER

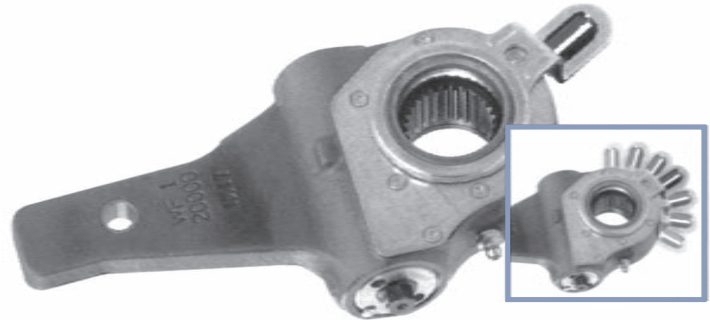

STRAIGHT ARM				
PART NO.	ARM LENGTH	DIAMETER SPLINE	APPLICATIONS	BRACKET KIT NO.
MBI 40020215	5-1/2"	1-1/2" - 10	TRAILER AXLE 16-1/2" BRAKE	42710563
MBI 40020216	6"	1-1/2" - 10	TRAILER AXLE 16-1/2" BRAKE	42710553
MBI 40020211	5-1/2"	1-1/2" - 28	TRAILER AXLE 16-1/2" BRAKE	42710553
MBI 40020212	6"	1-1/2" - 28	TRAILER AXLE 16-1/2" BRAKE	42710563
MBI 40020214	6"	1-1/2" - 37	FRUEHAUF AXLE	42710563





DOUBLE BEND FLAT STUD KIT		
	PART NO.	DESCRIPTION
	MBI 42710558	INCLUDES: • 4 X 45210125 - BUSHINGS • 4 X 44310318 - STUDS • 4 X 44310204 - NUTS

PLASTIC BUSHING (BLACK RECTANGULAR)		
	PART NO.	DESCRIPTION
	MBI 45210125	CONTROL ARM BUSHING (1-1/4" O.D. X 3/4" I.D.)

⚠ WARNING: California Proposition 65 - Cancer and Reproductive Harm - www.PG5Warnings.ca.gov.

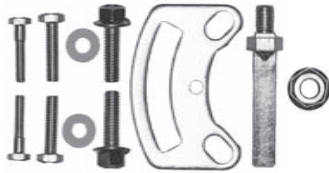
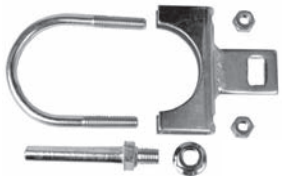

AUTOMATIC BRAKE ADJUSTER COMPONENTS

ABA BRACKET KIT		
	PART NO.	DESCRIPTION
	MBI 42710553	ANGLED STRAP 1-1/4" X 7"
	MBI 42710563	PLATE & HARDWARE FOR 12-1/4 BRAKES
	MBI 42710563	PLATE & HARDWARE FOR 12-1/4 BRAKES
ABA HARDWARE		
	PART NO.	DESCRIPTION
	MBI 44310204	7/16-14 FLANGE NUT FOR FLAT STUD
	MBI 44310318	7/16-14 FLANGE NUT FOR FLAT STUD
	MBI 45210058	CLEVIS BUSHING 1/2" I.D. X 5/8" O.D.
	MBI 45210058	SERRATED CLEVIS BUSHING 1/2" I.D. X 3/4" O.D.
	MBI 45210128	SERRATED CLEVIS BUSHING 5/8" I.D. X 13/16" O.D.
	MBI 45210129	SERRATED CLEVIS BUSHING 1/2" I.D. X 5/8" O.D.

⚠ WARNING: California Proposition 65 - Cancer and Reproductive Harm - www.P65Warnings.ca.gov.

CAMSHAFTS

When you buy a camshaft, you're buying experience from a highly qualified production team. The production processes mentioned below meet the strictest standards set in OEM brake camshafts. Camshafts continuously abide by these processes, in order to provide OEM quality brake camshafts.

GENERAL INFORMATION

Each end is induction hardened for maximum strength, durability and reliability

All camshaft splines are inspected with a "go no go" gauge for proper spline pitch as specified by OEM.

High-grade alloy steel and precision machining maintain critical geometry of s-head. Each head is centered 100% for maximum brake performance.

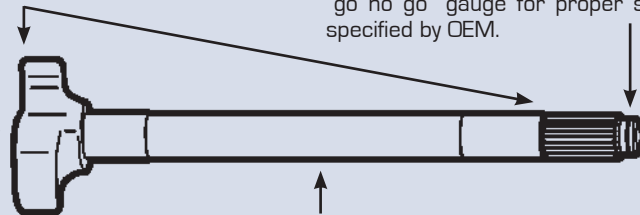

Full-sized shaft body assures correct journal diameter and head/shaft concentricity. 100% inspected using the tightest OEM specs, in order to obtain the correct body sizes.

CAMSHAFT HEAD DESIGNS

STANDARD "S"

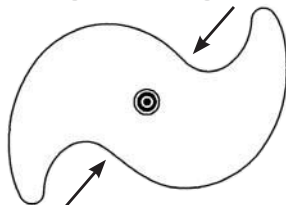

1-3/8"

HIGH RISE "S"

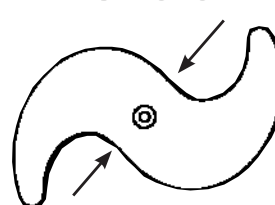

1-1/8"

SML "S"

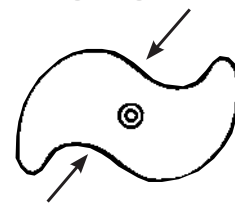

1-1/16"

Notes: When replacing Standard "S" with "High Rise" or "High Rise" with Standard "S", we recommend they be replaced in pairs.

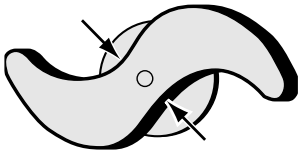
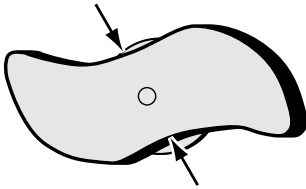
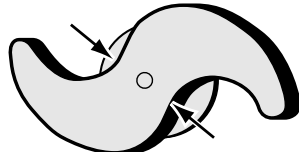
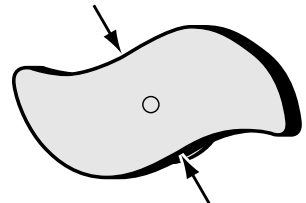
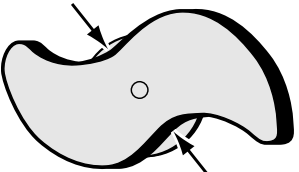
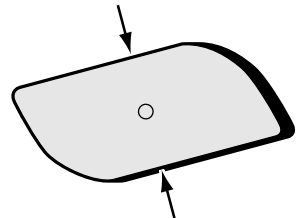
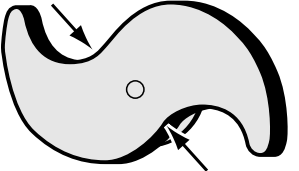
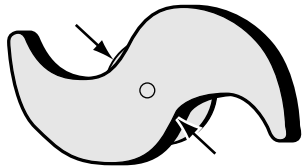
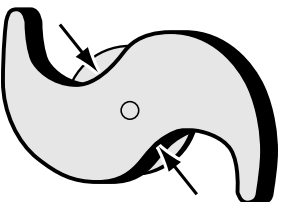
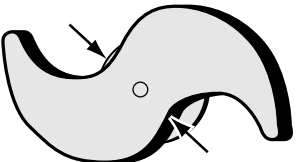

HEAD-SIZE			
	DESCRIPTION		DESCRIPTION
	11/16"		1-3/16"
	13/16"		1-1/4"
	1"		1-5/16"
	1-1/16"		1-3/8"
	1-1/8"		1-3/4"

DEXTER TRAILER AXLE 12-1/4" BRAKES

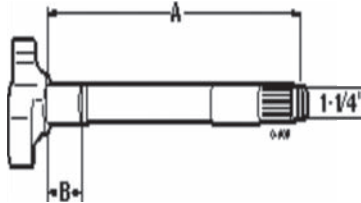

1-1/2" Dia. - 28 Spline
"A" Dimension: under head to beginning of lock ring groove

PART NO.	A	B	GENERAL INFORMATION
TWD CAM343L	22-5/16"	2-7/32"	USE CAM KIT(S): HCK1412, HCK1412Z
TWD CAM343R			

⚠ WARNING: California Proposition 65 - Cancer and Reproductive Harm - www.P65Warnings.ca.gov.

SPICER AXLE 12-1/4" BRAKES AFTER JULY 1994

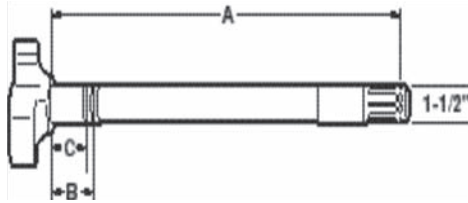

1-1/2" Dia. - 10 Spline
"A" Dimension: under head to beginning of lock ring groove

PART NO.	A	B	C	GENERAL INFORMATION
TWD CAM290L	23-1/2"	2-21/32"	2-7/32"	USE CAM KIT(S): HCK1418, HCK1412 HCK1412Z, HCK1445
TWD CAM290R				
TWD CAM256L	23-3/16"	2-21/32"	2-7/32"	
TWD CAM256R				

⚠ WARNING: California Proposition 65 - Cancer and Reproductive Harm - www.P65Warnings.ca.gov.

TRAILER AXLE 12-1/4" BRAKES

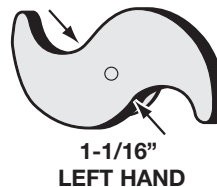
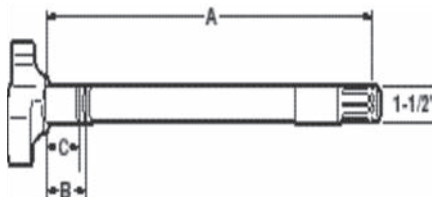

1-1/2" Dia. - 10 Spline
"A" Dimension: under head to beginning of lock ring groove

PART NO.	A	B	C	GENERAL INFORMATION
TWD CAM101L	21-1/8"	2-21/32"	2-7/32"	USE CAM KIT(S): HCK1412, HCK1445 HCK1418, HCK1426,
TWD CAM101R				

⚠ WARNING: California Proposition 65 - Cancer and Reproductive Harm - www.P65Warnings.ca.gov.



HENDRICKSON TRAILER AXLE 16-1/2" "HXS" BRAKES

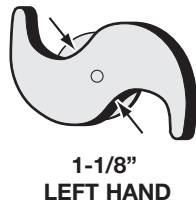
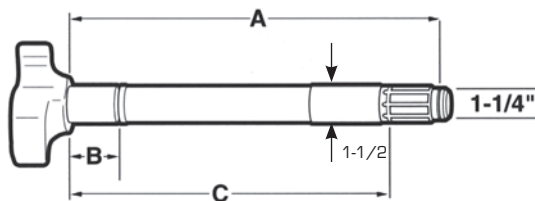

1-1/2" Dia. - 10 Spline
 "A" Dimension: under head to beginning of lock ring groove

PART NO.	A	B	C	GENERAL INFORMATION
TWD CAM348L	11-1/32"	2-5/16"	8-1/16"	HENDRICKSON INTRAAX AXLES
TWD CAM348R				

⚠ WARNING: California Proposition 65 - Cancer and Reproductive Harm - www.P65Warnings.ca.gov.

MULTIPLE APPLICATION ROCKWELL "Q" & "P" BRAKES

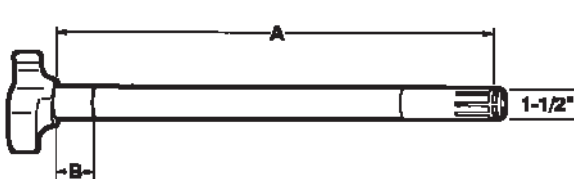

1-1/2" Dia. - 10 Spline
 "A" Dimension: under head to beginning of lock ring groove

PART NO.	A	B	GENERAL INFORMATION
TWD CAM1175LQ	11-33/64"	1-3/4"	ROCKWELL "Q" AND "P" BRAKE
TWD CAM1175RQ			

⚠ WARNING: California Proposition 65 - Cancer and Reproductive Harm - www.P65Warnings.ca.gov.

MULTIPLE APPLICATIONS

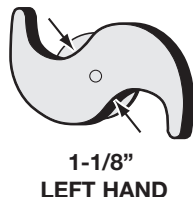
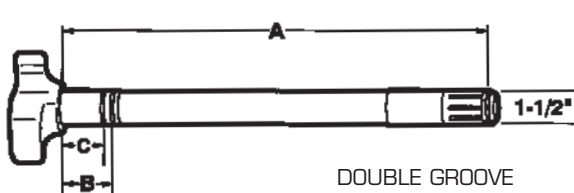

1-1/2" Dia. - 10 Spline
 "A" Dimension: under head to beginning of lock ring groove

PART NO.	A	B	C	GENERAL INFORMATION
TWD CAM114LQ	20-3/8"	2-7/32"	1-5/8"	STANDARD UNIVERSAL (ROCKWELL-STD. FORGE SPICER, FRUEHAUF)
TWD CAM114RQ				
TWD CAM119LQ	23-7/16"	2-7/32"	1-5/8"	EATON, STD. FORGE, SPICER "AIR RIDE" SUSPENSION SPICER "DANA" AXLE
TWD CAM119RQ				

⚠ WARNING: California Proposition 65 - Cancer and Reproductive Harm - www.P65Warnings.ca.gov.



ROCKWELL "Q" PLUS 16-1/2" BRAKES

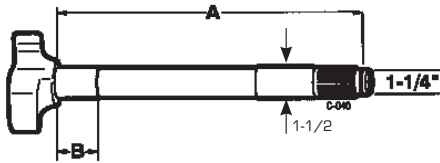

1-1/2" Dia. - 28 Spline
 "A" Dimension: under head to beginning of lock ring groove

PART NO.	A	B	GENERAL INFORMATION
TWD CAM345L	10-61/64"	1-13/16"	ROCKWELL "Q" PLUS BRAKE
TWD CAM345R			
TWD CAM198L	11-3/16"	1-13/16"	
TWD CAM198R			
TWD CAM199L	11-9/16"	1-13/16"	
TWD CAM199R			
TWD CAM228L	11-45/64"	1-13/16"	
TWD CAM228R			
TWD CAM215L	11-15/16"	1-13/16"	
TWD CAM215R			

⚠ WARNING: California Proposition 65 - Cancer and Reproductive Harm - www.P65Warnings.ca.gov.

HENDRICKSON TRAILER AXLE 16-1/2" "HXS" BRAKES

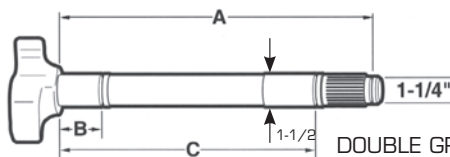

1-1/2" Dia. - 28 Spline
 "A" Dimension: under head to beginning of lock ring groove

PART NO.	A	B	C	GENERAL INFORMATION
TWD CAM349L	11-1/32"	2-5/16"	8-11/16"	HENDRICKSON "ES" BRAKE TRAILER AXLE
TWD CAM349R				

⚠ WARNING: California Proposition 65 - Cancer and Reproductive Harm - www.P65Warnings.ca.gov.

MERITOR TRAILER AXLE 16-1/2" "Q" PLUS BRAKES

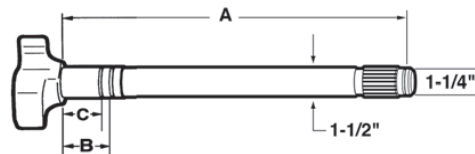

1-1/2" Dia. - 28 Spline
 "A" Dimension: under head to beginning of lock ring groove

PART NO.	A	B	C	GENERAL INFORMATION
TWD CAM154L	17-5/16"	1-63/64"	1-23/32"	MERITOR "Q" PLUS BRAKE
TWD CAM154R				
TWD CAM155L	20-13/32"	1-63/64"	1-23/32"	
TWD CAM155R				
TWD CAM156L	24-1/16"	1-63/64"	1-23/32"	
TWD CAM156R				

⚠ WARNING: California Proposition 65 - Cancer and Reproductive Harm - www.P65Warnings.ca.gov.



SPICER TRAILER AXLE 16-1/2" "ES" & "XL" BRAKES

10 SPLINE

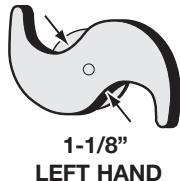
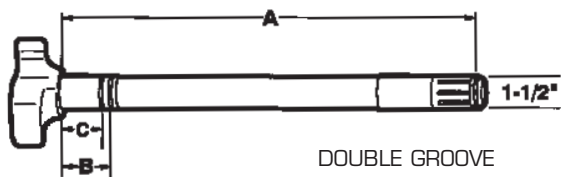

1-1/2" Dia. - 10 Spline
 "A" Dimension: under head to beginning of lock ring groove

PART NO.	A	B	C	GENERAL INFORMATION
TWD CAM303L	26-1/4"	2-7/32"	1-5/8"	SPICER "XL" TRAILER AXLE
TWD CAM303R				
TWD CAM395L	26-1/2"	2-7/32"	1-5/8"	
TWD CAM395R				

28 SPLINE

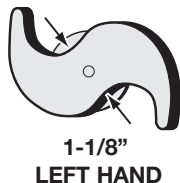
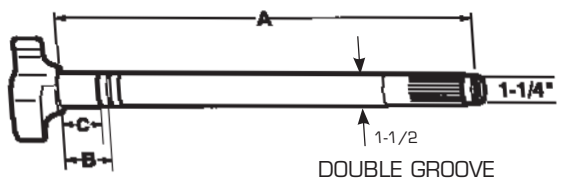

1-1/2" Dia. - 28 Spline
 "A" Dimension: under head to beginning of lock ring groove

PART NO.	A	B	C	GENERAL INFORMATION
TWD CAM158L	20-3/8"	2-7/32"	1-5/8"	ROCKWELL "G" PLUS BRAKE
TWD CAM158R				
TWD CAM159L	23-1/2"	2-7/32"	1-5/8"	
TWD CAM159R				
TWD CAM141L	24"	2-7/32"	1-5/8"	
TWD CAM141R				

10 SPLINE - AFTER SEPT. 1995

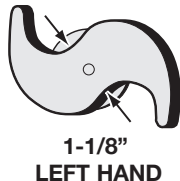
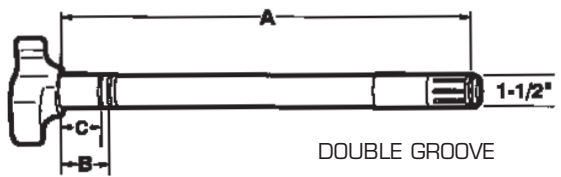

1-1/2" Dia. - 10 Spline
 "A" Dimension: under head to beginning of lock ring groove

PART NO.	A	B	C	GENERAL INFORMATION
TWD CAM388L	23-1/2"	2-7/32"	1-5/8"	SPICER "XL" TRAILER AXLE
TWD CAM388R				

⚠ WARNING: California Proposition 65 - Cancer and Reproductive Harm - www.P65Warnings.ca.gov.

SPICER TRAILER AXLE 16-1/2" "XL" BRAKES

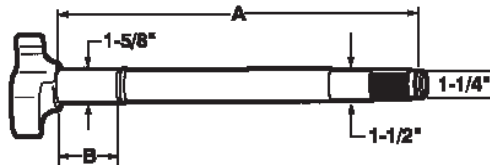

1-1/2" Dia. - 28 Spline
 "A" Dimension: under head
 to beginning of lock ring groove

PART NO.	A	B	GENERAL INFORMATION
TWD CAM250L	20-3/8"	2-7/32"	SPICER "XL" BRAKE TRAILER AXLE
TWD CAM250R			
TWD CAM379L	21-3/8"	2-7/32"	
TWD CAM379R			
TWD CAM251L	23-1/2"	2-7/32"	
TWD CAM251R			
TWD CAM210L	24-1/8"	2-7/32"	
TWD CAM210R			
TWD CAM319L	26-1/4"	2-7/32"	
TWD CAM319R			

⚠ WARNING: California Proposition 65 - Cancer and Reproductive Harm - www.P65Warnings.ca.gov.

EATON TRAILER AXLE 16-1/2" "ES" BRAKES

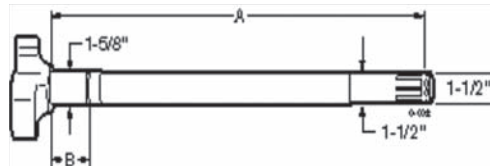

1-1/2" Dia. - 10 Spline
 "A" Dimension: under head
 to beginning of lock ring groove

PART NO.	A	B	GENERAL INFORMATION
TWD CAM146L	23-3/4"	2-7/32"	EATON "ES" BRAKE TRAILER AXLE
TWD CAM146R			

⚠ WARNING: California Proposition 65 - Cancer and Reproductive Harm - www.P65Warnings.ca.gov.

MULTIPLE APPLICATIONS



1-1/2" Dia. - 10 Spline
 "A" Dimension: under head
 to beginning of lock ring groove

PART NO.	A	B	GENERAL INFORMATION
TWD CAM123L	26-1/4"	2-7/32"	SPICER "DANA" AXLE
TWD CAM123R			
TWD CAM124L	26-1/2"	2-7/32"	SPICER "DANA" AXLE
TWD CAM124R			

⚠ WARNING: California Proposition 65 - Cancer and Reproductive Harm - www.P65Warnings.ca.gov.



SPICER TRAILER AXLE 16-1/2" & 18" BRAKES

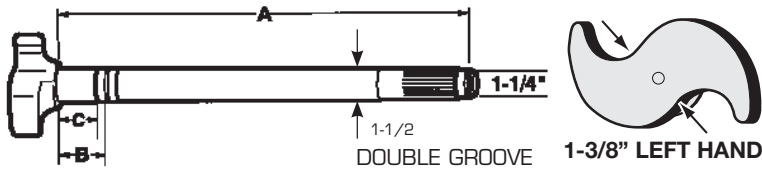

1-1/2" Dia. - 28 Spline
 "A" Dimension: under head to beginning of lock ring groove

PART NO.	A	B	C	GENERAL INFORMATION
TWD CAM209L	23-7/16"	2-7/32"	1-5/8"	AIR RIDE SUSPENSION
TWD CAM209R				

⚠ WARNING: California Proposition 65 - Cancer and Reproductive Harm - www.P65Warnings.ca.gov.

MERITOR "Q" PLUS DRIVE AXLE 16-1/2" BRAKES

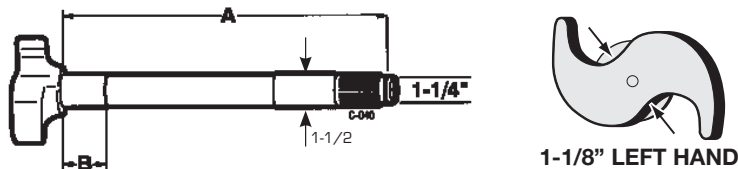

1-1/2" Dia. - 28 Spline
 "A" Dimension: under head to beginning of lock ring groove

PART NO.	A	B	GENERAL INFORMATION
TWD CAM226L	8-9/16"	1-13/16"	MERITOR "Q" PLUS DRIVE AXLE BRAKE
TWD CAM226R			
TWD CAM362L	10-13/32"	1-13/16"	
TWD CAM362R			
TWD CAM316L	12-15/16"	1-13/16"	
TWD CAM316R			
TWD CAM200L	13-3/16"	1-13/16"	
TWD CAM200R			
TWD CAM201L	13-7/16"	1-13/16"	
TWD CAM201R			
TWD CAM203L	14-3/32"	1-13/16"	
TWD CAM203R			
TWD CAM227L	14-19/32"	1-13/16"	
TWD CAM227R			
TWD CAM206L	15-11/16"	1-13/16"	
TWD CAM206R			
TWD CAM205L	15-3/16"	1-13/16"	
TWD CAM205R			
TWD CAM354L	15-13/16"	1-13/16"	
TWD CAM354R			

⚠ WARNING: California Proposition 65 - Cancer and Reproductive Harm - www.P65Warnings.ca.gov.



SPICER TRAILER AXLE 16-1/2" & 18" BRAKES

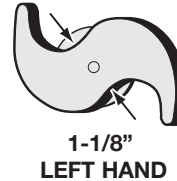
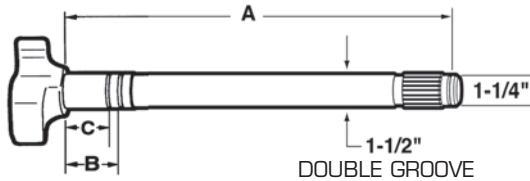

1-1/2" Dia. - 28 Spline
 "A" Dimension: under head to beginning of lock ring groove

PART NO.	A	B	C	GENERAL INFORMATION
TWD CAM138L	20-3/8"	2-7/32"	1-5/8"	SPICER "DANA" TRAILER AXLE
TWD CAM138R				

⚠ WARNING: California Proposition 65 - Cancer and Reproductive Harm - www.P65Warnings.ca.gov.

MULTI APPLICATIONS TRAILER AXLE 16-1/2" BRAKES

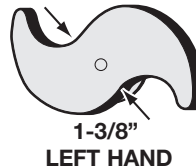
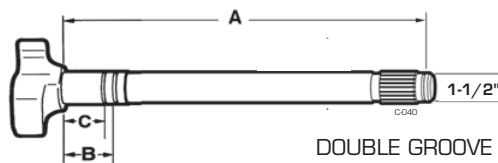

1-1/2" Dia. - 10 Spline
 "A" Dimension: under head to beginning of lock ring groove

PART NO.	A	B	C	GENERAL INFORMATION
TWD CAM220L	7-5/8"	2-7/32"	1-5/8"	MERITOR, STD.-FORGE
TWD CAM220R				

⚠ WARNING: California Proposition 65 - Cancer and Reproductive Harm - www.P65Warnings.ca.gov.

FRUEHAUF "PRO-PAR" 16-1/2" BRAKES

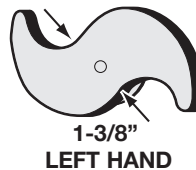
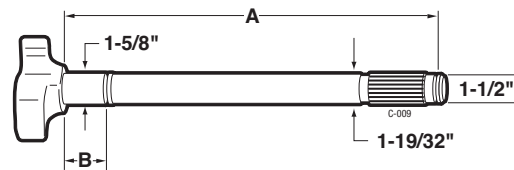

1-5/8" Dia. - 37 Spline
 "A" Dimension: under head to beginning of lock ring groove

PART NO.	A	B	GENERAL INFORMATION
TWD CAM140L	16-1/8"	2-5/32"	FRUEHAUF "PRO-PAR" BRAKE
TWD CAM140R			

⚠ WARNING: California Proposition 65 - Cancer and Reproductive Harm - www.P65Warnings.ca.gov.



FRUEHAUF "PRO-PAR" TRAILER AXLE 16-1/2" BRAKES

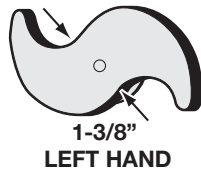
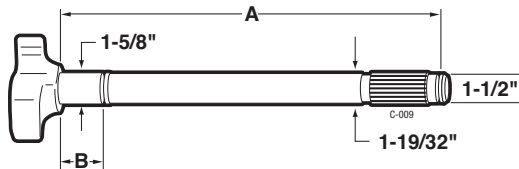

1-5/8" Dia. - 37 Spline
 "A" Dimension: under head to beginning of lock ring groove

PART NO.	A	B	GENERAL INFORMATION
TWD CAM143L	21-1/8"	2-5/32"	FRUEHAUF "PRO-PAR" TRAILER AXLE BRAKE
TWD CAM143R			

⚠ WARNING: California Proposition 65 - Cancer and Reproductive Harm - www.P65Warnings.ca.gov.

EATON TRAILER AXLE 16-1/2" "ES" BRAKES

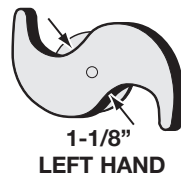
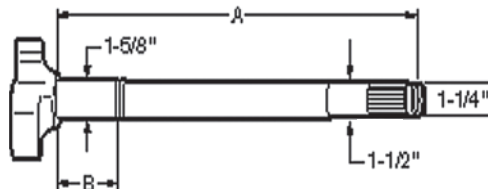

1-1/2" Dia. - 28 Spline
 "A" Dimension: under head to beginning of lock ring groove

PART NO.	A	B	GENERAL INFORMATION
TWD CAM153L	23-11/16"	2-7/32"	USE CAM KIT(S): HCK1420
TWD CAM153R			

⚠ WARNING: California Proposition 65 - Cancer and Reproductive Harm - www.P65Warnings.ca.gov.

EATON DRIVE AXLE 15" & 16-1/2" BRAKES

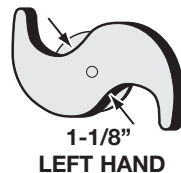
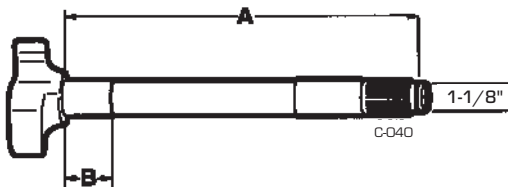

1-1/2" Dia. - 10 Spline
 "A" Dimension: under head to beginning of lock ring groove

PART NO.	A	B	GENERAL INFORMATION
TWD CAM174L	11-1/2"	1-3/4"	EATON DRIVE AXLE
TWD CAM174R			
TWD CAM389L	13-1/2"	1-3/4"	
TWD CAM389R			
TWD CAM400L	14-7/16"	1-3/4"	
TWD CAM400R			

⚠ WARNING: California Proposition 65 - Cancer and Reproductive Harm - www.P65Warnings.ca.gov.



FOR 12-1/4" DIAMETER BRAKES – SERVICES ONE AXLE

TWD CSK1004 – SPICER AND STANDARD FORGED LATE MODEL AXLES

Replaces: 43-7033, CQ67382, E-2469, K145, K345, M12KY106, R615010

	QUANTITY	PART NO.	DESCRIPTION
	2	TWD CS3000	BUSHING
	2	TWD CS3041	BUSHING
	4	TWD CS3066	SEAL
	2	TWD CS3107	WASHER
	2	TWD CS3108	WASHER
	2	TWD CS3109	WASHER
	2	TWD CS3121	WASHER
	4	TWD CS3145	LOCK RING

TWD CSK1005 – SPICER “U” BRAKES

Replaces: 43-7062, CQ67383, E-5307, K-347, R615014

	QUANTITY	PART NO.	DESCRIPTION
	2	TWD CS3021	BUSHING
	2	TWD CS3041	BUSHING
	4	TWD CS3066	SEAL
	2	TWD CS3108	WASHER
	2	TWD CS3109	WASHER
	2	TWD CS3121	WASHER
	4	TWD CS3145	LOCK RING

⚠ WARNING: California Proposition 65 - Cancer and Reproductive Harm - www.P65Warnings.ca.gov.



FOR 15" DIAMETER BRAKES – SERVICES ONE AXLE

TWD CSK1010 – EATON S.A.P. AND “ES” FRONT BRAKES

Replaces: 6-2258, 43-7060, 1008325, CQ66918, E5140, 615013

	QUANTITY	PART NO.	DESCRIPTION
	4	TWD CS3009	BUSHING
	4	TWD CS3064	SEAL
	2	TWD CS3110	WASHER
	2	TWD CS3111	WASHER
	2	TWD CS3149	LOCK RING

⚠ WARNING: California Proposition 65 - Cancer and Reproductive Harm - www.P65Warnings.ca.gov.

FOR 15 & 16-1/4" DIAMETER BRAKES

TWD CSK1022 – EATON “REDUCES ENVELOPE” AND “ES” BRAKES

Replaces: 43-7069, 127808, CQ65501, E-5501, K296, R615015

	QUANTITY	PART NO.	DESCRIPTION
	4	TWD CS3001	BUSHING
	4	TWD CS3065	SEAL
	2	TWD CS3104	WASHER
	2	TWD CS3105	WASHER
	2	TWD CS3109	WASHER
	2	TWD CS3124	WASHER
	2	TWD CS3149	LOCK RING

TWD CSK1058 – EATON S.A.P. AND “ES” FRONT BRAKES

Replaces: 6-2253, 43-7048, CQ67387, E-3993A, E-3993B, K278, KIT8042

	QUANTITY	PART NO.	DESCRIPTION
	4	TWD CS3002	BUSHING
	2	TWD CS3062	O-RING
	4	TWD CS3071	SEAL
	2	TWD CS3072	GASKET
	4	TWD CS3102	WASHER
	4	TWD CS3113	WASHER
	2	TWD CS3123	WASHER
	2	TWD CS3140	LOCK RING
	2	TWD CS3142	LOCK RING

SERVICES ONE AXLE

⚠ WARNING: California Proposition 65 - Cancer and Reproductive Harm - www.P65Warnings.ca.gov.



FOR 16-1/2" DIAMETER BRAKES

TWD CSK1024 - EATON SELF-CONTAINED DRIVE AXLE BRAKE

Replaces: 6-2259, 43-7041, 78500, CQ67326, E-2125, E-5501K80, K357, R615002

	QUANTITY	PART NO.	DESCRIPTION
<p>SERVICES ONE AXLE</p>	4	TWD CS3001	BUSHING
	4	TWD CS3065	SEAL
	2	TWD CS3104	WASHER
	2	TWD CS3105	WASHER
	2	TWD CS3109	WASHER
	2	TWD CS3149	LOCK RING
	2	TWD CS3311	COTTER PIN

TWD CSK1026 - FRUEHAUF LATE "PROPAR" BRAKE

Replaces: 6-2257, 43-7039, AXA0420-900, CQ67324, E-2090, K88, R615005

	QUANTITY	PART NO.	DESCRIPTION
<p>SERVICES ONE AXLE</p>	4	TWD CS3004	BUSHING
	2	TWD CS3043	BUSHING
	2	TWD CS3109	WASHER
	6	TWD CS3115	WASHER
	2	TWD CS3145	LOCK RING
	2	TWD CS3146	LOCK RING

TWD CSK1028 - EATON "ES" DRIVE AXLE

Replaces: 43-7068, 1008047, CQ67412, E-9053, R615018

	QUANTITY	PART NO.	DESCRIPTION
<p>SERVICES ONE AXLE</p>	2	TWD CS3001	BUSHING
	2	TWD CS3020	BUSHING
	4	TWD CS3065	SEAL
	2	TWD CS3104	WASHER
	2	TWD CS3105	WASHER
	4	TWD CS3109	WASHER
	2	TWD CS3149	LOCK RING

⚠ WARNING: California Proposition 65 - Cancer and Reproductive Harm - www.P65Warnings.ca.gov.



FOR 16-1/2" DIAMETER BRAKES (continued)

TWD CSK1035 - HENDRICKSON "INTRAAX" "ES" BRAKE

Replaces: E-11450, S-23974

	QUANTITY	PART NO.	DESCRIPTION
	2	TWD CS2000	BRACKET
	2	TWD CS3022	BUSHING
	4	TWD CS3067	SEAL
	6	TWD CS3102	WASHER
	8	TWD CS3109	WASHER
	2	TWD CS3132	WASHER
	2	TWD CS3140	LOCK RING
	2	TWD CS3145	LOCK RING

TWD CSK1038 - EATON "501" SERIES AND "ES" BRAKES

Replaces: 6-2718, 43-7043A, 1008347, CQ67354, E-2696A, K360, R615004

	QUANTITY	PART NO.	DESCRIPTION
<p>SERVICES ONE AXLE</p>	2	TWD CS3006	BUSHING
	2	TWD CS3046	BUSHING
	4	TWD CS3069	SEAL
	4	TWD CS3109	WASHER
	4	TWD CS3115	WASHER
	2	TWD CS3140	LOCK RING
	2	TWD CS3145	LOCK RING
	2	TWD CS3146	LOCK RING

TWD CSK1040 - MERITOR "Q", "Q" PLUS TRAILER AXLES WITH BOLT-ON BUSHING

Replaces: 43-7072, CQ67416, E-9079HD, BRACKET

	QUANTITY	PART NO.	DESCRIPTION
	2	TWD CS2000	BRACKET
	2	TWD CS2003	BRACKET
	4	TWD CS3069	SEAL
	2	TWD CS3102	WASHER
	2	TWD CS3103	WASHER
	2	TWD CS3114	WASHER
	2	TWD CS3125	WASHER
	2	TWD CS3140	LOCK RING
	2	TWD CS3142	LOCK RING
	2	TWD CS3148	LOCK RING

⚠ WARNING: California Proposition 65 - Cancer and Reproductive Harm - www.P65Warnings.ca.gov.



FOR 16-1/2" DIAMETER BRAKES (continued)

TWD CSK1046 - MACK WITH MERITOR 50,000# "Q" REAR AXLE

Replaces: E-5094A, CQ66939

	QUANTITY	PART NO.	DESCRIPTION
<p>SERVICES ONE AXLE</p>	4	TWD CS3002	BUSHING
	4	TWD CS3071	SEAL
	2	TWD CS3072	GASKET
	2	TWD CS3101	WASHER
	4	TWD CS3102	WASHER
	2	TWD CS3130	WASHER
	2	TWD CS3140	LOCK RING
	2	TWD CS3142	LOCK RING

TWD CSK1048 - MACK WITH MERITOR "P" AND "Q" DRIVE AXLES

Replaces: CQ67413, E-9080

	QUANTITY	PART NO.	DESCRIPTION
<p>SERVICES ONE AXLE</p>	4	TWD CS3002	BUSHING
	4	TWD CS3071	SEAL
	2	TWD CS3072	GASKET
	4	TWD CS3104	LOCK RING
	2	TWD CS3107	WASHER
	2	TWD CS3109	WASHER
	2	TWD CS3130	WASHER
	2	TWD CS3144	LOCK RING

TWD CSK1052 - MERITOR "P" DRIVE AXLES FOR 16-1/2" & 18"

Replaces: 6-2250, 43-7047, CQ67327, E-2086A, E-2086B, K81, KIT9078

	QUANTITY	PART NO.	DESCRIPTION
	4	TWD CS3002	BUSHING
	4	TWD CS3071	SEAL
	2	TWD CS3072	SEAL
	2	TWD CS3107	WASHER
	2	TWD CS3109	WASHER
	2	TWD CS3119	WASHER
	2	TWD CS3144	LOCK RING
	2	TWD CS3145	LOCK RING

⚠ WARNING: California Proposition 65 - Cancer and Reproductive Harm - www.P65Warnings.ca.gov.



FOR 16-1/2" DIAMETER BRAKES (continued)

TWD CSK1056 - FRUEHAUF LATE "PROPAR" BRAKE

Replaces: 6-2249, 43-7044, E-2088AHD, K368, KIT8046

	QUANTITY	PART NO.	DESCRIPTION
 <p>SERVICES ONE AXLE</p>	2	TWD CS2000	BRACKET
	2	TWD CS3028	BUSHING
	8	TWD CS3103	WASHER
	2	TWD CS3144	SEAL
	4	TWD CS3145	LOCK RING

TWD CSK1060 - STANDARD FORGE AND SPICER LATE MODEL AXLES

Replaces: 6-2254, 43-7032, 43-7037B, CQ67332, E2287, K343, M16K120, R615008

	QUANTITY	PART NO.	DESCRIPTION
 <p>SERVICES ONE AXLE</p>	2	TWD CS3000	BUSHING
	2	TWD CS3041	BUSHING
	4	TWD CS3066	SEAL
	4	TWD CS3102	WASHER
	2	TWD CS3108	WASHER
	2	TWD CS3109	WASHER
	2	TWD CS3116	WASHER
	2	TWD CS3140	LOCK RING
	2	TWD CS3142	LOCK RING
	4	TWD CS3145	LOCK RING

TWD CSK1062 - STANDARD FORGE AND SPICER LATE MODEL AXLES

Replaces: 6-2255, 43-7030, CQ67353(2), E-2680, K99, R615007

	QUANTITY	PART NO.	DESCRIPTION
 <p>SERVICES ONE AXLE</p>	2	TWD CS3021	BRONZE BUSHING
	2	TWD CS3040	BUSHING
	4	TWD CS3062	O-RING
	4	TWD CS3065	SEAL
	2	TWD CS3109	WASHER
	2	TWD CS3116	WASHER
	2	TWD CS3119	WASHER
	4	TWD CS3145	LOCK RING

WARNING: California Proposition 65 - Cancer and Reproductive Harm - www.P65Warnings.ca.gov.



FOR 16-1/2" DIAMETER BRAKES (continued)

TWD CSK1064 - SPICER BRAKE WITH 1-5/8" CAMSHAFT

Replaces: CQ67111, E-9790A, R615019

	QUANTITY	PART NO.	DESCRIPTION
<p>SERVICES ONE AXLE</p>	2	TWD CS3023	BRONZE BUSHING
	2	TWD CS3042	BUSHING
	4	TWD CS3069	SEAL
	4	TWD CS3102	WASHER
	2	TWD CS3109	WASHER
	2	TWD CS3127	WASHER
	2	TWD CS3129	WASHER
	2	TWD CS3140	LOCK RING
	2	TWD CS3146	LOCK RING

TWD CSK1068 - MERITOR "Q" AND "Q" PLUS TRAILER AXLE MINOR KITS

Replaces: 43-7072A-1, CQ66941, E-6078, K313, KIT8289

	QUANTITY	PART NO.	DESCRIPTION
<p>SERVICES ONE AXLE</p>	1	TWD CS2003	BRACKET
	2	TWD CS3069	SEAL
	1	TWD CS3116	WASHER
	1	TWD CS3125	WASHER
	1	TWD CS3148	LOCK RING
	4	-	BOLT

TWD CSK1072 - MERITOR 4000-6000 TRAILER AXLE (ALTERNATE FOR CSK1030)

Replaces: E-3989AHD

	QUANTITY	PART NO.	DESCRIPTION
<p>SERVICES ONE AXLE</p>	2	TWD CS2000	BRACKET
	2	TWD CS3006	NYLON BUSHING
	4	TWD CS3068	SEAL
	2	TWD CS3102	WASHER
	2	TWD CS3103	WASHER
	4	TWD CS3106	WASHER
	2	TWD CS3140	LOCK RING
	2	TWD CS3142	LOCK RING
	2	TWD CS3146	LOCK RING

⚠ WARNING: California Proposition 65 - Cancer and Reproductive Harm - www.P65Warnings.ca.gov.



FOR 16-1/2" DIAMETER BRAKES (continued)

TWD CSK1074 - STANDARD FORGE AND KERSHAW (DANA) EARLY AXLES

Replaces: 6-2712, 43-7029, CQ67331, E2087, K346, R615009

	QUANTITY	PART NO.	DESCRIPTION
<p>SERVICES ONE AXLE</p>	2	TWD CS3000	BUSHING
	2	TWD CS3001	BUSHING
	4	TWD CS3066	SEAL
	4	TWD CS3071	SEAL
	2	TWD CS3109	WASHER
	2	TWD CS3116	WASHER
	2	TWD CS3119	WASHER
	4	TWD CS3145	LOCK RING

TWD CSK1076 - FOR 16-1/2" DIAMETER BRAKES

Replaces: 43-7032A

	QUANTITY	PART NO.	DESCRIPTION
<p>SERVICES ONE AXLE</p>	2	TWD CS3021	BUSHING
	2	TWD CS3041	BUSHING
	4	TWD CS3066	WASHER
	2	TWD CS3107	WASHER
	2	TWD CS3109	WASHER
	2	TWD CS3116	WASHER
	2	TWD CS3140	LOCK RING
	4	TWD CS3145	LOCK RING

⚠ WARNING: California Proposition 65 - Cancer and Reproductive Harm - www.P65Warnings.ca.gov.



FOR 16-1/2" DIAMETER BRAKES (continued)

TWD CSK1080 - FOR 12-1/4" & 16-1/2" DIAMETER BRAKES, 1-5/8" I.D. AT SPIDER SPICER AXLES

Replaces: 43-7118

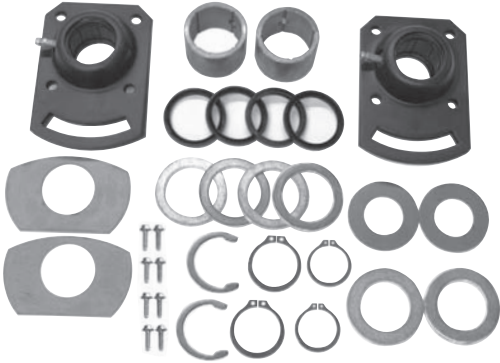
	QUANTITY	PART NO.	DESCRIPTION
 <p>SERVICES ONE AXLE</p>	1	TWD CS2014L	BRACKET
	1	TWD CS2014R	BRACKET
	1	TWD CS3140	LOCK RING
	1	TWD CS3145	LOCK RING
	4	TWD CS3069	SEAL
	2	*	LOCK RING
	2	*	BUSHING
	4	*	WASHER
	2	*	WASHER
	2	*	WASHER
	2	*	WASHER
	8	*	SELF TAPPING SCREW

TWD CSK1081 - FOR 12-1/4" & 16-1/2" DIAMETER BRAKES, 1-1/2" I.D. AT SPIDER SPICER AXLE

Replaces: 43-7117







	QUANTITY	PART NO.	DESCRIPTION
 <p>SERVICES ONE AXLE</p>	1	TWD CS2014L	BRACKET
	1	TWD CS2014R	BRACKET
	2	TWD CS3021	BUSHING
	2	TWD CS3109	WASHER
	2	TWD CS3116	WASHER
	2	TWD CS3121	WASHER
	4	TWD CS3140	LOCK RING
	2	TWD CS3145	LOCK RING
	2	*	WASHER
	2	*	WASHER
	2	*	WASHER
	8	*	SELF TAPPING SCREW
	4	*	SEAL

*Sold in kit only

⚠ WARNING: California Proposition 65 - Cancer and Reproductive Harm - www.P65Warnings.ca.gov.





BUSHING & SUPPORT ASSEMBLIES - SERVICES ONE AXLE

	PART NO.	DESCRIPTION		PART NO.	DESCRIPTION
	TWD CS2000	For multi applications Replaces: A-3105-V-282, C66549, E-1318AHD, L2854, Zerk screw in bushing.		TWD CS2020	For multi applications Replaces: 30-1358, E1318A Zerk screw in plate.
	TWD CS2001	For Spicer-Std Forge 16-1/2" Brake. Use with CS3041 Replaces: 30-1357, 209999-018, E-2104, L1198, M16WH113X, R630003		TWD CS2002	For Spicer-Std Forge Brakes Replaces: 30-1385, 209108-001, E-2365, L2387
	TWD CS2003	For Meritor "G" and "G" PLUS 16-1/2" Trailer Axles. Powdered Metal. I.D.: 1-5/8", Length: 1-13/16", Replaces: A-3105-L-1078, C63140, E-6076, L-3033/43		TWD CS2014L TWD CS2014R	Redesigned cam bracket assembly with greaseable, reinforced bushing and three seal lips limiting contaminants. Replaces: 31-1341L & 31-1341R



⚠ WARNING: California Proposition 65 - Cancer and Reproductive Harm - www.P65Warnings.ca.gov.

AXLE LOCK WASHERS

	PART NO.	DESCRIPTION		PART NO.	DESCRIPTION
	TWD CS3303	Lock Washer "Trade" Axles O.D.: 3-15/16" I.D.: 2-41/64" Thickness: 1/4" Replaces: 12-392, 105107, 1229-V-1600, E573, L177, M10HN100, R000573		TWD CS3302	Tab Lock Washer with 5/32" Tab O.D.: 4-1/32" I.D.: 2-41/64" Thickness: 1/16" Replaces: 12-394, 105106, C002237, E-2237, L1327, M10HN151, R002237

⚠ WARNING: California Proposition 65 - Cancer and Reproductive Harm - www.P65Warnings.ca.gov.

AXLE SPINDLE NUTS

	PART NO.	DESCRIPTION		PART NO.	DESCRIPTION
	TWD CS3301	Outer Nut "Trade" Axles, Use Wrench CS3490, Across Flats: 3-1/4", Thread: 2-5/8" - 16, Thickness: 3/8", Replaces: 12-393, 1227-B-756, 103102-001, 820395, C65336, E-572, L178, M10HN102, R000572		TWD CS3300	Inner Nut "Trade" Axles, Use Wrench CS3490, Across Flats: 3-13/16", Thread: 2-5/8" - 16, Thickness: 3/8", Replaces: 12-391, 1227-C-549, 103104-001, 820394, C65334, E-540, L176, M10HN101, R000540

⚠ WARNING: California Proposition 65 - Cancer and Reproductive Harm - www.P65Warnings.ca.gov.



CAMSHAFT TUBE ENCLOSURES
FOR 1-1/2" DIAMETER CAMSHAFTS



PART NO.	CAM TUBE DIMENSION	APPLICATION
TWD CSK4101	1-7/8" O.D. X 1-1/2" I.D. X 17-3/4"	FOR CAMS 20-3/8" LONG
TWD CSK4102	1-7/8" O.D. X 1-1/2" I.D. 21"	FOR CAMS 23-3/4" LONG
TWD CSK4104	1-7/8" O.D. X 1-1/2" I.D. X 19-1/4"	FOR CAMS 23-3/4" LONG
TWD CSK4112	1-7/8" O.D. X 1-1/2" I.D. X 20-1/2"	FOR CAMS 23-1/4" LONG
TWD CSK4113	1-7/8" O.D. X 1-1/2" I.D. X 18-1/2"	FOR CAMS 21-1/8" LONG
TWD CSK4119	1-7/8" O.D. X 1-1/2" I.D. X 19-5/16"	FOR CAMS 22-1/16" LONG
TWD CSK4120	1-7/8" O.D. X 1-1/2" I.D. X 23-5/8"	FOR CAMS 26-1/4" LONG
TWD CSK4129	1-7/8" O.D. X 1-1/2" I.D. X 23-7/8"	FOR CAMS 26-1/16" LONG

FOR 1-5/8" DIAMETER CAMSHAFTS

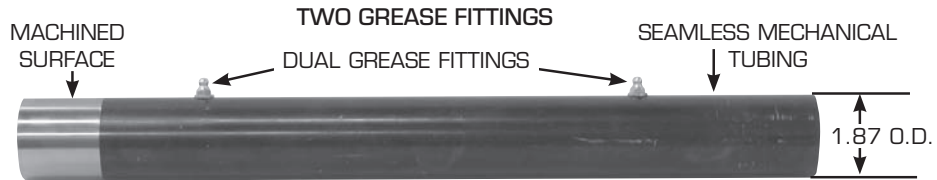

PART NO.	CAM TUBE DIMENSION	APPLICATION
TWD CSK4130	2" O.D. X 1-5/8" I.D. X 13-3/4"	FRUEHAUF CAMS 16-1/8" LONG
TWD CSK4139	2" O.D. X 1-5/8" I.D. X 14-3/16"	FOR CAMS 17-3/8", 1-5/8" & 1-1/2" SUPPORT END
TWD CSK4141	2" O.D. X 1-5/8" I.D. X 21-5/8"	FOR CAMS 24-1/8", 1-5/8" & 1-1/2" SUPPORT END
TWD CSK4150AM	2" O.D. X 1-5/8" I.D. X 20-1/2"	FOR CAMS 24-1/8", 1-5/8" & 1-1/2" SUPPORT END
TWD CSK4157	2" O.D. X 1-5/8" I.D. X 21"	FOR CAMS 24", 1-5/8" & 1-1/2" SUPPORT END
TWD CSK4166	2" O.D. X 1-5/8" I.D. X 8-13/16"	FOR CAMS 11-3/16" LONG

FOR 1-1/2" DIAMETER CAMSHAFTS

PART NO.	CAM TUBE DIMENSION	APPLICATION
TWD CSK4178	1-7/8" X 1-1/2" I.D. X 17.8"	FOR CAMS 17-7/8" LONG
TWD CSK4185	1-7/8" X 1-1/2" I.D. X 18.5"	FOR CAMS 18-1/2" LONG
TWD CSK4208	1-7/8" X 1-1/2" I.D. X 20.8"	FOR CAMS 20-7/8" LONG
TWD CSK4213	1-7/8" X 1-1/2" I.D. X 21.3"	FOR CAMS 21-1/2" LONG

⚠ WARNING: California Proposition 65 - Cancer and Reproductive Harm - www.P65Warnings.ca.gov.



BRACKETS

	PART NO.	O.D.	DESCRIPTION
	TWD CSK4100	1-7/8"	UNIVERSAL
	TWD CSK4105	1-7/8"	UNIVERSAL, 4" X 4" X 1/8" THK.
	TWD CSK4106	2"	
	TWD CSK4167	2"	FRUEHAUF PROPAR 4" X 4" X 1/8" THK.

⚠ WARNING: California Proposition 65 - Cancer and Reproductive Harm - www.P65Warnings.ca.gov.

ADAPTER PLATES

	PART NO.	O.D.	DESCRIPTION
	TWD CSK4115-1	1-7/8"	ADAPTERS WITH HALDEX ADJUSTER CONTROL ARM
	TWD CSK4115-2	2"	

⚠ WARNING: California Proposition 65 - Cancer and Reproductive Harm - www.P65Warnings.ca.gov.

BUSHINGS

	PART NO.	DESCRIPTION
	TWD CS5000	WITH HOLES 1-1/2" I.D. 1-5/8" O.D.

⚠ WARNING: California Proposition 65 - Cancer and Reproductive Harm - www.P65Warnings.ca.gov.



BRAKE SHOES PART NUMBERING SYSTEM

Haldex® Part Number Format



- R = Reman. Shoe
- G = Reman. Gripper Kit- Boxed (2-Shoes and Hardware Kit)
- N = New Lined Shoe
- J = New Gripper Kit- Boxed (2-Shoes and Hardware Kit)

Haldex® Shoe Core Identifier

FMSI Number (Friction Materials Standards Institute, Inc.)

Haldex® Product Mix Designator/Brake Block Description

GC	23,000 lbs., 2020 Organic Material
GD	23,000 lbs., 2016 Organic Material
GF	20,000 lbs., 2008 Organic Material
GG	23,000 lbs., 2020 Organic Material- RSD Systems Compliant
GM	25,000 lbs., 2040 Semi-Metallic Material
GN	20,000 lbs., 2017 Organic Material
GP	26,000 lbs., 2030 Organic Material
GR	20,000 lbs., 2015 Organic Material- RSD Systems Compliant
GZ	23,000 lbs., 2035 Semi-Metallic Material



Gold Force® Part Number Format



- 6N = New Kit (2-Shoes and Hardware Kit)

Gross Axle Weight Rating (GAWR)

U80	20,000 lbs.
U83	23,000 lbs.
U93	23,000 lbs. Ceramic
U95	23,000 lbs. Severe Duty

Popular Gold Force® Shoe Styles (FMSI)

046	Meritor (4707D) 16-1/2" x 7"
051	Meritor (4515ED) 16-1/2" x 7"
059	Meritor (4702) 15" x 4"
'077	Eaton (4709D) 16-1/2" x 7"



POPULAR EATON - AIR/SINGLE WEB BRAKES +

15" x 4" STANDARD STEER AXLE

RIVET HOLE SPACING ACROSS WIDTH (CENTER TO CENTER): 2-3/4"
 WIDTH: 4"
 FMSI NO.: 1308



Mfg.	Product	Hardware	20K Standard	23K Premium	23K Serv/Combo	Premium
			Part No.	Part No.	Part No.	Part No.
Haldex	Relined Shoes	MBI CQ66917	-	MBI GR1308ER	MBI GC1308ER	MBI GG1308ER
Haldex	Relined-Gripper Kits	MBI CQ66917	-	MBI GR1308EG	MBI GC1308EG	MBI GG1308EG
Haldex	New Lined Shoes	MBI CQ66917	MBI GF1308EN	MBI GR1308EN	MBI GC1308EN	MBI GG1308EN
Haldex	New-Gripper Kits	MBI CQ66917	MBI GF1308EJ	MBI GR1308EJ	MBI GC1308EJ	MBI GG1308EJ

15" x 4" EXTENDED SERVICE STEER AXLE

RIVET HOLE SPACING ACROSS WIDTH (CENTER TO CENTER): 2"
 WIDTH: 4"
 FMSI NO.: 1443



Mfg.	Product	Hardware	20K Standard	23K Economy	23K Serv/Combo	23K Premium
			Part No.	Part No.	Part No.	Part No.
Haldex	Relined Shoes	MBI CQ66917	-	-	MBI GC1443ER	MBI GG1443ER
Haldex	Relined-Gripper Kits	MBI CQ66917	-	-	MBI GC1443EG	MBI GG1443EG
Haldex	New Lined Shoes	MBI CQ66917	MBI GF1443EN	-	-	MBI GG1443EN
Haldex	New-Gripper Kits	MBI CQ66917	MBI GF1443EJ	-	-	MBI GG1443EJ
Meritor	New-Eagle Grip Kits	TWD BHK009	-	TWD 1443E23	-	-

16-1/2" x 7" LOW MOUNT

WIDTH: 7"
 FMSI NO.: 4311



Mfg.	Product	Hardware	20K Economy	20K Standard	20K Premium	23K Economy	23K Serv/Combo	23K Premium	25K Severe	26K Severe
			Part No.	Part No.	Part No.	Part No.	Part No.	Part No.	Part No.	Part No.
Haldex	Relined Shoes	MBI CQ67319	MBI GN4311ER	MBI GF4311ER	MBI GR4311ER	MBI GD4311ER	MBI GC4311ER	MBI GG4311ER	MBI GM4311ER	MBI GP4311ER
Haldex	Relined-Gripper Kits	MBI CQ67319	MBI GN4311EG	MBI GF4311EG	MBI GR4311EG	MBI GD4311EG	MBI GC4311EG	MBI GG4311EG	MBI GM4311EG	-
Haldex	New Lined Shoes	MBI CQ67319	MBI GN4311EN	MBI GF4311EN	MBI GR4311EN	MBI GD4311EN	MBI GC4311EN	MBI GG4311EN	-	MBI GP4311EN
Haldex	New-Gripper Kits	MBI CQ67319	MBI GN4311EJ	MBI GF4311EJ	MBI GR4311EJ	MBI GD4311EJ	MBI GC4311EJ	MBI GG4311EJ	-	-
Meritor	New-Eagle Grip Kits	TWD BHK003	-	-	-	TWD 4311E23	-	-	-	-

⚠ WARNING: California Proposition 65 - Cancer and Reproductive Harm - www.P65Warnings.ca.gov.



POPULAR EATON - AIR/DOUBLE WEB AND CAST BRAKES +

16-1/2" X 7" EATON (ES)

WIDTH: 7"
FMSI NO.: 4709



Mfg.	Product	Hardware	20K Economy	20K Standard	20K Premium	23K Economy	23K Serv/ Combo	23K Premium	23K Severe	26K Severe
			Part No.	Part No.	Part No.	Part No.	Part No.	Part No.	Part No.	Part No.
Haldex	Relined Shoes	MBI CQ65481	MBI GN4709ESR	MBI GF4709ESR	MBI GR4709ESR	MBI GD4709ESR	MBI GC4709ESR	MBI GG4709ESR	MBI GZ4709ESR	MBI GP4709ESR
Haldex	Relined-Gripper Kits	MBI CQ65481	MBI GN4709ESG	MBI GF4709ESG	MBI GR4709ESG	MBI GD4709ESG	MBI GC4709ESG	MBI GG4709ESG	MBI GZ4709ESG	MBI GP4709ESG
Haldex	New Lined Shoes	MBI CQ65481	MBI GN4709ESN	MBI GF4709ESN	MBI GR4709ESN	MBI GD4709ESN	MBI GC4709ESN	MBI GG4709ESN	-	-
Haldex	New-Gripper Kits	MBI CQ65481	MBI GN4709ESJ	MBI GF4709ESJ	MBI GR4709ESJ	MBI GD4709ESJ	MBI GC4709ESJ	MBI GG4709ESJ	-	-

16-1/2" X 7" EATON (ESII)

WIDTH: 7"
FMSI NO.: 4709



Mfg.	Product	Hardware	20K Economy	20K Standard	20K Premium	23K Economy	23K Serv/ Combo	23K Premium	23K Severe	26K Severe
			Part No.	Part No.	Part No.	Part No.	Part No.	Part No.	Part No.	Part No.
Haldex	Relined Shoes	MBI CQ65477	MBI GN4709ES2R	MBI GF4709ES2R	MBI GR4709ES2R	MBI GD4709ES2R	MBI GC4709ES2R	MBI GG4709ES2R	MBI GZ4709ES2R	MBI GP4709ES2R
Haldex	Relined-Gripper Kits	MBI CQ65477	MBI GN4709ES2G	MBI GF4709ES2G	MBI GR4709ES2G	MBI GD4709ES2G	MBI GC4709ES2G	MBI GG4709ES2G	MBI GZ4709ES2G	MBI GP4709ES2G
Haldex	New Lined Shoes	MBI CQ65477	MBI GN4709ES2N	MBI GF4709ES2N	MBI GR4709ES2N	MBI GD4709ES2N	MBI GC4709ES2N	MBI GG4709ES2N	-	-
Haldex	New-Gripper Kits	MBI CQ65477	MBI GN4709ES2J	MBI GF4709ES2J	MBI GR4709ES2J	MBI GD4709ES2J	MBI GC4709ES2J	MBI GG4709ES2J	MBI GZ4709ES2J	-
Gold Force	New Kits-Semi Met.	TWD BHK077	-	TWD 077U80-6N	-	-	-	TWD 077U83-6N	TWD 077U93-6N	-
Gold Force	New Kits-Ceramic	TWD BHK077	-	-	-	-	-	-	TWD 077U95-6N	-
Meritor	New-Eagle Grip Kits	TWD BHK077	TWD 4709E20	-	-	TWD 4709E23	-	TWD 4709EA23	-	-

⚠ WARNING: California Proposition 65 - Cancer and Reproductive Harm - www.PG5Warnings.ca.gov.

BRAKE SHOES

A

BRAKE FOUNDATION PARTS



POPULAR MERITOR - AIR/SINGLE WEB BRAKES +

15" X 4" MERITOR (Q LATE STYLE)

WIDTH: 4"
FMSI NO.: 1308



Mfg.	Product	Hardware	20K Economy	20K Standard	20K Premium	23K Economy	23K Serv/Combo	23K Premium
			Part No.	Part No.	Part No.	Part No.	Part No.	Part No.
Haldex	Relined Shoes	MBI CQ69001	-	-	MBI GR1308Q2R	-	MBI GC1308Q2R	MBI GG1308Q2R
Haldex	Relined-Gripper Kits	MBI CQ69001	-	-	MBI GR1308Q2G	-	MBI GC1308Q2G	MBI GG1308Q2G
Haldex	New Lined Shoes	MBI CQ69001	-	MBI GF1308Q2N	MBI GR1308Q2N	-	MBI GC1308Q2N	MBI GG1308Q2N
Haldex	New-Gripper Kits	MBI CQ69001	-	MBI GF1308Q2J	MBI GR1308Q2J	-	MBI GC1308Q2J	MBI GG1308Q2J

15" X 4" MERITOR (Q PLUS)

WIDTH: 4"
FMSI NO.: 4702



Mfg.	Product	Hardware	20K Standard	20K Premium	23K Economy	23K Serv/Combo	23K Premium
			Part No.	Part No.	Part No.	Part No.	Part No.
Haldex	Relined Shoes	MBI CQ65642	-	MBI GR4702QR	-	MBI GC4702QR	MBI GG4702QR
Haldex	Relined-Gripper Kits	MBI CQ65642	-	MBI GR4702QG	-	MBI GC4702QG	MBI GG4702QG
Haldex	New Lined Shoes	MBI CQ65642	MBI GF4702QN	MBI GR4702QN	-	MBI GC4702QN	MBI GG4702QN
Haldex	New-Gripper Kits	MBI CQ65642	MBI GF4702QJ	MBI GR4702QJ	-	-	MBI GG4702QJ
Gold Force	New Kits-Semi Met.	TWD BHK059	-	-	-	TWD 059U83-6N	-
Gold Force	New Kits-Ceramic	TWD BHK059	-	-	-	-	TWD 059U93-6N
Meritor	New-Eagle Grip Kits	TWD BHK059	-	TWD 4702EA20	TWD 4702E23	-	-

⚠ WARNING: California Proposition 65 - Cancer and Reproductive Harm - www.P65Warnings.ca.gov.



POPULAR MERITOR - AIR/SINGLE WEB BRAKES + (continued)

16-1/2" X 7" MERITOR (Q)

SHOE HAS HUMP IN WEB AND INSIDE RIVET SPACING ACROSS WIDTH OF 2-3/4"
 WIDTH: 7"
 FMSI NO.: 4515



Mfg.	Product	Hardware	20K	20K	20K	23K	23K	23K	23K	25K	26K
			Economy	Standard	Premium	Economy	Serv/ Combo	Premium	Severe	Severe	Severe
			Part No.	Part No.	Part No.	Part No.	Part No.	Part No.	Part No.	Part No.	Part No.
Haldex	Relined Shoes	MBI CQ66867	MBI GN4515QR	MBI GF4515QR	MBI GR4515QR	MBI GD4515QR	MBI GC4515QR	MBI GG4515QR	MBI GZ4515QR	MBI GM4515QR	MBI GP4515QR
Haldex	Relined-Gripper Kits	MBI CQ66867	MBI GN4515QG	MBI GF4515QG	MBI GR4515QG	MBI GD4515QG	MBI GC4515QG	MBI GG4515QG	MBI GZ4515QG	MBI GM4515QG	MBI GP4515QG
Haldex	New Lined Shoes	MBI CQ66867	MBI GN4515QN	MBI GF4515QN	MBI GR4515QN	MBI GD4515QN	MBI GC4515QN	MBI GG4515QN	MBI GZ4515QN	MBI GM4515QN	MBI GP4515QN
Haldex	New-Gripper Kits	MBI CQ66867	MBI GN4515QJ	MBI GF4515QJ	MBI GR4515QJ	MBI GD4515QJ	MBI GC4515QJ	MBI GG4515QJ	-	-	MBI GP4515QJ
Gold Force	New Kits-Semi Met.	TWD BHK051	-	MBI 051U80-6N	-	-	-	TWD 051U83-6N	TWD 051U95-6N	-	-
Gold Force	New Kits-Ceramic	TWD BHK051	-	-	-	-	-	TWD 051U93-6N	-	-	-
Meritor	New-Eagle Grip Kits	TWD BHK051	TWD 4515E20	-	-	TWD 4515E23	-	TWD 4515EA23	-	-	-

⚠ WARNING: California Proposition 65 - Cancer and Reproductive Harm - www.P65Warnings.ca.gov.



POPULAR MERITOR - AIR/DOUBLE WEB AND CAST BRAKES +

**16-1/2" X 7" MERITOR
(Q PLUS- Current Design)**

SHOE HAS NO HUMP IN WEB AND INSIDE RIVET SPACING ACROSS WIDTH OF 2-3/4" WIDTH: 7"
FMSI NO.: 4707



Mfg.	Product	Hardware	20K	20K	20K	23K	23K Serv/	23K	23K	25K	26K
			Economy	Standard	Premium	Economy	Combo	Premium	Severe	Severe	Severe
Part No.	Part No.	Part No.	Part No.	Part No.	Part No.	Part No.	Part No.	Part No.	Part No.	Part No.	Part No.
Haldex	Relined Shoes	MBI CQ66867	MBI GN4707QR	MBI GF4707QR	MBI GR4707QR	MBI GG4707QR	MBI GZ4707QR	MBI GG4707QR	MBI GZ4707QR	MBI GM4707QR	MBI GP4707QR
Haldex	Relined-Gripper Kits	MBI CQ66867	MBI GN4707QG	MBI GF4707QG	MBI GR4707QG	MBI GG4707QG	MBI GZ4707QG	MBI GG4707QG	MBI GZ4707QG	MBI GM4707QG	MBI GP4707QG
Haldex	New Lined Shoes	MBI CQ66867	MBI GN4707QN	MBI GF4707QN	MBI GR4707QN	MBI GG4707QN	MBI GZ4707QN	MBI GG4707QN	MBI GZ4707QN	-	MBI GP4707QN
Haldex	New-Gripper Kits	MBI CQ66867	MBI GN4707QJ	MBI GF4707QJ	MBI GR4707QJ	MBI GG4707QJ	-	MBI GG4707QJ	-	-	MBI GP4707QJ
Gold Force	New Kits-Semi-Met.	TWD BHK051	-	TWD 046U80-6N	-	TWD 046U83-6N	TWD 046U95-6N	TWD 046U83-6N	TWD 046U95-6N	-	-
Gold Force	New Kits-Ceramic	TWD BHK051	-	-	TWD 046U90-6N	TWD 046U93-6N	-	TWD 046U93-6N	-	-	-
Meritor	New-Eagle Grip Kits	TWD BHK051	TWD 4707E20	-	TWD 4707EA20	TWD 4707EA23	TWD 4707ESD23	TWD 4707EA23	TWD 4707ESD23	-	-

⚠ WARNING: California Proposition 65 - Cancer and Reproductive Harm - www.P65Warnings.ca.gov.



BRAKE DRUMS



PART NO.	BRAKE SIZE	OVERALL DEPTH	WIDTH OF BRAKE SURFACE	PILOT DIA.	BOLT CIRCLE DIA.	BOLT HOLES NO.	SIZE	APPLICATIONS	REPLACES		
									GUNITE	MERITOR	WEBB
TWD 60000-018	16.5" X 7.00"	10.56	7.56	8.78	11.25	10	1	Truck Rear Axles, Trailer Axles	3922X	-	56864B
TWD X60046	16.50" X 7.00"	9.50	7.56	9.44	11.25	10	0.84	Trailer Axles	2705	03-012582-002	62200
TWD X60076	16.50" X 7.00"	8.75	7.50	9.50	11.25	5/6	.81/.65	Trailer Axles	2546C	13-120586-002	68765
TWD X60077	16.50" X 7.00"	8.74	7.50	9.50	11.25	10	0.81	Trailer Axles	3018A	03-122518-002	68730
TWD X60114	16.50" X 7.00"	8.18	7.40	9.44	11.00	5/6	.78/.65	Truck Rear Axles, Trailer Axles	2983C	03-122222-002	62997
TWD X60420	16.50" X 7.00"	10.59	7.75	9.00	11.25	10	0.81	Truck Rear Axles	3141	03-122550-002	66895B
TWD 3022BX	16.50" X 6.00"	7.43	6.40	11.25	12.75	6	0.78	Front/Rear Truck Axles	-	03-123427-002	65266B
TWD X60434	16.50" X 7.00"	8.74	7.58	10.50	12.75	5/6	0.78	Ford Rear Axles	2997D	03-123430-002 03-122009-002	62997
TWD X60481	16.50" X 7.00"	7.93	7.31	11.00	12.75	6	0.65	Mack Rear Axle	8656	03-120743-002 03-122600-002	68897
TWD X60611	16.50" X 7.00"	10.59	7.63	8.53	11.25	10	0.81	Freightliner Tag Axles	3166	03-122978-002	66893
TWD X60613	16.50" X 7.00"	8.46	7.41	11.25	12.75	5/6	0.78	Truck Rear Axles	3295A	03-122490-002 03-122683-002	68981B
TWD X60789	16.50" X 7.00"	10.59	7.75	9.00	10.82	8	1.00	Truck Front/Rear Axles	3141B	03-123409-002	66875B
TWD X60794	16.50" X 7.00"	10.56	7.60	8.78	11.25	10	1.25	Truck Rear Axles, Trailer Axles	3600A	03-123207-002	66864
TWD X61223B	15.00" X 4.00"	8.79	4.78	8.78	11.25	10	1.25	Truck Front Axles	3721AX	85-123254-002 85-123366-002	61528B
TWD X61225B	15.00" X 4.00"	9.18	4.66	8.78	11.25	10	1.25	Truck Front Axles	3800X	03-123448-002	65554B

*B Means Machine Balanced

⚠ WARNING: California Proposition 65 - Cancer and Reproductive Harm - www.P65Warnings.ca.gov.



BRAKE DRUMS (continued)

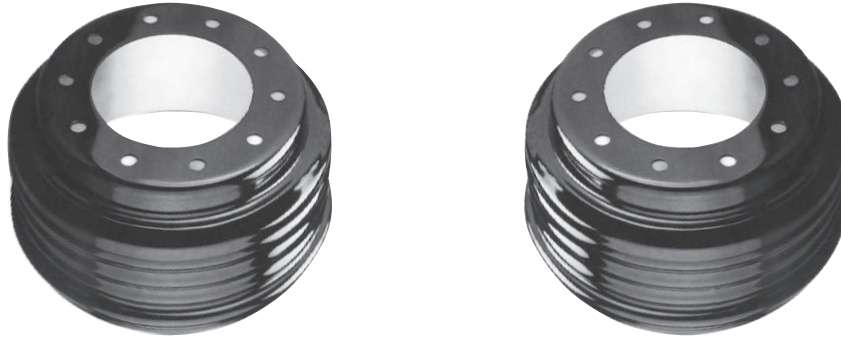

PART NO.	BRAKE SIZE	OVERALL DEPTH	WIDTH OF BRAKE SURFACE	PILOT DIA.	BOLT CIRCLE DIA.	BOLT HOLES NO.	SIZE	APPLICATIONS	REPLACES		
									GUNITE	MERITOR	WEBB
TWD 600004HD	16.5" X 7.00"	10.41	7.64	8.78	285.75	10	0.96	Truck/Trailer	3401, 3600A, 3600AX, 3576	53123537002	66864B, 66884B, 78502B
TWD 600013HD	16.5" X 8.00"	10.91	8.55	8.78	285.75	10	0.96	Truck/Trailer	3782X, 3891	85123520002	66800B, 66808B, 78501B, 78504B
TWD 600014HD	16.5" X 8.62"	11.34	9.1	8.78	285.75	10	0.96	Truck/Trailer	3807X, 3811	85123570002	66809B, 66854B, 78500B, 78505B
TWD 87101B	16.50" X 7.00"	10.41	7.64	8.53	11.25	10	0.81	Freightliner Tag Axles	3166	53-123564-002	66893
TWD 88797B	16.50" X 7.00"	10.41	7.64	9.00	275	8	0.92	Truck Rear Axles Trailer Axles	3141B	53-123566-002	66875 68797B
TWD 89996B	16.50" X 7.00"	10.41	7.64	8.78	285.75	10	0.96	Truck Rear Axles	3600A	53-123537-002	69996B

*B Means Machine To Balanced

⚠ WARNING: California Proposition 65 - Cancer and Reproductive Harm - www.P65Warnings.ca.gov.



BRAKE DRUMS (continued)

WEBB TWD 56864B

Your brakes will work better and last longer with the cooler Webb **TWD 56864B** brake drum



- Patented Webb CRT™ vents (Cool Running Technology) increase air-flow for superior heat transfer efficiency and cooler wheel-end operating temperatures
- Innovative design manages heat 10% better than similar weight brake drums
- Cooler temperatures mean your brake drums last 10% longer for lower maintenance cost
- Designed for standard-duty drive and trailer applications
- Backed by a nationwide warranty and the best product support in the business
- Designed, cast, and machined in the USA 
- 10 Cast Holes
- 11.25" B.C.
- 8.78" Pilot
- 16.5 x 7 Brakes
- Weight: 104 lbs
- Rating: 23,000 lbs GAWR



Trailer side skirts deflect airflow around wheel-ends causing higher brake temperatures

Trailer skirts improve aerodynamics, however over-the-road data acquired by Webb Engineering revealed they also reduce crosswind and straight line airflow below the trailer. This reduction in air flow resulted in a measured 41% increase in brake temperature. This added heat is torture for your brake system causing reduced braking performance and accelerated brake drum and lining wear.

Webb TWD 56864B is the solution!

Finite Element Analysis and "real world" data acquisition enabled Webb Engineers to optimize the TWD **56864B** brake drum to run cooler in 23K truck and trailer applications. The advanced design includes Webb CRT vents to maximize airflow into the wheel-end allowing the drum to manage heat 10% better than similar weight products.

⚠ WARNING: California Proposition 65 - Cancer and Reproductive Harm - www.P65Warnings.ca.gov.



BRAKE DRUMS (continued)

BRAKE DRUM OPTIONS

BRAKE DRUM TYPES



BRAKE DRUM CODES

The following codes indicate options that are available on our brake drums. The standard code on our brake drums is "F". When ordering, change the "F" code to any of the codes when the option shown is required.

NOTE: Some brake drums are furnished "Balanced Only" as standard ("F" code is not available), in the case of truck and some trailer brake drums. These brake drums are already coded "B" in the catalog. When ordering, change the "B" code to any of these codes where balancing is included as a part of the option when the option shown is required.

CODES:

B=Balanced

C=Special Drilling+Balanced

Special Drilling covers the drilling and tapping of holes for Anti-Skid, Speedometers, Noise Dampeners etc. that are not drilled and tapped as standard.

D=Undersize+Balanced

F=Standard Finished

H=Special Hardness

J=Special Hardness+Balanced

U=Undersized

Z=Oversize+Balanced

Installation, Service and Safety Instructions are available at no cost by contacting our Sales Department at:
 WEBB WHEEL PRODUCTS, INC.
 Website: www.webbwheel.com

Do not attempt to install or repair hubs, wheels, brake drums or rotors unless you have read and understand the instructions.



BRAKE DRUMS (continued)

BRAKE DRUM NUMERICAL SECTION

Drum Number	Weight	Type	Mount	Backface Thickness	Brake Surface Diameter	Overall Depth	Brake Surface Flat	Pilot Diameter	Bolt Circle Diameter	Bolt Holes		Special Information
										No.	Size	
TWD 56864B	104	K	O	0.50	16.50	10.52	7.54	8.78	11.25	10	1.08	
TWD 60876B	107	K	O	0.56	16.50	10.75	7.50	9.44	11.25	10	0.81	
TWD 60876F	108	K	O	0.56	16.50	10.75	7.50	9.44	11.25	10	0.81	*See footer
TWD 61510B	91	K	O	0.50	15.00	9.75	7.52	8.78	11.25	10	1.00	
TWD 61511F	73	K	O	0.50	15.00	8.02	4.32	9.00	11.25	10	1.31	
TWD 61526F**	69	K	I	0.44	15.00	7.00	5.36	9.37	11.25	10	0.81	
TWD 61527B	70	K	O	0.50	15.00	8.86	4.78	8.78	11.25	10	1.00	*See footer
TWD 61528B	70	K	O	0.50	15.00	8.86	4.78	8.78	11.25	10	1.31	*See footer
TWD 61529B	70	H	O	0.50	15.00	8.86	4.78	8.75	11.25	10	1.31	
TWD 61529F	70	H	O	0.50	15.00	8.86	4.78	8.75	11.25	10	1.31	
TWD 61536F	80	K	I	0.50	15.00	8.54	6.41	6.25	8.75	6	0.84	
TWD 61548F	93	H	I	0.50	15.00	9.44	7.50	9.75	11.25	5	0.66	
TWD 61554F	67	G	I	0.50	15.00	7.56	5.50	9.50	11.25	10	0.81	
TWD 61566F	70	A	I	0.50	15.00	7.06	6.38	9.44	11.00	5/6	0.66	
TWD 61567B	97	K	O	0.50	15.00	10.41	7.57	8.78	11.25	10	1.00	
TWD 61567F	97	K	O	0.50	15.00	10.41	7.57	8.78	11.25	10	1.00	
TWD 61571F	106	K	O	0.50	15.00	10.59	7.75	8.53	11.25	10	0.81	
TWD 61574F	98	K	O	0.50	15.00	10.09	7.25	8.53	11.25	10	0.81	
TWD 61576B	105	K	O	0.50	15.00	10.59	7.75	9.00	10.83	8	1.00	
TWD 61576F	105	K	O	0.50	15.00	10.59	7.75	9.00	10.83	8	1.00	
TWD 61577B	104	K	O	0.50	15.00	10.59	7.75	8.78	11.25	10	1.00	
TWD 61577F	104	K	O	0.50	15.00	10.59	7.75	8.78	11.25	10	1.00	
TWD 61586F	101	K	O	0.44	15.00	10.93	7.50	6.44	8.75	6	0.81	
TWD 61591F	102	K	O	0.50	15.00	10.38	7.56	8.53	11.25	10	0.81	For Girling Brakes
TWD 61595F**	88	G	I	0.50	15.00	8.12	7.32	9.50	11.25	5/6	0.78	
TWD 61599F**	87	G	I	0.50	15.00	8.38	7.19	11.00	12.50	5/6	0.66	
TWD 61600B**	86	G	I	0.50	15.00	8.38	7.19	11.25	12.75	5/6	0.78	
TWD 61601F	82	A	I	0.50	15.00	7.38	6.50	11.25	12.75	5/6	0.66	
TWD 61606F**	88	G	I	0.50	15.00	8.62	7.44	11.00	12.50	5/6	0.66	
TWD 61612F**	84	G	I	0.50	15.00	8.16	6.97	11.00	12.50	5/6	0.66	
TWD 61725F	OBSOLETE - Use 61730F											
TWD 61727F**	111	H	I	0.50	16.50	8.75	7.50	11.00	12.50	5/6	0.66	
TWD 61729F	OBSOLETE - Use 62240F											
TWD 61730F	98	H	I	0.50	16.50	8.78	7.41	11.25	12.75	5	0.78	
										6	0.66	
TWD 66864B	108	K	O	0.48	16.50	10.52	7.54	8.78	11.25	10	1.00	
TWD X60611	112	K	O	0.50	16.50	10.62	7.62	8.53	11.25	10	.81	
TWD X61223B	69	H	O	0.50	15.00	8.86	4.78	8.78	11.25	10	1.31	
TWD X61225B	67	H	O	0.50	15.00	9.04	4.50	8.78	11.25	10	1.31	
TWD X61233	113	K	O	0.50	16.50	11.18	7.44	8.78	11.25	10	1.00	
TWD X61363	117	K	O	0.56	16.50	11.46	9.08	8.78	11.25	10	1.09	

Mount: I=Inboard, O=Outboard

*Available for purchase through the pallet program.

**Will become obsolete when current inventory is depleted. Call for availability - if purchased, parts are non-returnable.

⚠ WARNING: California Proposition 65 - Cancer and Reproductive Harm - www.P65Warnings.ca.gov.



BRAKE DRUMS (continued)

BRAKE DRUM DATA SHEET

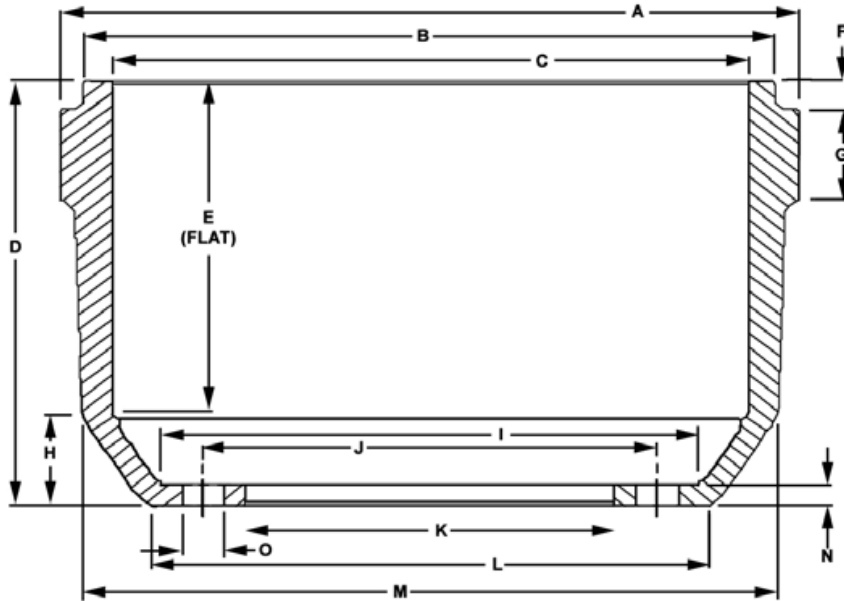

- A. Overall Diameter of Drum
- B. Dust Shield Recess Diameter, If Applicable
- C. Brake Surface Diameter
- D. Overall Depth
- E. Brake Surface Flat
- F. Depth of Dust Shield Recess
- G. Squeeler Band Thickness
- H. Distance from Outside of Backface to Start of Taper
- I. Inside Finished Diameter
- J. Bolt Circle Diameter
- K. Pilot Diameter
- L. Outside Finished Diameter
- M. Diameter at Taper
- N. Backplate Thickness
- O. Bolt Holes: Number and Size



INTRODUCING!

	PART NO.	DESCRIPTION
	TWD 16571B	<ul style="list-style-type: none"> • 10 CAST HOLES • 11.25" B.C. • 8.78" PILOT DIAMETER • 16.5' X 7" BRAKES (NOT INCLUDED) • WEIGHT 104LBS. • RATING: 23,000LBS. GAWR • MACHINE BALANCED • IDEAL FOR OTR FREIGHT HAULING • FULL FMVSS 121 COMPLIANCE • DESIGNED FOR TRACTOR AND TRAILER APPLICATIONS (NORMAL DUTY) • COMPATIBLE WITH POPULAR WHEEL END CONFIGURATIONS/AXLE RATINGS

⚠ WARNING: California Proposition 65 - Cancer and Reproductive Harm - www.P65Warnings.ca.gov.



BRAKE DRUMS (continued)



PART NO.	DESCRIPTION	SIZE	BALANCED	REPLACES				
				CONMET	GUNITE	HD PLUS	MERITOR	WEBB
TWD 3600A	BRAKE DRUM	16.5 X 7"		10009830	-	X60794	03123207002	66864F
TWD 3600AX	BRAKE DRUM	16.5 X 7"	✓	10009830	-	X60794	13123207002	66864B
TWD 3687X	BRAKE DRUM	16.5 X 6"	✓	10033071	-	X61221B	13123399002	65152B
TWD 3710X	BRAKE DRUM	16.5 X 5"	✓	10020147	-	X61222B	13123400002	65710B
TWD 3721AX	BRAKE DRUM	15 X 4"	✓	10001783	G1201X	X61223B	13123254002, 13123366002	61528B
TWD 3753X	BRAKE DRUM	15 X 6"	✓	10020149	-	-	13123465002	61950B, 65710B
TWD 3757	BRAKE DRUM	16.5 X 7"		-	-	-	-	66353F
TWD 3757X	BRAKE DRUM	16.5 X 7"	✓	-	-	-	-	66353B
TWD 3758X	BRAKE DRUM	16.5 X 5"	✓	10014756	3598X	-	13123383002	65151B, 65161B
TWD 3782X	BRAKE DRUM	16.5 X 8"	✓	107637	-	-	13123520002	66800B, 66808B, 77808BW
TWD 3800X	BRAKE DRUM	15 X 4"	✓	10009920	-	X61225B	13123448002	65554B
TWD 3807A	BRAKE DRUM	16.5 X 8.62"		107638	-	-	03123531002	66855F
TWD 3807AX	BRAKE DRUM	16.5 X 8.62"	✓	10012097	3807X	X61367	1312531002	66855B
TWD 3922X	BRAKE DRUM	16.5 X 7"	✓	107885	-	-	85123788002	56864, 66864
TWD G1201X	VALUE BRAKE DRUM	15 X 4"	✓	10001783	3721AX	X61223B	13123254002, 13123366002	61521B
TWD G1213X	VALUE BRAKE DRUM	15 X 4"	✓	10012097	3800X	X61225B	13123448002	65554B
TWD X60794	BRAKE DRUM	16.5 X 7"	✓	107885	-	-	85123788002	56864, 66864

⚠ WARNING: California Proposition 65 - Cancer and Reproductive Harm - www.P65Warnings.ca.gov.



SPOKE WHEELS



PART NO.	WHEEL		OUTER BEARINGS		INNER BEARINGS		SPACING	APPLICATIONS
	SPOKE	SIZE	CUP	CONE	CUP	CONE		
TWD FX196KX*	6	20	552A	555S	6420	6461A	3.02	—
TWD RX226K*	6	20	572	580	592A	594A	4.31	TRUCK REAR AXLE
TWD TX228K*	5	20	HM212011	HM212049	HM218210	HM218248	3.34	TRAILER AXLE
TWD TX229K*	6	20	HM212011	HM212049	HM218210	HM218248	3.34	TRAILER AXLE
TWD TX230K*	5	20	HM518410	HM518445	HM518410	HM518445	4.50	TRAILER AXLE
TWD TX745K	5	20	HM12011	HM212049	653	663	3,81	TAG & TRAILER AXLE
TWD TY233K	6	22	HM21211	HM212049	HM218210	HM218248	3.34	TRAILER AXLE

⚠ WARNING: California Proposition 65 - Cancer and Reproductive Harm - www.P65Warnings.ca.gov.

HUBS

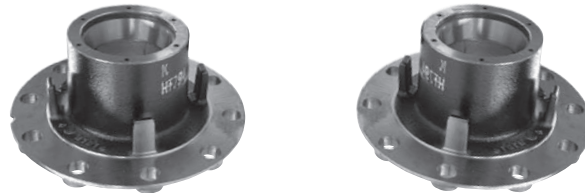

PART NO.	WHEEL	OUTER BEARINGS		INNER BEARINGS		SPACING	APPLICATIONS
	MOUNT	CUP	CONE	CUP	CONE		
TWD H389K	BALL SEAT PILOTED	HM212011	HM212049	HM218210	HM218248	3.34	TRAILER AXLES (GUNITE H389K)
TWD HF805K*	HUB PILOTED	552A	555S	6420	6461A	3.02	—
TWD HR935K*	HUB PILOTED	572	580	592A	594A	4.31	TRUCK REAR AXLE
TWD HT794RD	OUTBOARD	HM212011	HM212049	HM218210	HM218248	3.34	—

*ABS Version

⚠ WARNING: California Proposition 65 - Cancer and Reproductive Harm - www.P65Warnings.ca.gov.



ROTORS

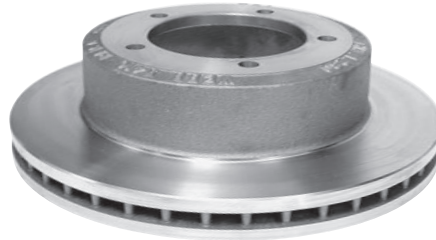

PART NO.	BRAKE SURFACE OUTSIDE DIA.	WIDTH	OVERALL DEPTH	PILOT DIA.	BOLT CIRCLE DIA.	BOLT HOLES NO.	SIZE	APPLICATIONS	REPLACES		
									BENDIX	MERITOR	WEBB
TWD D6052	15.39	1.53	3.40	—	7.25	10	0.57	GM FRONT/ REAR AXLES	141272	23122729002	54301
TWD D6054	14.76	1.34	3.81	5.00	6.75	5	0.65	GM FRONT AXLES	141271	23122687002	54102
TWD D6054C	14.76	1.34	3.81	5.00	7.25	6	0.78	FORD FRONT AXLES	141269	23122700002	54103
TWD D6059	15.38	1.53	6.18	9.5	11.25	10	0.81	MULTI APPLICATION	141606	23122693002	-
TWD D6176M	15.00	1.43	3.21	6	7.25	10	0.57	MULTI APPLICATION	E12588019	23123550004	54773P-65
TWD D6178M	15.00	1.43	7.11	10	11.25	10	0.81	MULTI APPLICATION	-	-	-
TWD D6183M	15.00	1.43	4.44	6	7.25	10	0.57	MULTI APPLICATION	141494	123552	54771P-65

⚠ WARNING: California Proposition 65 - Cancer and Reproductive Harm - www.P65Warnings.ca.gov.

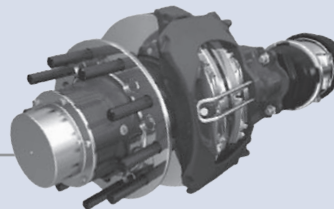

TWD DX195 AIR DISC BRAKE COMPONENTS

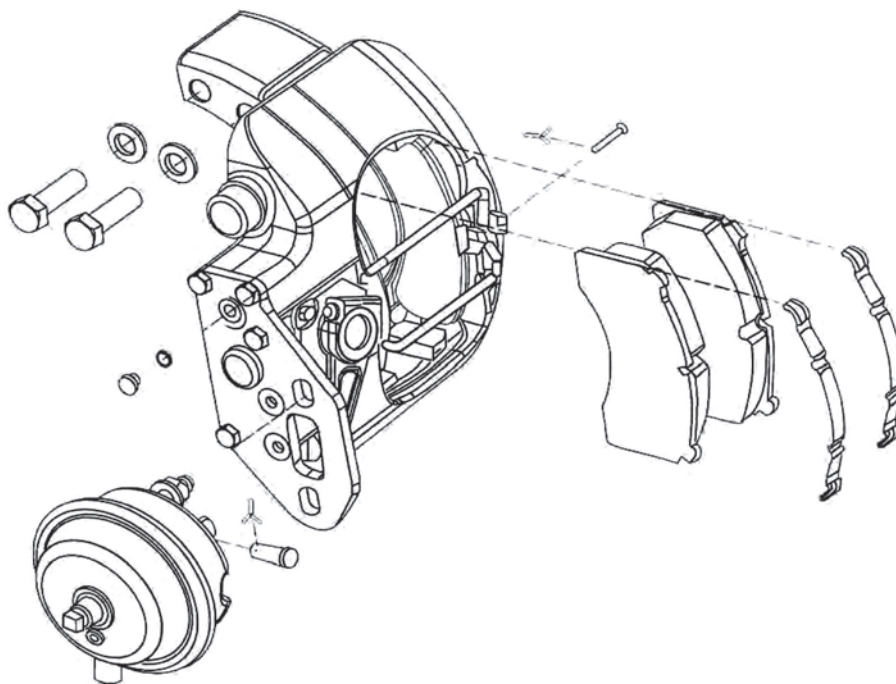

TWD DX19539			
	QTY	PART NO.	DESCRIPTION
	1	TWD DX19539	CALIPER
	1	-	WASHER (NOT SHOWN)
	1	-	BOLT (NOT SHOWN)
TWD DX19540			
	QTY	PART NO.	DESCRIPTION
	1	TWD DX19540	CALIPER
	1	-	WASHER (NOT SHOWN)
	1	-	BOLT (NOT SHOWN)

⚠ WARNING: California Proposition 65 - Cancer and Reproductive Harm - www.P65Warnings.ca.gov.



MERITOR

TWD DX195 AIR DISC BRAKE ASSEMBLY (continued)

TWD MCK1154

	ITEM	QTY	PART NO.	DESCRIPTION
	1	1	NOT SOLD SEPARATELY	PAD RETAINER BAR
	2	1		GASKET
	3	1		CAPSCREW
	4	1		PIN
	5	2		SCREW
	6	1		COTTER PIN
	7	1		NUT
	-	1		LOCTITE (NOT SHOWN)

TWD MCK1161

	ITEM	QTY	PART NO.	DESCRIPTION
	1	1	NOT SOLD SEPARATELY	LEVER
	2	1		CAPSCREW
	3	1		NUT

TWD MCK1171

	ITEM	QTY	PART NO.	DESCRIPTION
	1	2	NOT SOLD SEPARATELY	SLIDE PIN COVER
	2	1		SLIDE PIN SCREW
	3	1		SLIDE PIN SCREW
	4	1		PIN
	5	1		PIN
	6	2		BUSHING
	7	2		SLIDE PIN
	8	1		WASHER
	9	1		FILTER PLUG
	10	1		COTTER PIN
	11	2		SPREADER PLATE SCREW
	12	2		SLIDE PIN BOOT
	13	2		PISTON BOOT
	14	2		BOLT
-	1	LOCTITE (NOT SHOWN)		
-	1	GREASE (NOT SHOWN)		
-	1	LUBRICANT (NOT SHOWN)		

TWD KIT195020, TWD KIT195021, TWD MMD1525AF

	ITEM	QTY	PART NO.	DESCRIPTION
	1	4	NOT SOLD SEPARATELY	DISC PADS
	2	4		SPRINGS
	3	2		COTTER PINS



MERITOR

TWD DX195 CALIPER ASSEMBLY

TWD MCK1189

	QTY	PART NO.	DESCRIPTION
	1	NOT SOLD SEPARATELY	SADDLE
	1		SLIDE PIN SCREW
	1		SLIDE PIN SCREW
	2		SLIDE PIN COVER
	1		LOCTITE
	1		LUBRICANT

TWD MCK1192

	ITEM	QTY	PART NO.	DESCRIPTION
	1	2	NOT SOLD SEPARATELY	SLIDE PIN COVER
	2	1		SLIDE PIN SCREW
	3	1		SLIDE PIN SCREW
	4	2		SLIDE PIN BOOT
	5	2		PISTON BOOT
	-	1		LOCTITE (NOT SHOWN)
	-	1		LUBRICANT (NOT SHOWN)

TWD MCK1294

	ITEM	QTY	PART NO.	DESCRIPTION
	1	1	NOT SOLD SEPARATELY	ECCENTRIC SHAFT ASSEMBLY
	2	1		COVER PLATE ASSEMBLY
	3	1		GASKET
	4	2		SCREW
	5	1		CAPSCREW
	6	1		NUT
	7	1		WASHER
	8	1		FILLER PLUG
	9	1		PIN
	10	1		COTTER PIN
	11	1		WASHER
	12	1		DUST SEAL
	-	1		GREASE NIPPLE (NOT SHOWN)
	-	1		LOCTITE (NOT SHOWN)
-	1	GREASE (NOT SHOWN)		

⚠ WARNING: California Proposition 65 - Cancer and Reproductive Harm - www.P65Warnings.ca.gov.



TWD DX225 AIR DISC BRAKE ASSEMBLY

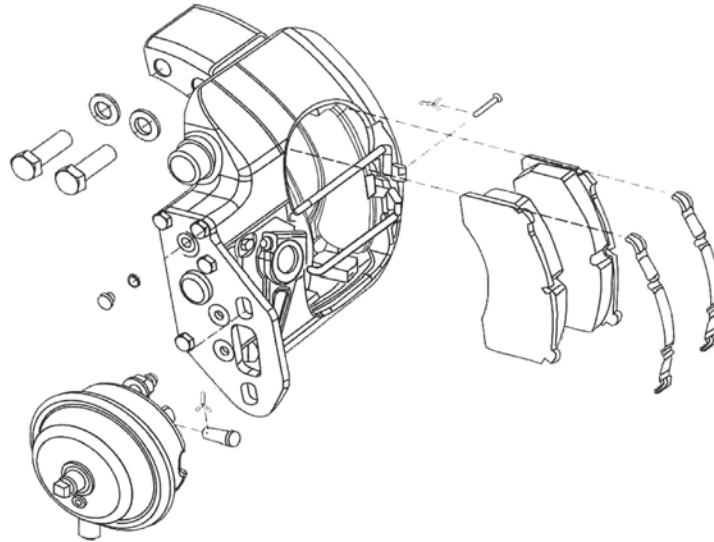

TWD DX225211001K

	ITEM	QTY	PART NO.	DESCRIPTION
	1	1	TWD DX225211001K	CALIPER
	2	1	NOT SOLD SEPARATELY	WASHER
	3	1	NOT SOLD SEPARATELY	BOLT

TWD DX225211002K

	ITEM	QTY	PART NO.	DESCRIPTION
	1	1	TWD DX225211002K	CALIPER
	2	1	NOT SOLD SEPARATELY	WASHER
	3	1	NOT SOLD SEPARATELY	BOLT

TWD KIT195013

	ITEM	QTY	PART NO.	DESCRIPTION
	1	1	TWD 43-X-1194	CLEVIS PIN
	2	1	TWD K-234Z	COTTER PIN

TWD MCK1375

	ITEM	QTY	PART NO.	DESCRIPTION
	1	1	NOT SOLD SEPARATELY	PLUG
	2	1	NOT SOLD SEPARATELY	WASHER

⚠ WARNING: California Proposition 65 - Cancer and Reproductive Harm - www.P65Warnings.ca.gov.



MERITOR

TWD DX225 AIR DISC BRAKE ASSEMBLY (continued)

TWD KIT195011

	ITEM	QTY	PART NO.	DESCRIPTION
	1	4	NOT SOLD SEPARATELY	SADDLE BOLT
	2	4	NOT SOLD SEPARATELY	WASHER

TWD MCK1161

	ITEM	QTY	PART NO.	DESCRIPTION
	1	1	NOT SOLD SEPARATELY	LEVER
	2	1		CAPSCREW
	3	1		NUT

TWD MCK1159

	ITEM	QTY	PART NO.	DESCRIPTION
	1	1	NOT SOLD SEPARATELY	PAD RETAINER BAR
	2	1		GASKET
	3	3		SHAFT COVER SCREW
	4	1		WASHER
	5	1		CAPSCREW
	6	1		NUT
	-	1		LOCTITE (NOT SHOWN)

TWD MCK1294

	ITEM	QTY	PART NO.	DESCRIPTION
	1	1	NOT SOLD SEPARATELY	ECCENTRIC SHAFT ASSEMBLY
	2	1		COVER PLATE ASSEMBLY
	3	1		GASKET
	4	2		SCREW
	5	1		CAPSCREW
	6	1		NUT
	7	1		WASHER
	8	1		FILLER PLUG
	9	11		PIN
	10	1		COTTER PIN
	11	1		WASHER
	12	1		DUST SEAL
-	1	GREASE NIPPLE (NOT SHOWN)		
-	1	LOCTITE (NOT SHOWN)		
-	1	GREASE (NOTH SHOWN)		

⚠ WARNING: California Proposition 65 - Cancer and Reproductive Harm - www.P65Warnings.ca.gov.



MERITOR

TWD DX225 AIR DISC BRAKE ASSEMBLY (continued)

TWD MCK1173

	ITEM	QTY	PART NO.	DESCRIPTION
	1	2	NOT SOLD SEPARATELY	SLIDE PIN COVER
	2	1		SLIDE PIN SCREW
	3	1		SLIDE PIN SCREW
	4	1		PIN
	5	1		PIN
	6	2		BUSHING
	7	2		SLIDE PIN
	8	1		WASHER
	9	1		FILLER PLUG
	10	1		SCREW
	11	1		WASHER
	12	2		SLIDE PIN BOOT
	13	2		PISTON BOOT
	14	2		SCREW
	15	2		PIN
-	1	LOCTITE (NOT SHOWN)		
-	1	LUBRICANT (NOT SHOWN)		

TWD MCK1196

	QTY	PART NO.	DESCRIPTION
	1	NOT SOLD SEPARATELY	CARRIER
	1		SLIDE PIN SCREW
	1		SLIDE PIN SCREW
	3		SLIDE PIN COVER
	1		LOCTITE
	1		LUBRICANT

TWD MCK1192

	ITEM	QTY	PART NO.	DESCRIPTION
	1	2	NOT SOLD SEPARATELY	SLIDE PIN COVER
	2	1		SLIDE PIN SCREW
	3	1		SLIDE PIN SCREW
	4	2		SLIDE PIN BOOT
	5	2		PISTON BOOT
	6	1		LOCTITE (NOT SHOWN)
	7	1		LUBRICANT (NOT SHOWN)

TWD KIT225020, TWD KIT225021

	QTY	PART NO.	DESCRIPTION
	4	NOT SOLD SEPARATELY	DISC PADS
	4		SPRINGS
	2		COTTER PINS

⚠ WARNING: California Proposition 65 - Cancer and Reproductive Harm - www.P65Warnings.ca.gov.





B

WHEELS & WHEEL END COMPONENTS

ALUMINUM & STEEL WHEELS	70
STEEL WHEELS	71
TIRE VALVES & ACCESSORIES	72
SERVICE TOOLS & GAUGES	73
HARDWARE	74-77
WHEEL SAFETY PRODUCTS	78
AXLE COMPONENTS	79-85



ACCU-LITE - THE NEW STANDARD

Semi-Polished Aluminum
 Hub Piloted, Dual-Mounting, Two-Piece Flange Nut
 10 Bolt Holes, Bolt Circle 285.75 mm, Bore 220 mm



PART NO.	WHEEL SIZE	FINISH	OFFSET (INCHES)	VALVE	APPROX. WEIGHT (LBS)	MAX. LOAD & INFL. (LBS-PSI)
TWD 41362SP	24.5 X 8.25	ENHANCED FINISH	6.59	TR545D	54	7400 - 130

⚠ WARNING: California Proposition 65 - Cancer and Reproductive Harm - www.P65Warnings.ca.gov.

15° TUBELESS STEEL WHEELS

HUB-PILOTED DUAL-MOUNTING TWO-PIECE FLANGE NUT - 8 BOLT HOLES

Bolt Circle 275 mm, Bore 221 mm



PART NO.	WHEEL SIZE	FINISH	OFFSET (IN.)	HAND HOLES	RECOMMENDED VALVE	APPROX. WEIGHT (LBS)	MAX. LOAD & INFL. (LBS-PSI)
TWD 50180PKWHT21	19.5 X 6.75 RW ²	E-COAT WHITE	5.60	4	TR575	61	5000 - 120

STUD-PILOTED DUAL-MOUNTING DOUBLE CAP NUT - EXTRA SERVICE WHEELS

10 Hole, 11.25" Bolt Circle, 8.72" Bore

PART NO.	WHEEL SIZE	FINISH	OFFSET (IN.)	HAND HOLES	RECOMMENDED VALVE	APPROX. WEIGHT (LBS)	MAX. LOAD & INFL. (LBS-PSI)
TWD 27404PKWHT21	22.5 X 8.25	E-COAT WHITE	6.62	2	TR572	78	7400 - 120

* For inner duals use TR574 with F29 bend and a 2" extension

¹HC Denotes heavy construction to differentiate from light rim trucks

²RW Denotes revised well for increased brake clearance

⚠ WARNING: California Proposition 65 - Cancer and Reproductive Harm - www.P65Warnings.ca.gov.



15° TUBELESS STEEL WHEELS (continued)
HUB-PILOTED DUAL-MOUNTING TWO-PIECE FLANGE NUT - 10 BOLT HOLES

Bolt Circle 285.75 mm, Bore 220 mm

PART NO.	WHEEL SIZE	FINISH	OFFSET (IN.)	HAND HOLES	RECOMMENDED VALVE	APPROX. WEIGHT (LBS)	MAX. LOAD & INFL. (LBS-PSI)
ACCU-LITE™							
TWD 50408PKGRY21	22.5 X 8.25	E-COAT GRAY	6.60	2	TR572-F19	70	7400 - 120
TWD 50408PKWHT21	22.5 X 8.25	E-COAT WHITE	6.60	2	TR572-F19	70	7400 - 120
TWD 50487PKWHT21	22.5 X 8.25	E-COAT WHITE	6.60	5	TR572-F19	68	7400 - 120
EXTRA SERVICE WHEELS™							
TWD 29195PKWHT21	19.5 X 7.5 RW ²	E-COAT WHITE	6.4	5	TR546	65	6700 - 120
TWD 50409PKWHT21	24.5 X 8.25	E-COAT WHITE	6.62	2	TR573	86	7400 - 120
EXTRA SERVICE WHEELS™ - HEAVY LOAD APPLICATIONS							
TWD 28828PKWHT21	22.5 X 8.25	E-COAT WHITE	6.62	2	TR573	83	8000 - 120
TWD 29039PKWHT21	22.5 X 9	E-COAT WHITE	5.25	5	TR573	103	10000 - 130
TWD 29300PKWHT21	22.5 X 9.00	E-COAT WHITE	6.62	5	TR573	108	9000 - 130

* For inner duals use TR574 with F29 bend and a 2" extension
¹HC Denotes heavy construction to differentiate from light rim trucks
²RW Denotes revised well for increased brake clearance

⚠ WARNING: California Proposition 65 - Cancer and Reproductive Harm - www.P65Warnings.ca.gov.



15° TUBELESS STEEL WHEELS (continued)
HUB-PILOTED DUAL-MOUNTING TWO-PIECE FLANGE NUT - 10 BOLT HOLES

Bolt Circle 285.75 mm, Bore 220 mm







PART NO.	WHEEL SIZE	FINISH	OFFSET (IN.)	HAND HOLES	RECOMMENDED VALVE	APPROX. WEIGHT (LBS)	MAX. LOAD & INFL. (LBS-PSI)
TWD HDW28408EL	22.5 X 8.25	WHITE POWDER COAT	6.62	2	TR573	86	7400 - 120
TWD HDW28409EL	24.5 X 8.25	WHITE POWDER COAT	6.62	2	TR573	86	7400 - 120

⚠ WARNING: California Proposition 65 - Cancer and Reproductive Harm - www.P65Warnings.ca.gov.







TIRE VALVES AND ACCESSORIES

	PART NO.	DESCRIPTION
	NTH 90-100-1	VALVE CORE, STANDARD BORE HEAT-RESISTANT CORE FOR CARS, TRUCKS, BUSES (PACK OF 25)
	NTH 90-184-1	METAL DOME VALVE CAP (PACK OF 25)
	NTH 90-275	TRUCK VALVE FOR ALUMINUM WHEELS, 4-3/4" E.L., 90° BEND ANGLE
	NTH 90-279	TRUCK VALVE FOR ALUMINUM WHEELS, 5-1/2" E.L., 90° BEND ANGLE
	NTH 90-259	TRUCK & BUS VALVE - 3-3/4" LENGTH (IMPORTED)
	NTH 90-260	TRUCK & BUS VALVE - 4-3/8" LENGTH (IMPORTED)
	NTH 90-302	TRUCK VALVE EXTENSION, 1" LONG COLLAR, 3-1/16" E.L.
	NTH 90-306	TRUCK VALVE EXTENSION, 1" LONG COLLAR, 5-1/16" E.L.
	NTH 90-305	TRUCK VALVE EXTENSION, 1" LONG COLLAR, 6-1/16" E.L.

⚠ WARNING: California Proposition 65 - Cancer and Reproductive Harm - www.P65Warnings.ca.gov.





TIRE COUPLERS AND NIPPLES

	PART NO.	THREAD	TYPE	END
	NTH 90-612	1/4" NPT	ARO	FEMALE COUPLER
	NTH 90-618	1/4" NPT	ARO	MALE NIPPLE
	NTH 90-670	1/4" NPT	INDUSTRIAL	FEMALE COUPLER
	NTH 90-674	1/4" NPT	INDUSTRIAL	MALE NIPPLE

⚠ WARNING: California Proposition 65 - Cancer and Reproductive Harm - www.P65Warnings.ca.gov.





SERVICE TOOLS

	PART NO.	DESCRIPTION
	NTH 90-5006	DUAL FOOT LOCK-ON AIR CHUCK, 1/4" NPT FEMALE THREAD, 7" LONG DUAL FOOT FOR HARD TO REACH TRACTOR, DUAL WHEEL TRUCKS AND BUS TIRES. FOR STANDARD AIR LINE SERVICE.
	NTH 90-5010	DUAL FOOT LOCK-ON AIR CHUCK, 1/4" NPT FEMALE THREAD, 14" LONG
	NTH 90-5002	LOCK-ON AIR CHUCK, 1/4" NPT FEMALE THREAD, 6" LONG, NEW DESIGN - GREATER DURABILITY & MORE USER FRIENDLY ON THE STRAIGHT-ON AND 30° REVERSE ANGLE CHUCK.
	NTH 90-5261	EUROPEAN STYLE AIR CHUCK, CLIP-ON STYLE (CLOSED) WITH 1/4" FEMALE FITTING

⚠ WARNING: California Proposition 65 - Cancer and Reproductive Harm - www.P65Warnings.ca.gov.

GAUGES

	PART NO.	DESCRIPTION
	NTH 90-376	TIRE TREAD DEPTH GAUGE QUICKLY AND ACCURATELY MEASURES HOW MUCH TREAD IS LEFT ON TIRE. CALIBRATED IN 1/32" UNITS AND MILLIMETERS.
	NTH 90-388	CALIBRATION: 10 - 120 PSI INCREMENTS: 2 PSI BAR: NYLON CHUCK STYLE: STRAIGHT-ON 30° REVERSE FINISH: CHROME

⚠ WARNING: California Proposition 65 - Cancer and Reproductive Harm - www.P65Warnings.ca.gov.



MERITOR

REAR SPOKE WHEEL CLAMPS

	PART NO.	DESCRIPTION				REPLACES				SPACER BAND WIDTH
		A	B	C	D	WEBB	ERIE	DAYTON	NWRA	
	TWD R005571P	1-1/8"	2-7/8"	2-1/2"	3/4"	16123	E1	09-612317	W96	4"

⚠ WARNING: California Proposition 65 - Cancer and Reproductive Harm - www.P65Warnings.ca.gov.



WHEEL-GUARD SEPARATOR PLATES

The Wheel-Guard nylon separator plate is approximately .040" thick. It is placed between the hub or drum and the wheel, and/or between two wheels in dual applications. The Wheel-Guard is recommended in severe applications where corrosion and/or wear have been identified. Both aluminum and steel wheels can benefit from use of the Wheel-Guard. Care must be exercised in centering the separator plate prior to torquing and stud length must be checked as each plate is approximately .040" thick.

	PART NO.	DESCRIPTION
	TWD 5901	10-HOLE, 11-1/4" BOLT CIRCLE, STUD-PILOTED 7/8" AND 1-1/8" DIAMETER STUDS
	TWD 5902	10-HOLE, 11-1/4" BOLT CIRCLE, STUD-PILOTED 3/4" DIAMETER STUDS
	TWD 5903	10-HOLE, 285.75 MM BOLT CIRCLE, HUB-PILOTED 22 MM DIAMETER STUDS
	TWD 7381	10-HOLE, 335 MM BOLT CIRCLE, HUB-PILOTED 22 MM DIAMETER STUDS
	TWD 7902	8-HOLE, 275 MM BOLT CIRCLE, HUB-PILOTED 20 MM DIAMETER STUDS

⚠ WARNING: California Proposition 65 - Cancer and Reproductive Harm - www.P65Warnings.ca.gov.



NUTS

TWO PIECE METRIC FLANGED NUTS

	PART NO.	THREAD	HEX	HT.	REPLACES
	TWD R009020	M22 X 1.5 METRIC	1-19/64" 33 MM	1-1/32" 26 MM	NWRA: X-2159

⚠ WARNING: California Proposition 65 - Cancer and Reproductive Harm - www.P65Warnings.ca.gov.



STUDS

RIM STUDS



SUPPLIER: MIDWEST TRUCKING	PART NO.	DESCRIPTION				REPLACES	
		TH. SIZE	A	B	C	DAYTON	NWRA
	TWD R005706	3/4" - 10	3-1/8"	1-1/16"	1-7/8"	08-204734	B-612
	TWD R005728	3/4" - 10	3-5/8"	1-1/16"	2-3/8"	-	X1730
	TWD R005729	3/4" - 10	4"	1-1/16"	2-3/4"	-	X2106

METRIC SERRATED STUDS

M22 X 1.5 Metric Thread – .975 Stud Body Diameter – Grade 10.9

SUPPLIER: MERITOR	PART NO.	DESCRIPTION				REPLACES	
		A	B	C	D	GUNITE	WEBB
	TWD R006036	3-1/2"	23/32"	2-1/4"	3/8"	-	101164
	TWD R008980	5-3/32"	7/8"	3-3/4"	3/8"	W1160	-
	TWD R008981	4"	7/8"	2-29/32"	3/8"	W1164	-
	TWD R008987	5-3/16"	1-1/16"	3-23/32"	3/8"	W1211	-

METRIC SERRATED HEAD STUDS

M22 X 1.5 Metric Thread – .901 Body Diameter – Grade 10.9

SUPPLIER: MERITOR	PART NO.	DESCRIPTION				REPLACES	
		A	B	C	D	BUDD	NWRA
	TWD R005997	3-21/32"	7/8"	2-29/64"	13/32"	106216	X-2155
	TWD R005999	4-9/16"	7/8"	3-13/32"	13/32"	106397	X-2158

DRIVE AXLE STUD

3/4" – 16 Thread – .975 Stud Body Diameter Application: Aluminum Disc Wheels Grade 8

SUPPLIER: MIDWEST TRUCKING	PART NO.	DESCRIPTION					REPLACES
		A	B	C	D	E	NWRA
	TWD R005983L	3-3/8"	1-3/8"	2-1/4"	1/4"	1"	X-2132
	TWD R005983R						X-2131

WARNING: California Proposition 65 - Cancer and Reproductive Harm - www.P65Warnings.ca.gov.



STUDS (continued)

METRIC SERRATED WHEEL STUD

M22 X 1.5 Thread - .910 Stud Body Diameter - Grade 10.9

SUPPLIER: MIDWEST TRUCKING	PART NO.	DESCRIPTION				REPLACES
		A	B	C	D	GUNITE
	TWD R0010221	5-11/32"	1-9/16"	3-7/16"	1/2"	W702

SERRATED WHEEL STUDS

3/4" - 16 Thread - .784" Body Diameter - Grade 8

SUPPLIER: MIDWEST TRUCKING	PART NO.	DESCRIPTION					REPLACES
		A	B	C	D	E	BUDD
	TWD R004966L	2-5/8"	1-1/4"	1-1/4"	5/16"	1/2"	59264
	TWD R004966R						59263
	TWD R004967L	2-7/8"	1-1/2"	1-1/4"	1/4"	1/2"	61969
	TWD R004967R						61968
	TWD R004968L	2-7/8"	1-1/2"	1-1/4"	1/2"	1/2"	49852
	TWD R004968R						49851

METRIC CLIPPED HEAD STUD

.910 M22 - 1.5 Thread - Grade 10.9" - D Head

SUPPLIER: MERITOR	PART NO.	DESCRIPTION			REPLACES
		A	B	C	CONMET
	TWD R006030	5-1/4"	1-19/64"	3-11/32"	101150

⚠ WARNING: California Proposition 65 - Cancer and Reproductive Harm - www.P65Warnings.ca.gov.



STUDS (continued)

DRIVE FLANGE & GENERAL PURPOSE STUDS

SUPPLIER: MIDWEST TRUCKING	PART NO.	BODY DIA.	A	B (HUB END)		C (NUT END)	
				THREAD	THREAD LENGTH	THREAD	THREAD LENGTH
	TWD R004951	5/8"	2-5/8"	5/8" - 11	15/16"	5/8" - 18	1-1/4"
	TWD R004952	5/8"	3"	5/8" - 11	7/8"	5/8" - 18	1-13/16"
	TWD R004953	5/8"	3-1/2"	5/8" - 11	7/8"	5/8" - 18	2-1/4"

DRIVE FLANGE STUDS (DAYTON, GUNITE & MERITOR)

SUPPLIER: MIDWEST TRUCKING	PART NO.	BODY DIA.	A	B (HUB END)		C (NUT END)		REPLACES
				THREAD	THREAD LENGTH	THREAD	THREAD LENGTH	
	TWD R005872	5/8"	3-11/16"	5/8" - 11	1-17/32"	5/8" - 18	1-1/8"	MERITOR: 4X-1027
	TWD R005955	3/4"	3-1/4"	3/4" - 10	1-1/8"	3/4" - 16	1-1/4"	DAYTON: 08-007471 NAVISTAR: 611428

⚠ WARNING: California Proposition 65 - Cancer and Reproductive Harm - www.P65Warnings.ca.gov.

DRIVE FLANGE WEDGES

SUPPLIER: MIDWEST TRUCKING	PART NO.	A	B	C	REPLACES
	TWD R005740	1/2"	13/16"	13/32"	1246-T-306
	TWD R005743	5/8"	1"	15/32"	1246-Y-233
	TWD R005960	5/8"	1"	9/16"	1246-D-290

⚠ WARNING: California Proposition 65 - Cancer and Reproductive Harm - www.P65Warnings.ca.gov.

WHEEL-CHECK™

THE LOOSE WHEEL-NUT INDICATOR

WHEEL CHECK SAFETY PRODUCTS

WHEEL-CHECK™, a simple and effective product that lets the user know with absolute certainty when a wheel nut has moved. By performing a quick visual inspection of the wheels, the inspector has no trouble in spotting the nuts that have moved.

If so, simply remove the WHEEL-CHECK™ indicator and replace it with a red WHEEL-TORQUE™ identifier. This will help your re-torque service provider identify and torque only those wheel nuts that need to be re-torqued.

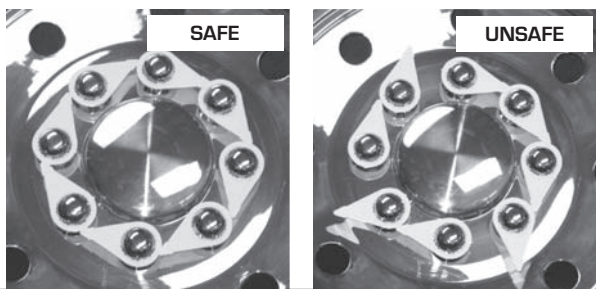

WHEEL-CHECK PART NO. GREEN HIGH VISIBILITY	WHEEL-CHECK PART NO. ORANGE HIGH TEMPERATURE	WHEEL-TORQUE PART NO. RED	NUT SIZES (INCHES)	NUT SIZES (MM)
—	—	TWD WLTO-AA	1-1/2	38.1
—	TWD WCHT-A	TWD WLTO-A	1-1/2	37.5
TWD WLCH-B	TWD WCHT-B	TWD WLTO-B	1-5/16	33.0
TWD WLCH-C	—	TWD WLTO-C	7/8	22.0
TWD WLCH-D	—	TWD WLTO-D	1-1/16	27.0
—	—	TWD WLTO-E	13/16	20.5
TWD WLCH-F	TWD WCHT-F	TWD WLTO-F	1-1/4	31
TWD WLCH-G	—	TWD WLTO-G	1	25.0
TWD WLCH-H	—	TWD WLTO-H	1-9/16	40.5
—	—	TWD WLTO-I	27/32	20.8
TWD WLCH-J	—	TWD WLTO-J	1-3/4	44.0
TWD WLCH-K	—	TWD WLTO-K	1-3/16	30.0
TWD WLCH-L	—	TWD WLTO-L	1-8/32	32.0
TWD WLCH-M	—	TWD WLTO-M	15/16	23.8
TWD WLCH-N	—	TWD WLTO-N	1-1/8	28.0
—	—	TWD WLTO-O	3/4	19.0
TWD WLCH-P	—	TWD WLTO-P	1-3/8	35.0

⚠ WARNING: California Proposition 65 - Cancer and Reproductive Harm - www.P65Warnings.ca.gov.



HUB CAPS

CAST ALUMINUM HUB CAPS W/ LARGE RED FILL PLUG & NO SIDE FILL PLUG

	PART NO.	DESCRIPTION	BOLT CIRCLE	BOLT SIZE	NUMBER OF BOLTS
	TWD 3004009	BULK - 25 PACK	5-1/2	5/16	6
	TWD 3404009	STANDARD	5-1/2	5/16	6

CAST ALUMINUM HUB CAPS W/ LARGE RED FILL PLUG & SIDE FILL PLUG

	PART NO.	DESCRIPTION	BOLT CIRCLE	BOLT SIZE	NUMBER OF BOLTS
	TWD 3034009	BULK - 25 PACK	5-1/2	5/16	6
	TWD 3434009	STANDARD	5-1/2	5/16	6

STANDARD HUB CAPS W/ SIDE FILL

	PART NO.	BOLT CIRCLE	BOLT SIZE	NUMBER OF BOLTS
	TWD 3434024	4-1/2	5/16	6
	TWD 3434195	6-3/4	5/16	6
	TWD 3434249	5-1/2	5/16	6

⚠ WARNING: California Proposition 65 - Cancer and Reproductive Harm - www.P65Warnings.ca.gov.

HUB CAP PLUG

	PART NO.	DESCRIPTION
	TWD 3595990	1-1/8" RED HUB CAP VENT PLUG

⚠ WARNING: California Proposition 65 - Cancer and Reproductive Harm - www.P65Warnings.ca.gov.

HUB CAP GASKET

	PART NO.	DESCRIPTION
	TWD 3303009	GASKET FOR 6 HOLE HUB CAP

⚠ WARNING: California Proposition 65 - Cancer and Reproductive Harm - www.P65Warnings.ca.gov.

TIMKEN

GREASE SEAL

	PART NO.	DESCRIPTION
	TWD WB116GST	WHEEL BOSS GREASE SEAL

⚠ WARNING: California Proposition 65 - Cancer and Reproductive Harm - www.P65Warnings.ca.gov.

HUB CAP

	PART NO.	DESCRIPTION
	TWD WB117HC	ALUMINUM HUB CAP FOR WHEEL BOSS SEAL

⚠ WARNING: California Proposition 65 - Cancer and Reproductive Harm - www.P65Warnings.ca.gov.



SCOTSEAL

	PART NO.	APPLICATION
	NOS 27438	FRONT AXLE
	NOS 28758	FRONT AXLE
	NOS 35066	FRONT AXLE
	NOS 38780	DRIVE AXLE
	NOS 40136	TRAILER AXLE
	NOS 42623	TRAILER AXLE (PRO-PAR)
	NOS 42672	DRIVE AXLE
	NOS 43764	FRONT AXLE
	NOS 46305	TRAILER AXLE
	NOS 47697	DRIVE AXLE

PLUS XL

	PART NO.	APPLICATION
	NOS 38776	DRIVE AXLE
	NOS 35058	FRONT AXLE
	NOS 40129	TRAILER AXLE
	NOS 42627	TRAILER AXLE (PRO-PAR)
	NOS 42673	DRIVE AXLE
	NOS 43761	FRONT AXLE
	NOS 46300	TRAILER AXLE
	NOS 47691	REPLACE 47692 NARROW ABS VERSION



HUB SEALS

GUARDIAN HP HUB SEALS

	PART NO.	APPLICATION
	TWD 3070723	PRO-PAR TRAILER AXLE, FRUEHAUF, EATON P-22, MERITOR TP, DANA
	TWD 3070743	25,500# TRAILER AXLE, MERITOR, STANDARD FORGE, DANA, EATON
	TWD 3090973	38,000#, 46,000# TANDEM AXLES, EATON, FORD, FREIGHTLINER, KENWORTH, WESTERN STAR, PETERBILT, MERITOR, NAVISTAR, VOLVO GM

GRIT GUARD TWO-PIECE HUB SEALS

	PART NO.	APPLICATION
	TWD 3727097	22,500# TRAILER AXLE, DANA, EATON, MERITOR, STANDARD FORGE
	TWD 3727098	19,000# TRAILER AXLE, DANA, EATON, MERITOR, STANDARD FORGE
	TWD 3727099	PRO-PAR TRAILER AXLE, DANA, EATON P-22, FRUEHAUF, MERITOR TP
	TWD 3828036	12,000# FRONT AXLE, MERITOR EATON, FORD, FREIGHTLINER, KENWORTH, WESTERN STAR, NAVISTAR, PETERBILT, VOLVO GM
	TWD 3828064	16,000# FRONT AXLE, FORD, NAVISTAR, MACK, MERITOR, WHITE, KENWORTH, WESTERN STAR, PETERBILT, VOLVO GM
	TWD 3929099	34,000# DRIVE AXLE, EATON, FORD, NAVISTAR, WHITE
	TWD 3929112	44,000# DRIVE AXLE, MACK
	TWD 3929131 *	38,000#, 46,000# TANDEM AXLES, EATON, FORD, FREIGHTLINER, KENWORTH, WESTERN STAR, PETERBILT, MERITOR, NAVISTAR, VOLVO GM

VOYAGER HUB-INSTALLED UNITIZED SEALS

	PART NO.	APPLICATION
	TWD 3830136	12,000# FRONT AXLE, MERITOR, EATON, FORD, FREIGHTLINER, KENWORTH, WESTERN STAR, NAVISTAR, PETERBILT, VOLVO GM
	TWD 3830164	16,000# FRONT AXLE, FORD, NAVISTAR, MACK, MERITOR, WHITE, KENWORTH, WESTERN STAR, PETERBILT, VOLVO GM
	TWD 3930173	38,000#, 46,000# TANDEM AXLES, EATON, FORD, FREIGHTLINER, KENWORTH, WESTERN STAR, PETERBILT, MERITOR, NAVISTAR, VOLVO GM

*Use with Wabco ABS

⚠ WARNING: California Proposition 65 - Cancer and Reproductive Harm - www.P65Warnings.ca.gov.

TIMKEN

BEARING CUPS

	PART NO.	DESCRIPTION
	TWD 552-A	BEARING CUP
	TWD 592-A	

⚠ WARNING: California Proposition 65 - Cancer and Reproductive Harm - www.P65Warnings.ca.gov.

BEARINGS

	PART NO.	DESCRIPTION
	TWD 598-A	

⚠ WARNING: California Proposition 65 - Cancer and Reproductive Harm - www.P65Warnings.ca.gov.

CUP & CONE BEARING SETS

	PART NO.	CUP	CONE
	TWD SET401	TWD BR572	TWD BR580
	TWD SET403	TWD 592-A	TWD 594-A
	TWD SET405	TWD BR653	TWD BR663
	TWD SET406	—	TWD BR3782
	TWD SET413	TWD HM212011	TWD HM212049
	TWD SET414	TWD HM218210	TWD HM218248
	TWD SET415	TWD HM518410	TWD HM518445
	TWD SET423	TWD BR6420	TWD 6461-A
	TWD SET424	TWD 552-A	TWD 555-S

⚠ WARNING: California Proposition 65 - Cancer and Reproductive Harm - www.P65Warnings.ca.gov.

HUB REBUILD KITS



TWD FFTC1 - FF STEER KIT			
KIT CONTENTS	MILEMATE PART NO.	COMPONENT PART NO.	QTY
INNER NP CONE	TWD SET427	TWD NP899357	1
INNER NP CUP	TWD SET427	TWD NP026773	1
OUTER NP CONE	TWD SET428	TWD NP874005	1
OUTER NP CUP	TWD SET428	TWD NP435398	1
SPACER	-	-	1
TWD RDTC1 - R DRIVE KIT			
KIT CONTENTS	MILEMATE PART NO.	COMPONENT PART NO.	QTY
INNER NP CONE	TWD SET429	TWD NP034946	1
INNER NP CUP	TWD SET429	TWD NP363298	1
OUTER NP CONE	TWD SET430	-	1
OUTER NP CUP	TWD SET430	TWD NP053874	1
SPACER	-	-	1

⚠ WARNING: California Proposition 65 - Cancer and Reproductive Harm - www.P65Warnings.ca.gov.

MILEMATE MATCHED WHEEL BEARING SETS



PART NO.	SET INCLUDES	POPULAR MANUFACTURERS
TWD SET401	580, 572	ARVINMERITOR, DANA, IHC, MACK, WHITEGMC
TWD SET403	594A, 592A	ARVINMERITOR, DANA, IHC
TWD SET405	663, 653	ARVINMERITOR, CLARK, DANA, IHC, MACK, STANDARD, VOLVO
TWD SET406	3782, 3720	ARVINMERITOR, DANA, FORD, IHC, WHITEGMC
TWD SET413	HM212049, HM212011	ARVINMERITOR, CLARK, DANA, FRUEHAUF, HENDRICKSON, IHC, IMT, MACK, STANDARD, WHITEGMC
TWD SET414	HM218248, HM218210	ARVINMERITOR, DANA, HENDRICKSON, IMT, KAY-BRUNNER, STANDARD
TWD SET415	HM518445, HM518410	ARVINMERITOR, DANA, FRUEHAUF, HENDRICKSON, IMT

⚠ WARNING: California Proposition 65 - Cancer and Reproductive Harm - www.P65Warnings.ca.gov.

TIMKEN

TEMPER-LOC



TEMPER-LOC AXLE NUTS				
PART NO.	MAJOR THREAD DIAM.	THREADS PER IN	TOOL SOCKET SIZE	OUTER BEARING PART NO.
TWD MER614723	3.48"	12	4-13/16" - 8 POINT	HM518445, HM518410
TWD MER614743	2.625"	16	3-3/4" - 8 POINT	HM212049, HM212011
TWD MER614836	1.50"	12	2-1/2" - 6 POINT	3782, 3720
TWD MER614973	3.25"	12	4-3/8" - 8 POINT	580, 572

⚠ WARNING: California Proposition 65 - Cancer and Reproductive Harm - www.P65Warnings.ca.gov.

TAPERED ROLLER BEARINGS



SET PART NO.	BEARING CONE	CUP
TWD HDSET401	580	5 72
TWD HDSET402	582	572
TWD HDSET403	594A	592A
TWD HDSET405	663	653
TWD HDSET406	3782	3720
TWD HDSET413	HM212049	HM212011
TWD HDSET414	HM218248	HM218210
TWD HDSET415	HM518445	HM518410
TWD HDSET424	555S	552A
TWD HDSET423	6461A	6420

⚠ WARNING: California Proposition 65 - Cancer and Reproductive Harm - www.P65Warnings.ca.gov.



PRO-TORQ ADVANCED AXLE SPINDLE NUTS

	PART NO.	AXLE TYPE	THREAD SIZE	APPLICATION
	TWD 4474723	TRAILER	3.48" - 12	FRUEHAUF PRO-PAR, MERITOR TP
	TWD 4474743	TRAILER	2-5/8" - 16	17,000#-22,500# MERITOR, DANA, EATON, STANDARD FORGE, INGERSOLL
	TWD 4494973	DRIVE	3-1/4" - 12	34,000#-46,000# EATON, MERITOR, DANA, NAVISTAR, 50,000# MACK

⚠ WARNING: California Proposition 65 - Cancer and Reproductive Harm - www.P65Warnings.ca.gov.

HUBODOMETERS

	PART NO.	DESCRIPTION
	TWD 6500532	300 RPK
	TWD 6500537	310 RPK
	TWD 6500539	315 RPK

⚠ WARNING: California Proposition 65 - Cancer and Reproductive Harm - www.P65Warnings.ca.gov.





C

AIR BRAKE PARTS

ABS SYSTEMS	88-96
SPRING BRAKES & COMPONENTS	97-100
AIR DRYERS & COMPONENTS	101-108
VALVES	109-118
GLADHANDS & ACCESSORIES	119-125
AIR HOSES	126-128
AIR ACCESSORIES	129



4S/2M ABS RELAY VALVE KIT



- New Trailer Build Solutions
- ECU and ABS valve are designed to be serviced separately
- ECU Design - PLC Select 2M

PART NO.	DESCRIPTION
MBI AQ963005	<ul style="list-style-type: none"> • 6-PORT ABS RELAY VALVE; TRI-AXLES; 1/2" RESERVOIR PORT; 12V; 3/8" CONT.; 3/8" DEL • 6M POWER CORD EXTENSION; 2M AND 3M SENSOR EXTENSION

⚠ WARNING: California Proposition 65 - Cancer and Reproductive Harm - www.P65Warnings.ca.gov.

4S/2M ABS KIT



- Primarily Competitive Change-Out
- Cost effective solution for competitive system change-out
- ECU and ABS valve are designed to be serviced separately

PART NO.	DESCRIPTION
MBI AQ963002	<ul style="list-style-type: none"> • 4-PORT VALVE; DUAL NIPPLE 1/2" AND 3/4"; 12V; 3/8" PORTS • SPRING BRAKE PRIORITY; 2 PORT RELAY VALVE AND ASSOCIATED CABLES AND ACCESSORIES INCLUDED

⚠ WARNING: California Proposition 65 - Cancer and Reproductive Harm - www.P65Warnings.ca.gov.

ABS RELAY VALVE 2-PORT DELIVERY



- Single Axle Applications (2S/1M or 4S/2M)



PART NO.	DESCRIPTION
MBI AL364040	1/2" RESERVOIR MOUNT; 12V; 3/8" PORTS

⚠ WARNING: California Proposition 65 - Cancer and Reproductive Harm - www.P65Warnings.ca.gov.



ABS RELAY VALVES 4-PORT DELIVERY

- Multiple Axle Applications (2S/1M)
- Three or More Axles (4S/2M)

	PART NO.	DESCRIPTION
	MBI AL430614	<ul style="list-style-type: none"> • 1/2" & 3/4" NIPPLE; 12V; 3/8" PORTS • SERVICE BRAKE PRIORITY
	MBI AL430624	<ul style="list-style-type: none"> • 1/2" & 3/4" NIPPLE; 12V; 3/8" PORTS • SPRING BRAKE PRIORITY
	MBI AL430668	<ul style="list-style-type: none"> • 1/2" & 3/4" NIPPLE; 12V; 3/8" PORTS • SERVICE BRAKE PRIORITY (4-SB PORT)

⚠ WARNING: California Proposition 65 - Cancer and Reproductive Harm - www.P65Warnings.ca.gov.

ABS RELAY VALVE 6-PORT DELIVERY

- Multiple Axle Applications (2S/1M)
- Three or More Axles (4S/2M)

	PART NO.	DESCRIPTION
	MBI AL364041	1/2" RESERVOIR MOUNT; 12V; 3/8" PORTS

⚠ WARNING: California Proposition 65 - Cancer and Reproductive Harm - www.P65Warnings.ca.gov.



2S/1M RELAY VALVE KIT - 6 PORTS

- Multi-Axle Applications
- 6-Port ABS Relay Valve: 1/2" Reservoir Port, 12V, 3/8" Control, 3/8" Delivery

AIR BRAKE PARTS

	PART NO.	DESCRIPTION
	<p>MBI AQ960503</p>	<p>6.0 M POWER CORD EXTENSION; 3.0 M SENSOR EXTENSIONS</p>

⚠ WARNING: California Proposition 65 - Cancer and Reproductive Harm - www.P65Warnings.ca.gov.

4S/2M ABS KIT

Primarily Competitive Change-Out

	PART NO.	DESCRIPTION
	<p>MBI AQ963011</p>	<ul style="list-style-type: none"> • 2-PORT VALVE; DUAL NIPPLE 1/2" AND 3/4"; 12V; 3/8" PORTS • SPRING BRAKE PRIORITY • 2 PORT RELAY VALVE AND ASSOCIATED CABLES AND ACCESSORIES INCLUDED

⚠ WARNING: California Proposition 65 - Cancer and Reproductive Harm - www.P65Warnings.ca.gov.



ELECTRONIC CONTROL UNITS (ECU)

	PART NO.	DESCRIPTION
	MBI AQ964110	<ul style="list-style-type: none"> • PLC/PLUS 19 PIN • PLC ECU, SLH-A7, 19 PIN, 2 KEYS-DIAGONAL
	MBI AL919338	<ul style="list-style-type: none"> • PLC SELECT 1M ECU, DIN 12V, SLH-A7 MULTI-AXLE (NON-STEER AXLES) • PLC SELECT 1M SUPPORTS ALL 2S/1M APPLICATIONS
	MBI AL919342	<ul style="list-style-type: none"> • PLC SELECT 2M ECU, DIN 12V, SLH-A7, MULTI-AXLE • PLC SELECT 2M SUPPORTS 4S/2M AND 2S/2M APPLICATIONS

⚠ WARNING: California Proposition 65 - Cancer and Reproductive Harm - www.P65Warnings.ca.gov.

ECU UPGRADE KITS

- Wheel speed sensor and trailer power connects directly to ECU (no intermediate cables required)
- Single fastener design assures easy serviceability
- Potted ECU enclosure provides excellent protection from the environment

	PART NO.	DESCRIPTION
	MBI AQ960502	2S/1M A8 ECU UPGRADE KIT; PLC SELECT ECU
	MBI AQ964110	2S/1M A7 ECU UPGRADE KIT; PLC SELECT ECU
	MBI AQ964111	4S/2M ECU UPGRADE KIT; 2M PLC SELECT ECU

⚠ WARNING: California Proposition 65 - Cancer and Reproductive Harm - www.P65Warnings.ca.gov.



UNIVERSAL SENSOR EXTENSION

	PART NO.	LENGTH	DESCRIPTION
	MBI AL919803	6.6 FEET (2 M)	ECU END HAS 2-PIN FEMALE CONNECTOR, SENSOR END HAS 2-PIN MALE CONNECTOR

⚠ WARNING: California Proposition 65 - Cancer and Reproductive Harm - www.P65Warnings.ca.gov.

ABS SENSORS WITH RETAINER CLIP

	PART NO.	LENGTH	DESCRIPTION
	MBI AL10271914	1.6 FEET (0.5 M)	SENSOR - 90° BODY WITH CLIP
	MBI AL10271915	6.6 FEET (2 M)	SENSOR - 90° BODY WITH CLIP
	MBI AL1027196	1.6 FEET (0.5 M)	SENSOR - STRAIGHT BODY WITH CLIP

⚠ WARNING: California Proposition 65 - Cancer and Reproductive Harm - www.P65Warnings.ca.gov.

ABS SERVICE KIT

	PART NO.	DESCRIPTION
	MBI AQ15473	5-WAY TERMINAL KIT, MALE FOR POWER CORD

⚠ WARNING: California Proposition 65 - Cancer and Reproductive Harm - www.P65Warnings.ca.gov.



ASSEMBLY KITS

	PART NO.	DESCRIPTION
	TWD R955321	<ul style="list-style-type: none"> • TCS2 ASSMY KIT • ABS SYSTEM: 2S/2M, 4S/2M • CONTAINS AN ENHANCED EASY-STOP ECU/VALVE AND A POWER CABLE ADAPTER FOR USE WITH THE EXISTING EASY-STOP POWER CABLE
	TWD R955344	<ul style="list-style-type: none"> • 2S/1M W/PWR ADT • ABS SYSTEM: 2S/ 1M STANDARD TRAILERS • CONTAINS AN ENHANCED EASY-STOP ECU/VALVE AND A POWER CABLE ADAPTER FOR USE WITH THE EXISTING EASY-STOP POWER CABLE

⚠ WARNING: California Proposition 65 - Cancer and Reproductive Harm - www.P65Warnings.ca.gov.

ABS SENSOR KITS

ABS SENSOR KITS		
	PART NO.	LENGTH
	TWD R955335	1'
	TWD R955336	3'
	TWD R955341	5.8'
	TWD R955342	6.6'

⚠ WARNING: California Proposition 65 - Cancer and Reproductive Harm - www.P65Warnings.ca.gov.



ABS SENSOR KITS (continued)

STRAIGHT SENSOR		
	PART NO.	LENGTH
	TWD R955338	5.8'

⚠ WARNING: California Proposition 65 - Cancer and Reproductive Harm - www.P65Warnings.ca.gov.



TCS/ECU VALVE ASSEMBLIES

	PART NO.	DESCRIPTION
	TWD S4005001030	<ul style="list-style-type: none"> • TCS 2 ECU/VALVE • ABS SYSTEM: 2S/2M, 4S/2M, 4S/3M PREMIUM • APPLICATION: ENHANCED EASY-STOP • RELATED MODULATOR VALVE: S4008506020 (DUAL) <p>USED ON TRAILERS PRODUCED AFTER MARCH 1, 2001. COMPLETE ENHANCED EASY-STOP ASSEMBLY CONSISTS OF AN ECU, SINGLE OR DUAL MODULATOR VALVE AND, FOR THE BASIC, A BRACKET. REPLACEMENT PARTS INCLUDE ECU OR MODULATOR VALVE, MOUNTING SCREWS, O-RING, GREASE, AND INSTALLATION INSTRUCTIONS.</p>
	TWD S4461082010	<ul style="list-style-type: none"> • ECU TCS11 2S/1M • ABS SYSTEM: 2S/1M BASIC (MSH) - RECOMMENDED FOR USE WITH STANDARD TRAILERS. DO NOT USE WITH TURNABLES, STEERABLES OR DOLLIES <p>USED ON TRAILERS PRODUCED AFTER MARCH 1, 2001. INCLUDES ECU, MOUNTING SCREWS, O-RING, GREASE, AND INSTALLATION INSTRUCTIONS.</p>

⚠ WARNING: California Proposition 65 - Cancer and Reproductive Harm - www.P65Warnings.ca.gov.



ASSEMBLY KITS

	PART NO.	DESCRIPTION
	TWD S4721950330	<ul style="list-style-type: none"> • ANTI-LOCK BRAKE SYSTEM RELAY VALVE • FOR USE ON TRAILERS PRODUCED APRIL 1, 1999 OR LATER <p>USE WITH BAYONET STYLE CABLE CONNECTORS. 12 VOLT, 3-4 PSI CRACK PRESSURE, 2 SUPPLY PORTS, 4 DELIVERY PORTS. FOR 3M ENHANCED EASY-STOP OR 2M/3M EASY-STOP UNITS.</p>
	TWD R955378	<ul style="list-style-type: none"> • SOL VALVE KIT • FOR USE ON TRAILERS PRODUCED PRIOR TO APRIL 1, 1999 • KIT INCLUDES MODULATOR VALVE AND STRAIGHT ADAPTER CABLE • FOR 3M ENHANCED EASY-STOP OR 2M/3M EASY-STOP UNITS

⚠ WARNING: California Proposition 65 - Cancer and Reproductive Harm - www.P65Warnings.ca.gov.

SENSOR EXTENSIONS W/PLUG





ABS SENSOR KITS				
	PART NO.	LENGTH	APPLICATION	FUNCTION
	TWD S4497130180	6' (1.8 M)	USE WITH ALL VERSIONS OF EASY-STOP AND ENHANCED EASY-STOP	TWO-WIRE CABLE THAT CONNECTS THE WHEEL END SENSORS TO THE ECU
	TWD S4497130300	10' (3 M)		
	TWD S4497130500	16' (5 M)		

ADAPTER CABLE

	PART NO.	DESCRIPTION
	TWD S8946073120	<ul style="list-style-type: none"> • TSC2 POW CB ADP • CONNECTS EASY-STOP POWER CABLE TO AN ENHANCED EASY-STOP ECU/MODULATOR VALVE ASSEMBLY

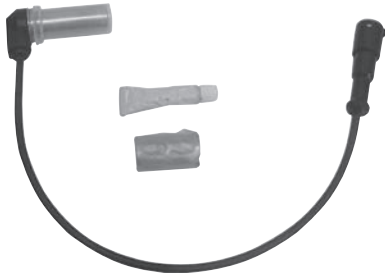
⚠ WARNING: California Proposition 65 - Cancer and Reproductive Harm - www.P65Warnings.ca.gov.

ABS SENSORS

	PART NO.	DESCRIPTION
	TWD S71914	<ul style="list-style-type: none"> • RIGHT ANGLE ABS SENSOR • 0.5 M CABLE, REPLACES HALDEX AL10271914
	TWD S28080	<ul style="list-style-type: none"> • RIGHT ANGLE ABS SENSOR • 0.3 M CABLE, REPLACES MERITOR R955335
	TWD S28140	<ul style="list-style-type: none"> • RIGHT ANGLE ABS SENSOR • 2.0 M CABLE, REPLACES MERITOR R955342
	TWD S28090	<ul style="list-style-type: none"> • RIGHT ANGLE ABS SENSOR • 0.9 M CABLE, REPLACES MERITOR R955336
	TWD S28130	<ul style="list-style-type: none"> • RIGHT ANGLE ABS SENSOR • 1.8 M CABLE, REPLACES MERITOR R955341
	TWD S30180	<ul style="list-style-type: none"> • RIGHT ANGLE ABS EXTENSION CABLE • 1.8 M EXTENSION, REPLACES MERITOR S4497130180
	TWD S30300	<ul style="list-style-type: none"> • RIGHT ANGLE ABS EXTENSION CABLE • 3.0 M EXTENSION, REPLACES MERITOR S4497130300
	TWD S30500	<ul style="list-style-type: none"> • RIGHT ANGLE ABS EXTENSION CABLE • 5.0 M EXTENSION, REPLACES MERITOR S4497130500
	TWD S29000	<ul style="list-style-type: none"> • STRAIGHT ABS SENSOR • 1.8 M CABLE, 79 MM SENSOR, REPLACES MERITOR R955338
	TWD S29190	<ul style="list-style-type: none"> • STRAIGHT ABS SENSOR • 1.8 M CABLE, 65 MM SENSOR, REPLACES MERITOR R955337
	TWD S29710	<ul style="list-style-type: none"> • STRAIGHT ABS SENSOR • 2.0 M CABLE, 79 MM SENSOR, REPLACES MERITOR R955349
	TWD S50010	<ul style="list-style-type: none"> • STRAIGHT ABS SENSOR • 0.4 M CABLE, 60.6 MM SENSOR, REPLACES MERITOR S4410350010
	TWD S19802	<ul style="list-style-type: none"> • HALDEX STYLE ABS EXTENSION CABLES • 1.5 M CABLE, REPLACES AL919802
	TWD S19803	<ul style="list-style-type: none"> • HALDEX STYLE ABS EXTENSION CABLES • 2.0 M CABLE, REPLACES AL919803
	TWD S19804	<ul style="list-style-type: none"> • HALDEX STYLE ABS EXTENSION CABLES • 2.5 M CABLE, REPLACES AL919804
	TWD S19805	<ul style="list-style-type: none"> • HALDEX STYLE ABS EXTENSION CABLES • 3.0 M CABLE, REPLACES AL919805

WARNING: California Proposition 65 - Cancer and Reproductive Harm - www.P65Warnings.ca.gov.



GOLD SEAL COMBINATION SPRING BRAKES - SIZE 30/30

	PART NO.	DESCRIPTION
	MBI GC3030	NO CLEVIS
	MBI GC3030CW	WELDED CLEVIS (VOLVO & MACK)
	MBI GC3030L	LONG STROKE
	MBI GC3030LCW	LONG STROKE, WELDED CLEVIS (FREIGHTLINER & NAVISTAR)
	MBI GC3030LS4CW	LONG STROKE, WELDED CLEVIS (TRAILER, INTRAAX®)
	MBI GC3030LS5CW	LONG STROKE, WELDED CLEVIS (TRAILER, VANTRAAX®)
	MBI GC3030S4CW	WELDED CLEVIS (TRAILER, INTRAAX®)
	MBI GC3030S5CW	WELDED CLEVIS (TRAILER, VANTRAAX®)

⚠ WARNING: California Proposition 65 - Cancer and Reproductive Harm - www.P65Warnings.ca.gov.

GOLD SEAL PIGGYBACK SPRING BRAKES - SIZE 30/30

	PART NO.	DESCRIPTION
	MBI GP3030K	PIGGYBACK KIT
	MBI GP3030LK	PIGGYBACK KIT, LONG STROKE

⚠ WARNING: California Proposition 65 - Cancer and Reproductive Harm - www.P65Warnings.ca.gov.



PIGGYBACK SPRING BRAKES - SIZE 30/30

	PART NO.	DESCRIPTION
	MBI HD3030KIT	PIGGYBACK KIT, SIZE 30/30

⚠ WARNING: California Proposition 65 - Cancer and Reproductive Harm - www.P65Warnings.ca.gov.

SERVICE CHAMBER BRAKES

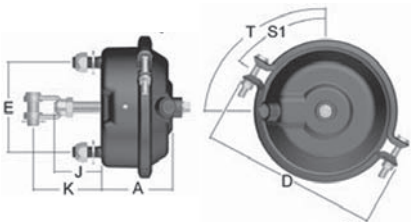
	PART NO.	DESCRIPTION
	MBI SC09	SIZE T-09
	MBI SC16	SIZE T-16
	MBI SC20	SIZE T-20
	MBI SC24	SIZE T-24
	MBI SC30	SIZE T-30

⚠ WARNING: California Proposition 65 - Cancer and Reproductive Harm - www.P65Warnings.ca.gov.

WEDGE PIGGYBACK REPLACEMENT

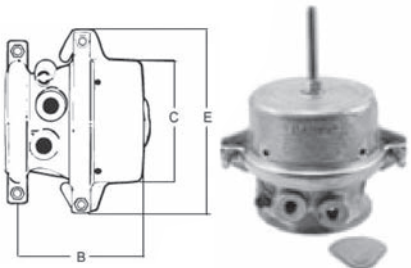
	PART NO.	DESCRIPTION
	MBI 1212015	<p>PIGGYBACK SIZE 1212 AIR PORT THREADS: 3/8-18 NPTF AVAILABLE STROKE: 1.75", 44 MM B: 5.0", 127 MM C: 4.8", 122 MM E: 7.8", 198 MM</p>

⚠ WARNING: California Proposition 65 - Cancer and Reproductive Harm - www.P65Warnings.ca.gov.



GOLD SEAL AND LIFE SEAL REPLACEMENT PARTS

AIR BRAKE PARTS

	PART NO.	DESCRIPTION
	MBI DS1	<ul style="list-style-type: none"> • DUST SHIELD • 5/8" PUSH ROD, 1" (25.4 MM) HOLE
	MBI RT1	<ul style="list-style-type: none"> • RELEASE TOOL • FOR ALL DDSB EXCEPT XX36
	MBI RTP1	<ul style="list-style-type: none"> • RELEASE TOOL PLUG - BLUE • FOR GOLD SEAL & CLAMP STYLE EXCEPT XX36
	MBI RTP2	<ul style="list-style-type: none"> • RELEASE TOOL PLUG • FOR MIDLAND STYLE
	MBI CB30S1	<ul style="list-style-type: none"> • T-30 CLAMP BAND KIT • CONTAINS TWO BOLT STYLE CLAMP BANDS
	MBI CF1	<ul style="list-style-type: none"> • FORGED CLEVIS • 1/2 PIN, 1/2-20 UNF
	MBI CF2	<ul style="list-style-type: none"> • FORGED CLEVIS • 1/2 PIN, 5/8-18 UNF
	MBI CF3	<ul style="list-style-type: none"> • FORGED CLEVIS • 5/8 PIN, 5/8-18 UNF
	MBI DP30	ANCHORLOK T-30 DIAPHRAGM

⚠ WARNING: California Proposition 65 - Cancer and Reproductive Harm - www.P65Warnings.ca.gov.

RANGER BRAKE

AIR BRAKE PARTS

SERVICE CHAMBERS



PART NO.	UNIT SIZE	"A"
TWD HD12S	12	3.60"
TWD HD16S	16	4.20"
TWD HD20S	20	4.90"
TWD HD24S	24	4.90"
TWD HD30S	30	5.50"
TWD HD36S	36	6.50"
LONG STROKE		
TWD HD20S-LS	20	4.90"
TWD HD24S-LS	24	4.90"
TWD HD30S-LS	30	5.50"
LONG ROD		
TWD HD30S-LR	30	5.50"

⚠ WARNING: California Proposition 65 - Cancer and Reproductive Harm - www.P65Warnings.ca.gov.

SPRING BRAKES

PART NO.	DESCRIPTION	STROKE	CLEVIS
TWD HD3030	3030 TANDEM (NO CLEVIS)	2.50"	NO
TWD HD3030LS	3030 TANDEM LONG-STROKE	3.00"	NO
TWD HD3030VC	3030 TANDEM (NO CLEVIS)	2.50"	NO
TWD HD3030SB	3030 TANDEM (NO CLEVIS)	2.50"	NO
TWD HD3030C	3030 TANDEM	2.50"	YES
TWD HD2424C	2424 TANDEM	2.50"	YES
TWD HD2430C	2430 TANDEM	2.50"	YES
TWD HD3036C	3036 TANDEM	2.50"	YES
TWD HD3636C	3636 TANDEM	3.00"	YES
TWD HD2430C-LS	2430 TANDEM LONG-STROKE	3.00"	YES
TWD HD3030C-LS	3030 TANDEM LONG-STROKE	3.00"	YES
TWD HD3030-KIT	3030 PIGGYBACK KIT (NOW WITH WIDE CLAMP DESIGN)	2.50"	—
TWD HD3030LS-KIT	3030 PIGGYBACK KIT LONG-STROKE (NOW WITH WIDE CLAMP DESIGN)	3.00"	—





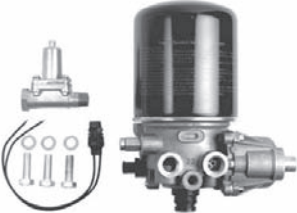

⚠ WARNING: California Proposition 65 - Cancer and Reproductive Harm - www.P65Warnings.ca.gov.

AIR DRYERS

	PART NO.	DESCRIPTION
	TWD H955205	WABCO AIR DRYER, 12 V.D.C.

⚠ WARNING: California Proposition 65 - Cancer and Reproductive Harm - www.P65Warnings.ca.gov.

AIR DRYER COMPONENTS

	PART NO.	DESCRIPTION
	TWD H950011	REPLACES MERITOR R950011, BENDIX 5008414, ADSP CARTRIDGE
	TWD H950013	TURBO CUT-OFF VALVE KIT
	TWD H950014	PURGE VALVE KIT
	TWD H950015	12V HEATER REPAIR KIT, DATE CODE 0994 AND LATER
	TWD H950017	OUTLET CHECK VALVE KIT
	TWD HA72420	ALCOHOL EVAPORATOR REPLACES HALDEX A72420

⚠ WARNING: California Proposition 65 - Cancer and Reproductive Harm - www.P65Warnings.ca.gov.

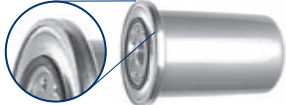

AIR DRYER COMPONENTS (continued)

	PART NO.	DESCRIPTION
	TWD HT224	CARTRIDGE SPIN-ON TYPE SKF TURBO 2000 ORIGINAL EARLIER DESIGN DRYERS

⚠ WARNING: California Proposition 65 - Cancer and Reproductive Harm - www.P65Warnings.ca.gov.



TWD BEN286934N AD-2® AIR DRYER

- End Cover Available Remanufactured Exchange
- V.M.R.S. 13-010-033

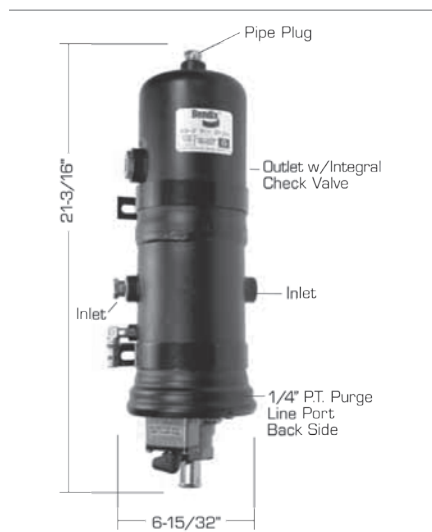

SERVICE/MAINTENANCE INFORMATION MAINTENANCE KITS	
PART NO.	DESCRIPTION
TWD 286718	DESICCANT CARTRIDGE REFILL KIT
TWD 101900X	REMAN. DESICCANT CARTRIDGE
TWD 287053N	PURGE VALVE MAINTENANCE KIT
TWD 102657N	THERMOSTAT MAINTENANCE KIT

⚠ WARNING: California Proposition 65 - Cancer and Reproductive Harm - www.P65Warnings.ca.gov.

TWD BEN800243 AD-9® AIR DRYER

- More Desiccant Works Longer
- Compact Size Saves Space
- Remanufactured Exchange
- V.M.R.S. 13-010-033

SERVICE NEW PART NO.	PURGE VOLUME	PURGE VALVE	PORT SIZE (PT.)	HEATER
TWD H065225	STANDARD	HARD	1/2"	12V/75W
TWD BEN065647 *	STANDARD	SOFT	1/2"	12V/75W
TWD BEN065228	EXTENDED	HARD	3/4"	12V/75W
TWD H065066	EXTENDED	HARD	3/4"	24V/75W

*DROP IN: For use with Holset Series QE Compressors only

**Freightliner® DTNA – Cascadia: Other Bendix® AD-9® Air Dryer Models can not be used in this Application.

⚠ WARNING: California Proposition 65 - Cancer and Reproductive Harm - www.P65Warnings.ca.gov.



TWD BEN800243 AD-9® AIR DRYER (continued)

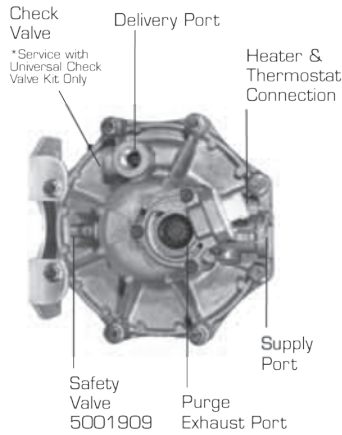
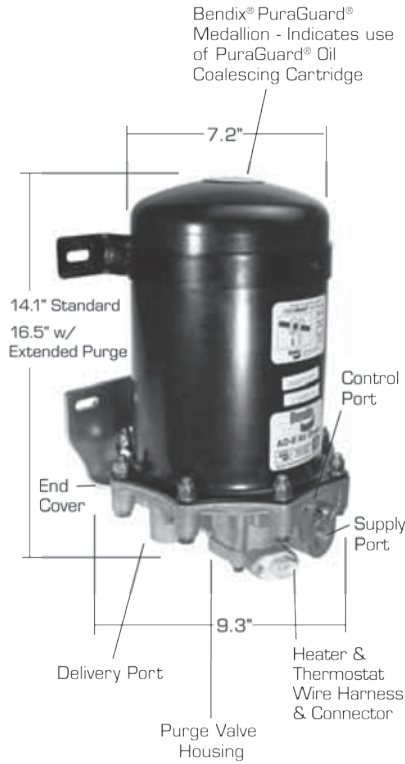

NEW STYLE END COVER

MAINTENANCE KITS AND SERVICE PARTS	
CHECK VALVE KITS	
PART NO.	DESCRIPTION
TWD BEN107800N	CHECK VALVE KIT 1/2" (OLD STYLE END COVER ONLY)
TWD BEN107799	CHECK VALVE KIT 3/4" (OLD STYLE END COVER ONLY)
DESICCANT CARTRIDGE KITS	
PART NO.	DESCRIPTION
TWD BEN107794X	REMAN EXCHANGE
TWD BEN107796	SERVICE NEW
TWD BEN107796PG	BENDIX® PURAGUARD® OIL COALESCING CARTRIDGE, SERVICE NEW
PURGE VALVE KITS	
PART NO.	DESCRIPTION
TWD BEN5005037	HARD SEAT PURGE VALVE MAINTENANCE KIT
TWD BEN800405	SOFT SEAT PURGE VALVE KIT 12V/75W
TWD BEN5004338	SOFT SEAT PURGE VALVE KIT 24V/75W
TWD BEN5005893	SOFT SEAT PURGE VALVE MAINTENANCE KIT
TWD BEN5004339	DLU PURGE VALVE KIT 12V/75W
TWD BEN5004341X	REMAN. SOFT SEAT PURGE VALVE ASSY KIT 12V/75W
HEATER KITS	
PART NO.	DESCRIPTION
TWD BEN109578	HEATER & THERMOSTAT KIT 12V/75W
TWD BEN109579	HEATER & THERMOSTAT KIT 24V/75W
TWD BEN109871N	WIRING HARNESS ELECTRICAL SPLICING KIT
MISCELLANEOUS KITS	
PART NO.	DESCRIPTION
TWD BEN107695	BRACKET KIT
TWD BEN5003838	EXHAUST COVER KIT - BENDIX® AD-9® AIR DRYER ONLY

AIR BRAKE PARTS

⚠ WARNING: California Proposition 65 - Cancer and Reproductive Harm - www.P65Warnings.ca.gov.



TWD BEN800972 AD-SP® AIR DRYER

- System Purge • V.M.R.S. 13-010-033

AIR BRAKE PARTS



AIR DRYERS & FIELD INSTALLATION KITS		
SERVICE NEW PART NO.	HEATER *	NOTE
TWD BEN131031	12V/90W	W/ SC-PR™ VALVE
TWD BEN800887	12V/90W	-
TWD BEN800972	24V/90W	-

MAINTENANCE KITS AND SERVICE PARTS	
PART NO.	DESCRIPTION
TWD BEN5008414	DESICCANT CARTRIDGE KIT
TWD BEN5008414PG	BENDIX® PURAGUARD® OIL COALESCING CARTRIDGE KIT
TWD BEN109995	PURGE VALVE KIT
TWD BEN5005624	CHECK VALVE KIT
TWD BEN109495	HEATER & THERMOSTAT KIT - 12V
TWD BEN109871N	WIRE HARNESS & SPLICE KIT

*12 & 24 Volt AD-SP Air Dryers are identified by connector color: White = 12V, Gray = 24V

⚠ WARNING: California Proposition 65 - Cancer and Reproductive Harm - www.P65Warnings.ca.gov.

TWD BEN800243 AD-IP® AIR DRYER

- Integral Purge Air Dryer • V.M.R.S. 13-010-033

Bendix® PuraGuard® Medallion - Indicates use of PuraGuard® Oil Coalescing Cartridge

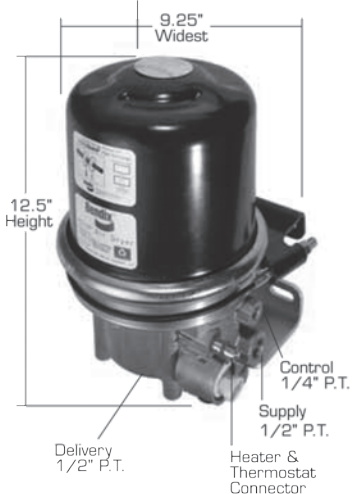

AIR DRYERS & FIELD INSTALLATION KITS	
PART NO.	DESCRIPTION
TWD BEN109498	CARTRIDGE BOLT KIT
TWD BEN065624	DESICCANT CARTRIDGE SERVICE NEW
TWD BEN109493X	DESICCANT CARTRIDGE REMANUFACTURED
TWD BEN065624PG	BENDIX® PURAGUARD®
TWD BEN109494	DELIVERY CHECK VALVE KIT
TWD BEN109495	12 VOLT HEATER & THERMOSTAT KIT
TWD BEN109496	24 VOLT HEATER & THERMOSTAT KIT
TWD BEN5001247	MOUNTING BRACKET KIT
TWD BEN109871N	WIRING HARNESS & SPLICING KIT

⚠ WARNING: California Proposition 65 - Cancer and Reproductive Harm - www.P65Warnings.ca.gov.

IF THE BENDIX® PURAGUARD® OIL COALESCING CARTRIDGE IS REPLACED, IT MUST BE REPLACED WITH A LIKE UNIT.



AIR BRAKE PARTS

TWD BEN800243 AD-IP® AIR DRYER (continued)

SERVICE NEW PART NO.	REMAN. EXCH. PART NO.	SUPPLY PORT (P.T.)	DELIVERY PORT (P.T.)	HEATER	COMMENTS
TWD BEN065612	MBI 109477X	1/2"	1/2"	12V/90W	NOTES 2, 3, 4
TWD BEN800576	MBI 5005556X	1/2"	1/2"	12V/90W	NOTES 2, 3, 4, 5

Notes: 1. No upper or lower mounting bracket 2. 12 & 24 Volt Air Dryers are identified by connector color: White = 12V, Gray = 24V
 3. Center to center of slots in both mounting brackets 5.64" 4. Includes 5001247 (mounting bracket kit) 5. Extended Purge 6. Includes Drop-In Check Valve Kit

⚠ WARNING: California Proposition 65 - Cancer and Reproductive Harm - www.P65Warnings.ca.gov.

DRM™ DRYER RESERVOIR MODULE WITH BENDIX® AD-IS® AIR DRYER

SERVICE NEW PART NO.	PORT PLUG	SUSPENSION PORT	ACCESSORY PORTS (QTY)	HEATER
TWD BEN800383	WITHOUT	1/4" NPT	1/4" NPT (4)	12V/90W
TWD BEN801330		NONE	NONE	12V/90W

RESERVOIRS FOR BENDIX® DRM™ DRYER RESERVOIR MODULE

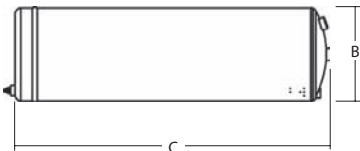
	SERVICE NEW PART NO.	'B' DIA.	'C' LENGTH	NO. OF COMPARTMENTS	NOTE
	TWD BEN5009107N	9"	55.5"	2	ALUMINUM

PURGE VOLUME RESERVOIRS

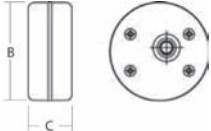
	SERVICE NEW PART NO.	MOUNTING BRACKET	'B' DIA.	'C' LENGTH	VOLUME (CUBIC INCHES)	NOTE
	TWD BEN5008574	4 HOLE SAE MOUNTING	9"	3.9"	200	STANDARD

**For use on vehicle with FreedomLine transmission & has an integral 610 in 3 chamber
 PTC = Push-to-Connect

⚠ WARNING: California Proposition 65 - Cancer and Reproductive Harm - www.P65Warnings.ca.gov.



ALCOHOL EVAPORATOR & COMPONENTS



	PART NO.	DESCRIPTION
	MBI A72420	ALCOHOL EVAPORATOR WITH SAFETY VALVE, CAPACITY: 40 OZ OF METHYL ALCOHOL, PORTS: 1/2" NPT
	MBI A75962	SAFETY VALVE ONLY (OEM# AD75962)
	MBI A39219	REPAIR KIT TO REPLACE RUBBLER PARTS
	MBI A48373	TETRASEAL (OEM# AD48373)

⚠ WARNING: California Proposition 65 - Cancer and Reproductive Harm - www.P65Warnings.ca.gov.



MERITOR

WABCO SYSTEM SAVER 1200 & 1800 REPLACEMENTS

	REPL. KIT PART NO.	PORT SIZES/ DETAILS	DESCRIPTION OF AIR DRYER	AIR DRYER	CARTRIDGE
	TWD R955205	Port 1 (supply): .50"-14 NPTF	12-volt System Saver 1000/1200. Production number 432 413 001 0 or 432 413 003 0.	SRWABK118	TWD R950011
	TWD R955206	Port 21 (delivery): .50"-14 NPTF	24-volt System Saver 1200. Prod number 432 413 002 0 or 432 413 004 0.	SRWABK119	
	TWD R955207	Port 4 (control): .25"-18 NPTF	12-volt System Saver 1200E. Production number 432 413 006 0.	S432 413 010 0	
		Port 22 (purge tank): .25"-18 NPTF	Coalescing Version of 12-volt System Saver 1200P	S432 421 048 0	
	TWD R955079		12-volt System Saver 1200P. Production number 432 421 009 0.	S432 413 024 0	TWD R950011
	TWD R955300		24-volt System Saver 1200P. Production number 432 421 010 0.	S432 413 025 0	
	TWD R955315		Coalescing Version of 12-volt System Saver 1200UP.	S432 421 033 0	
	TWD R955082				

Replacement Kits contain: Air Dryer Base, Cartridge, Label, Heater Power Harness, Mounting Hardware and Pressure Controlled Check Valve.

Alphabetical designations of Air Dryers:

- E: Holset style compressor function. Dryer has external econ line
- P: External purge tank is used for desiccant regeneration
- U: Discharge line is used for unloading compressor
- UP: Discharge line for unloading compressor and external purge tank

⚠ WARNING: California Proposition 65 - Cancer and Reproductive Harm - www.P65Warnings.ca.gov.



DESICCANT CARTRIDGES

	PART NO.	APPLICATION INFORMATION
	TWD R950011	FOR USE ON SYSTEM SAVER 1000 AND 1200 SERIES AND TWIN AIR DRYERS
	TWD R950048	FOR USE ON SYSTEM SAVER 1800 SERIES AIR DRYERS. CAN BE RETROFITTED TO AN EXISTING SS1200 AIR DRYER TO INCREASE DRYING CAPACITY.
	TWD R950068	COALESCING VERSION OF SYSTEM SAVER 1200 AND TWIN AIR DRYER AND OTHER SPIN-ON DRYER APPLICATIONS. IMPROVED OIL SEPARATION VERSES CONVENTIONAL CARTRIDGES. REQUIRES MORE FREQUENT SERVICE INTERVALS.
	TWD R950069	COALESCING VERSION OF SYSTEM SAVER 1800 AIR DRYER AND OTHER SPIN-ON DRYER APPLICATIONS. IMPROVED OIL SEPARATION VERSES CONVENTIONAL CARTRIDGES. REQUIRES MORE FREQUENT SERVICE INTERVALS.

⚠ WARNING: California Proposition 65 - Cancer and Reproductive Harm - www.P65Warnings.ca.gov.

SS1200/SS1800 AIR DRYER REPAIR KITS

	PART NO.	QTY	DESCRIPTION	APPLICATION INFORMATION
<p style="text-align: center;">HEATER REPAIR KIT</p>	TWD R950015	2	MOUNTING SCREW	12-VOLT HEATER KIT FOR DRYERS WITH DATE CODE 0994 AND LATER. FOR ALL SYSTEM SAVER SERIES AIR DRYERS
		1	WIRING CONNECTOR	
		1	O-RING	
		1	WIRE - HEATER	
		1	HEATER	
		1	THERMOSTAT	
		1	PLASTIC RETAINER	
		1	RETAINER SCREW	
<p style="text-align: center;">REGENERATION VALVE KIT</p>	TWD R950012	1	DIAPHRAGM	OLD STYLE REGENERATION VALVE HOUSING IS NO LONGER IN PRODUCTION. REPLACED BY NEW VALVE HOUSING WITH O-RING AND FILTER. FOR DRYERS WITH DATE CODES EARLIER THAN 2295. FOR SS1200 AND SS1800 MODELS
		1	CAP	
		1	COMPRESSION SPRING	
		1	REGENERATION VALVE HOUSING WITH O-RING AND FILTER	
		4	CAPSCREW	
		1	FILTER	

⚠ WARNING: California Proposition 65 - Cancer and Reproductive Harm - www.P65Warnings.ca.gov.



SS1200/SS1800 AIR DRYER REPAIR KITS (continued)

TURBO CUT-OFF VALVE KIT

	PART NO.	QTY	DESCRIPTION	APPLICATION INFORMATION
	TWD R950013	1	PLUG	IF YOU ARE REPLACING THE TURBO CUT-OFF VALVE ON A SYSTEM SAVER 1200E AIR DRYER, PLEASE CONTACT MERITOR WABCO AT 800-535-5560 FOR PART NUMBER INFORMATION
		1	RETAINER RING	
		1	COVER	
		1	O-RING	
		1	COMPRESSION SPRING (NOT USED IN SS1200U AIR DRYERS)	
		1	PISTON (VALVE)	
		1	LIP SEAL	
		1	GREASE PAK	

PURGE VALVE KIT

	PART NO.	QTY	DESCRIPTION	APPLICATION INFORMATION
	TWD R950014	1	O-RING	INSTALL WASHER WITH LIP FACING PISTON SEAT. SHIMS MAY NOT BE INCLUDED IN THIS KIT. IF NOT INCLUDED, THEY ARE NOT REQUIRED. IF INCLUDED, THEY MUST BE INSTALLED ABOVE AND BELOW THE SPRING. KIT IS FOR USE ON ALL SINGLE CARTRIDGE DRYERS WITH U.S. (NPTF) PORTS.
		1	WASHER	
		1	PISTON O-RING	
		1	PISTON SEAT	
		1	PISTON	
		1	SHIM	
		1	COMPRESSION SPRING	
		1	O-RING	
		1	VALVE HEAD	
		1	RETAINER RING	
		1	GREASE PAK	

	TWD R955047	1	O-RING	SHIM MAY NOT BE INCLUDED WITH THIS KIT. IF NOT INCLUDED, IT IS NOT REQUIRED. IF INCLUDED, INSTALL BELOW COMPRESSION SPRING. FOR USE WITH ALL SYSTEM SAVER SERIES AIR DRYERS.
		1	PISTON ASSEMBLY	
		1	SPRING	
		1	O-RING	
		1	SHIM	
		1	VALVE BODY	
		1	RETAINER RING	
		1	GREASE PAK	

OUTLET CHECK VALVE KIT

	PART NO.	QTY	DESCRIPTION	APPLICATION INFORMATION
	TWD R950017	1	O-RING	KIT IS FOR USE ON SS1200 AND SS1800 AIR DRYERS WITH U.S. (NPTF) PORTS
		1	COMPRESSION SPRING	
		1	WASHER	
		1	RETAINER RING	
		1	GREASE PAK	

⚠ WARNING: California Proposition 65 - Cancer and Reproductive Harm - www.P65Warnings.ca.gov.



BENDIX® VALVES

SR-7 SPRING BRAKE MODULATING VALVES

	PART NO.	MOUNTING STUD		CONTROL PORT		BALANCE PORT	
		THD.	LENGTH	SIZE	FITTING	SIZE	FITTING
	TWD BENK021557	3/8" - 16	.94"	1/4" NPT	N/A	1/4" NPT	N/A
	TWD BENK021558	3/8" - 16	.94"	3/8" PTC	STRAIGHT	3/8" PTC	STRAIGHT
	TWD BENK021562	N/A	N/A	1/4" NPT	N/A	1/4" NPT	N/A

ST-3 SAFETY VALVE

	PART NO.	PIPE THREAD	PRESSURE SETTING
<p style="text-align: center;">ST-3[™] Safety Valve</p>	TWD BEN284142N	1/4"	150 PSI

ST-4 SAFETY VALVES

	PART NO.	PRESSURE SETTING	THREAD	NO. OF HOLES
	TWD BEN131081	250 PSI	1/2 - 14 NPT	2
	TWD BEN800350*	150 PSI	1/4 - 18 NPT	1
	TWD BEN801116	250 PSI	7/8 - 14 UNF-2A	2

*Used in conjunction with: Dryer Reservoir Module

WARNING: California Proposition 65 - Cancer and Reproductive Harm - www.P65Warnings.ca.gov.



BENDIX® VALVES (continued)

TP-3 TRACTOR PROTECTION VALVES

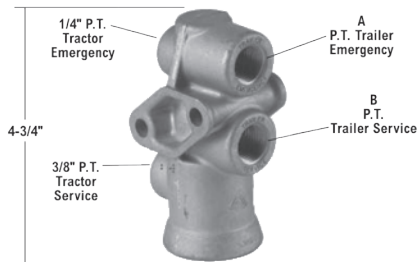

PART NO.	TRAILER EMERGENCY (A)	TRAILER SERVICE (B)	DESCRIPTION
TWD BEN279000N	1/2" P.T.	1/2" P.T.	USED WITH PP-3™ CONTROL VALVE OR PP-7™ TRAILER SUPPLY VALVE
TWD BENOR279000X	1/2" P.T.	1/2" P.T.	

TP-3DC TRACTOR PROTECTION VALVE

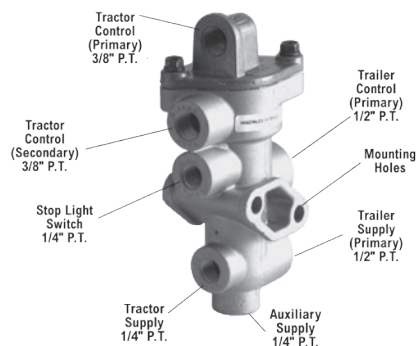

PART NO.	DESCRIPTION
TWD BEN065706	TRACTOR PROTECTION VALVE

TP-5 TRACTOR PROTECTION VALVES

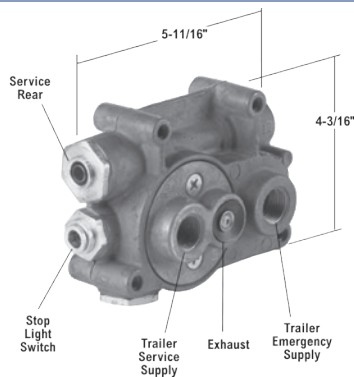
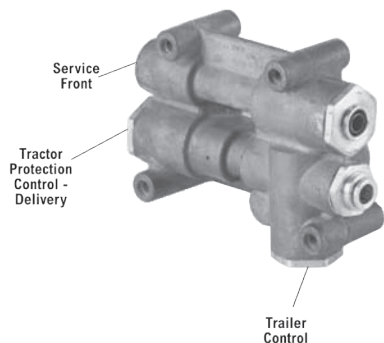

PART NO.	SERVICE (REAR & FRONT)	STOP LIGHT SWITCH	TRAILER CONTROL	TRAILER SERVICE	TRAILER EMERGENCY	TRACTOR PROTECTION CONTROL DELIVERY
TWD BENOR288605X	3/8" NPT	1/4" NPT	3/8" NPT	1/2" NPT	1/2" NPT	3/8" NPT

⚠ WARNING: California Proposition 65 - Cancer and Reproductive Harm - www.PG5Warnings.ca.gov.



BENDIX® VALVES (continued)

TW-1 CONTROL VALVES

	PART NO.	LEVER MATERIAL
	TWD BEN229635N	STEEL-CHROME, DIAL PLATE NOT INCLUDED
	TWD BENOR229635X	STEEL-CHROME, DIAL PLATE NOT INCLUDED

TW-2 CONTROL VALVE (2 LEVER POSITIONS)

	PART NO.	LEVER POSITIONS
	TWD BEN280905N	CENTERING

⚠ WARNING: California Proposition 65 - Cancer and Reproductive Harm - www.P65Warnings.ca.gov.



RELAY VALVES

RG2 - 2 PORT TRAILER VALVE

	PART NO.	DESCRIPTION	SUP. A	SUP. B	DEL. C	DEL. D	CONT POS.	PLUGS INCLUDED	OEM PART NO.
	MBI KN28510	RG2 RELAY VALVE	3/8"	1/2"	3/8"	3/8"	90°	1@1/2"	N30108AK
								1@3/8"	
	MBI KN28520	RG2 RELAY VALVE	1/2"	1/2"	1/2"	1/2"	90°	1@1/2"	N30108BF

⚠ WARNING: California Proposition 65 - Cancer and Reproductive Harm - www.P65Warnings.ca.gov.



RELAY VALVES (continued)

2 PORT WITH INTEGRAL BRACKET

	PART NO.	DESCRIPTION	SUP. (2)	DEL. (2)	CONT (1)	CRACK PRESSURE	REPAIR KIT NO.	OEM PART NO.
	MBI KN28060	RELAY VALVE - TWO PORT - SINGLE CONTROL LINE WITH INTEGRAL BRACKET	1/2"	3/8"	3/8"	4.6 PSI	RN10HK	N30096F

⚠ WARNING: California Proposition 65 - Cancer and Reproductive Harm - www.P65Warnings.ca.gov.

HAND CONTROL VALVES

FLIPPER STYLE - PANEL MOUNT

	PART NO.	DESCRIPTION	RELEASE POSITION	HANDLE FINISH	ALL PORTS	MOUNTING HOLES	OEM PART NO.
 POSITION A →	MBI KN20001	PANEL MOUNT FLIPPER STYLE VALVE	A (SEE PICTURE)	CHROME	1/8"	#10-24 WITH 1.50" CENTERS	N13440DL

DOUBLE FLIPPER STYLE

	PART NO.	DESCRIPTION	APPLY/RELEASE POSITION	SUPPLY PORTS	DELIVERY PORTS	HANDLE NO.	REPAIR KIT NO.	OEM PART NO.
	MBI KN20110	DOUBLE FLIPPER STYLE VALVE	2 POSITION WITH MANUAL RELEASE ONLY	2 @ 1/4" NPT	2 @ 1/8" NPT	K201100	RN34F	N15791J

⚠ WARNING: California Proposition 65 - Cancer and Reproductive Harm - www.P65Warnings.ca.gov.

AIR REGULATING VALVES

AUXILIARY - ADJUSTABLE

	PART NO.	DESCRIPTION	INLET	OUTLET	FACTORY PRESSURE SETTING	OEM PART NO.
	MBI KN31060	ADJUSTABLE AIR REGULATING VALVE FOR AUXILIARY SYSTEMS	1/4" NPT	1/4" NPT	65 PSI	N15817K

⚠ WARNING: California Proposition 65 - Cancer and Reproductive Harm - www.P65Warnings.ca.gov.



TRACTOR PROTECTION VALVES

- Two-Line Manifold Style
- With Exhaust Tube

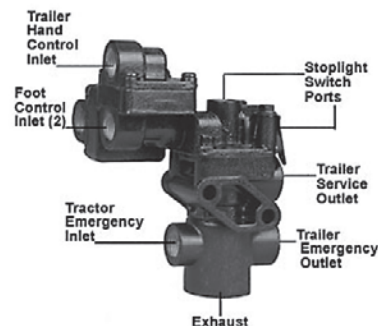

PART NO.	TRAC. EMER. INLET	FOOT CONT.	HAND CONT.	STOP LIGHT SWITCH	TRLR. SERV. OUTLET	TRLR. EMER. OUTLET	OEM PART NO.
MBI KN34110	3/8"	2 @ 3/8" NPT	3/8"	1 @ 1/4"	1/2"	1/2	N30162MA

⚠ WARNING: California Proposition 65 - Cancer and Reproductive Harm - www.P65Warnings.ca.gov.

SOLENOID & ISOLATION AIR VALVES

	PART NO.	DESCRIPTION	ACTUATION VOLTS
	MBI KN68230	SOLENOID AIR VALVE	12 VOLTS

⚠ WARNING: California Proposition 65 - Cancer and Reproductive Harm - www.P65Warnings.ca.gov.

TRAILER VALVES

	PART NO.	DESCRIPTION	CRACK PRESS.	RES.	CONT.	SUP.	SPRING BRAKE	DEL. (4)	OEM PART NO.
	MBI KN28600	FF2 - FULL FUNCTION TRAILER VALVE	3 PSI	3/4"	1/4"	3/8"	2 @ 3/8"	3/8"	N4304AC

⚠ WARNING: California Proposition 65 - Cancer and Reproductive Harm - www.P65Warnings.ca.gov.

AIR BRAKE PARTS



TRAILER VALVES (continued)

RT4 Multi-Function Trailer Valves

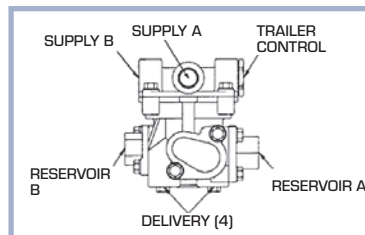

PART NO.	TRAILER SUPPLY (A)	TRAILER SUPPLY (B)	TRAILER CONT.	RES. (A)	RES. (B)	DEL. (4)	PPV CLOSING PRESSURE	OEM PART NO.
MBI KN26020	PLUGGED	3/8"	3/8"	1/2"	3/8"	3/8"	70 PSI	N4305A

⚠ WARNING: California Proposition 65 - Cancer and Reproductive Harm - www.P65Warnings.ca.gov.

EMERGENCY RELAY VALVES



PART NO.	DESCRIPTION	SERV. INLET	EMER. INLET	DEL. (4)	AUX. RES.	RES.	CRACK PRESSURE	REMARKS	OEM PART NO.
MBI KN30400	EMERGENCY RELAY VALVE	1/4"	1/4"	3/8"	PLUGGED	3/4" WITH NIPPLE, FEMALE	3 PSI	CHARGING	N4301CB

⚠ WARNING: California Proposition 65 - Cancer and Reproductive Harm - www.P65Warnings.ca.gov.









LEVELING VALVE KIT

- Linkage included in specified lengths
- One valve can be used for left and right installations; one valve can control two suspension bellows
- Standard flow valve for truck/bus/trailer application

PART NO.	DESCRIPTION
MBI KN27000	EGP STANDARD FLOW LEVELING VALVE KIT, ALL PORTS: 1/4" NPT

⚠ WARNING: California Proposition 65 - Cancer and Reproductive Harm - www.P65Warnings.ca.gov.

AIR VALVES

	PART NO.	DESCRIPTION
	TWD HKN26000	<ul style="list-style-type: none"> RT-4 MULTI-FUNCTION TRAILER VALVE 55 PSI PPV CLOSING PRESSURE, SUPPLY OVER RESERVOIR PORT
	TWD HKN28510	<ul style="list-style-type: none"> RELAY VALVE, 2 DELIVERY 3/8" RESERVOIR A, 1/2" RESERVOIR B, 2 X 3/8" DEL, 6.0 PSI CRACK PRESSURE
	TWD HKN28520	<ul style="list-style-type: none"> RELAY VALVE, 2 DELIVERY 1/2" RESERVOIR A, 1/2" RESERVOIR B, 2 X 1/2" DEL, 6.0 PSI CRACK PRESSURE
	TWD HKN28060	<ul style="list-style-type: none"> RELAY VALVE, 2 DELIVERY 2 X 3/8" DEL, 4.6 PSI CRACK PRESSURE
	TWD HKN28080	<ul style="list-style-type: none"> RELAY VALVE, 4 DELIVERY 4 X 3/8" DEL, 7.0 PSI CRACK PRESSURE
	TWD HKN28600	<ul style="list-style-type: none"> FF-2 FULL-FUNCTION TRAILER VALVE 3/4" NPT RESERVOIR NIPPLE, 3 PSI CRACK PRESSURE
	TWD H401046	<ul style="list-style-type: none"> DRAIN VALVE, 1/4" NPT 5 FOOT CABLE, LOOPED
	TWD H401047	<ul style="list-style-type: none"> DRAIN VALVE, 1/4" NPT 5 FOOT CABLE, PLUS FERRULE

 WARNING: California Proposition 65 - Cancer and Reproductive Harm - www.P65Warnings.ca.gov.



CONTROL VALVES

	PART NO.	DESCRIPTION	NAME PLATE	KNOT	PORT SIZES (NPT)		
					INLET	OUTLET	EXHAUST
	TWD 17600B*	MANUAL PUSH-PULL VALVE (3 HOLE PANEL MOUNTED) * DOLLY AND TRAILER PARK BRAKE RELEASE	826	13	1/4"	1/4"	1/4"

⚠ WARNING: California Proposition 65 - Cancer and Reproductive Harm - www.P65Warnings.ca.gov.



SLOAN AIR ACCESSORY VALVES

PRESSURE PROTECTION VALVES

- Protects primary air source against loss of air pressure downstream.
- Designed for in-tank mounting on tanks with dual outlet ports.



PART NO.	INLET PORTS	OUTLET PORTS	NOM. OPENING PRESSURE	NOM. CLOSING PRESSURE
TWD 401152	3/8 NPTM	3/8 NPTF	55 PSI	45 PSI
TWD 401153	3/8 NPTM	3/8 NPTF	85 PSI	67 PSI
TWD 401155	3/8 NPTM	1/2 NPTF	85 PSI	67 PSI
TWD 401156	1/4 NPTM	1/2 NPTF	100 PSI (MAX.)	70 PSI (MIN.)

RAPID DUMP AIR SUSPENSION VALVE

- Replaces Bendix TR-3, SV-1 and Humphrey 250A N/O valves.
- Pilot operated.
- Rapidly exhausts air from suspension air springs.
- Mounts on frame rails using 1/4" mounting holes.
- Dual delivery design allows for convenient in-line plumbing of air spring lines and eliminates need for tee fittings.

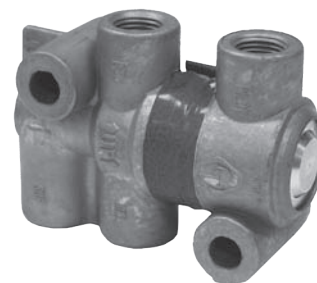

PART NO.	PORT SIZE	MTG. HOLE DIAM.
TWD 401148	(4) 1/8 FPT	1/4

⚠ WARNING: California Proposition 65 - Cancer and Reproductive Harm - www.P65Warnings.ca.gov.



SLOAN AIR ACCESSORY VALVES (CONTINUED)

AIR/AIR-ELECTRIC TOGGLE VALVES

- Used for a variety of air and air-electric applications such as air suspensions, lift axles, fifth wheel sliders and differential locks.
- Push-connect fittings mate easily with 1/4" nylon tubing.
- 150 PSI max. operating pressure.
- Includes all necessary mounting hardware.
- Air-electric switches include a pressure switch and terminals for indicator lamps.



PART NO.	DESCRIPTION	TOGGLE TYPE
TWD 401157	AIR-ELECTRIC 3-WAY TOGGLE VALVE	PADDLE
TWD 401160	AIR 3-WAY TOGGLE VALVE	PADDLE

⚠ WARNING: California Proposition 65 - Cancer and Reproductive Harm - www.P65Warnings.ca.gov.

SLOAN AIR BRAKE VALVES

INLINE QUICK RELEASE VALVES

- Rapidly releases air pressure from trailer brake lines.
- Faster release of trailer service brakes when installed on service side gladhand.
- Quicker application of trailer service brakes when installed on the emergency side gladhand.
- Can be used on double and triple trailers.
- Measures 1.5" diameter x 3.5" long.
- Flow Rate: Forward - 9.0 SCFM at 2 PSI / Exhaust - .0 SCFM at 2 PSI



PART NO.	TRACTOR	TRAILER	DESCRIPTION
TWD 401145	1/2-14 FPT	1/2-14 MPT	MOUNTS BETWEEN TRACTOR PROTECTION VALVE AND AIR LINES
TWD 401146	1/2-14 FPT	1/2-14 MPT	MOUNTS AT TRACTOR GLADHAND

⚠ WARNING: California Proposition 65 - Cancer and Reproductive Harm - www.P65Warnings.ca.gov.



AIR BRAKE VALVES

	PART NO.	DESCRIPTION
	TWD 100132	AIR CYLINDER 3-1/2" I.D. X 8", PUSH-PULL
	TWD 100124	AIR CYLINDER 2-1/2" X 8", PUSH-PULL
	TWD 320121	4 WAY VALVE NON-HOLDING
	TWD 320122	4-WAY VALVE
	TWD 320131	AIR SOLENOID VALVE - 4-WAY, PUSH-PULL

⚠ WARNING: California Proposition 65 - Cancer and Reproductive Harm - www.P65Warnings.ca.gov.



GLADHANDS

SHUT-OFF GLADHANDS W/ STANDARD SEAL

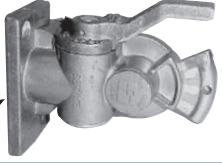
	PART NO.	DESCRIPTION
 <p style="font-size: small; margin-top: 10px;">3/8" - 18 NPTF PORT</p>	TWD 441004	SERVICE
	TWD 441014	EMERGENCY

37-1/2" BRACKET MOUNT GLADHANDS

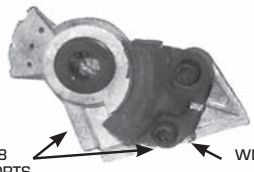
	PART NO.	DESCRIPTION
 <p style="font-size: small; margin-top: 10px;">3/8" - 18 NPTF PORTS WITH PIPE PLUG</p>	TWD 441019	EMERGENCY
	TWD 441023	SERVICE

SWING-AWAY / SHUT-OFF

- Shut-off valve prevents contaminants from entering the system
- Eliminates the need for a dummy coupler
- Decreases plumbing hardware and speeds installation time

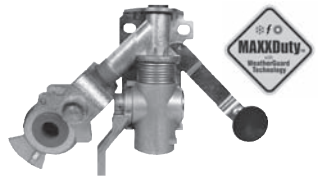
	PART NO.	CONFIGURATION	SEAL TYPE	REMARKS
	TWD 441171	SERVICE	BLACK POLY	CAST ALUMINUM GLADHAND
	TWD 441172	EMERGENCY	BLACK POLY	CAST ALUMINUM GLADHAND

MULTIPLE OTHER SWING-AWAY GLADHANDS (EMERGENCY, ETC.) FROM SLOAN ARE AVAILABLE



STRAIGHT MOUNT

- For use on aircoil, tractor & trailer
- 1/2" pipe port

	PART NO.	DESCRIPTION
	PHI 12-006	SERVICE - BLUE
	PHI 12-008	EMERGENCY - RED
	PHI 12-010	UNIVERSAL

⚠ WARNING: California Proposition 65 - Cancer and Reproductive Harm - www.P65Warnings.ca.gov.

PHILIPS

AIR BRAKE PARTS

GLADHANDS (continued)

ANGLE MOUNT (38°) - BOTTOM PORT

- For use on trailer
- 3/8" pipe port

	PART NO.	DESCRIPTION
	PHI 12-136	SERVICE - BLUE
	PHI 12-138	EMERGENCY - RED

QUICK-E

	PART NO.	DESCRIPTION
	PHI 12-206	FOR USE ON TRAILERS ONLY, 1/2" FEMALE PIPE THREAD WITHOUT FILTER SCREEN

SHUT-OFF GLADHANDS

- Designed for double trailers
- Integrated shut-off valve
- Includes bulk head fitting
- Color coded connector plate for easy identification
- Standard with rubber seal



	PART NO.	DESCRIPTION
	PHI 12-306	SERVICE - BLUE - 1/2" AIR TUBE
	PHI 12-308	EMERGENCY - RED - 3/8" AIR TUBE

COMPOSITE SHUT-OFF GLADHANDS

- Designed for double trailers
- Standard with polyseal
- Composite material for increased protections against magnesium chloride, road salts and chemicals
- Integrated shut-off arm to seal air system
- Molded in-color for easy identification

	PART NO.	DESCRIPTION
	PHI 12-316	SERVICE - 3/8" FEMALE PIPE THREAD
	PHI 12-318	EMERGENCY - 3/8" FEMALE PIPE THREAD

⚠ WARNING: California Proposition 65 - Cancer and Reproductive Harm - www.P65Warnings.ca.gov.

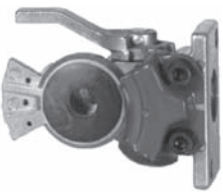
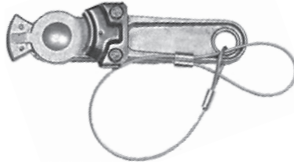
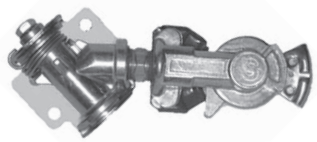
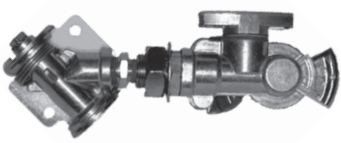
GLADHANDS (continued)		
	PART NO.	DESCRIPTION
	TWD HD12-308	SHUT-OFF GLADHAND EMERGENCY: RED CODED REPLACES: PHILLIPS 12-308, SLOAN 035095
	TWD HD12-306	SHUT-OFF GLADHAND SERVICE: BLUE CODED REPLACES: PHILLIPS 12-306, SLOAN 035094
	TWD HD12-138	38° BRACKET MOUNT GLADHAND EMERGENCY: RED CODED REPLACES: PHILLIPS 12-138, SLOAN 441019
	TWD HD12-136	38° BRACKET MOUNT GLADHAND SERVICE: BLUE CODED REPLACES: PHILLIPS 12-136, SLOAN 441023
	TWD H41014	SERVICE MOUNT WITH SHUT-OFF EMERGENCY: RED CODED REPLACES: SLOAN 441014
	TWD H41004	SERVICE MOUNT WITH SHUT-OFF SERVICE: BLUE CODED REPLACES: SLOAN 441004
	TWD HD120100	"DUMMY" COUPLING 16" CABLE, LOOPE REPLACES: PHILLIPS 12-0100
	TWD HD9222	45° BRACKET MOUNT SWIVEL EMERGENCY: RED CODED REPLACES: TECTRAN 9222
	TWD HD9221	45° BRACKET MOUNT SWIVEL SERVICE: BLUE CODED REPLACES: TECTRAN 9221
	TWD HD9218	45° BRACKET MOUNT SWIVEL WITH SHUT-OFF EMERGENCY: RED CODED REPLACES: TECTRAN 9218
	TWD HD9219	45° BRACKET MOUNT SWIVEL WITH SHUT-OFF SERVICE: BLUE CODED REPLACES: TECTRAN 9219

 WARNING: California Proposition 65 - Cancer and Reproductive Harm - www.P65Warnings.ca.gov.





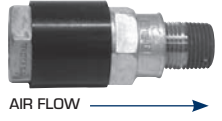

IN-LINE QUICK RELEASE VALVES

- Rapidly releases air pressure from trailer brake lines
- Can be used on double and triple trailers
- Measures 1.5" diameter x 3.5" long
- Flow Rate: Forward - 9.0 SCFM at 2 PSI, Exhaust - 8.0 SCFM at 2 PSI

	PART NO.	DESCRIPTION
	TWD AC197	<ul style="list-style-type: none"> • QUICKER APPLICATION OF TRAILER SERVICE BRAKES WHEN INSTALLED ON THE EMERGENCY, BROWN SLEEVE • REPLACES: 401145, 12-810, 032019, S-C068, 800333, 4000-8
	TWD AC198	<ul style="list-style-type: none"> • FASTER RELEASE OF TRAILER SERVICE BRAKES WHEN INSTALLED ON SERVICE SIDE GLADHAND, BLACK SLEEVE • REPLACES: 401146, 12-811, 032020, 4000-6, 72901-3406, 20-QE-2350



⚠ WARNING: California Proposition 65 - Cancer and Reproductive Harm - www.P65Warnings.ca.gov.

ACCESSORIES

GLADHAND SEALS					
	PART NO.	DESCRIPTION		PART NO.	DESCRIPTION
	TWD H12012	WIDE LIP, RUBBER		TWD H41737-S	RED POLYURETHANE, SURFACE SEALING, WITH SCREEN
	TWD H41736	BLACK, CLOSED, RUBBER		TWD H41738-S	BLUE, POLYURETHANE, SURFACE SEALING, WITH SCREEN
	TWD H41737	RED, POLYURETHANE		TWD H41738-BRS	SET OF 2 BLUE & 2 RED POLYURETHANE, SURFACE SEALING, WITH 4 SCREENS
	TWD H41738	BLUE, POLYURETHANE			

⚠ WARNING: California Proposition 65 - Cancer and Reproductive Harm - www.P65Warnings.ca.gov.





ACCESSORIES (continued)		
GLADHAND GRIPS		
	PART NO.	DESCRIPTION
	TWD H41751	GLADHAND GRIP HANDLES <ul style="list-style-type: none"> • EASY TO INSTALL 2-PIECE RED & BLUE COLOR • 1/2" NPT MALE GLADHAND & 1/2" FEMALE AIRLINE • REPLACES: SLOAN 441751
	TWD HD12-600	GLADHAND GRIP EXTENSIONS <ul style="list-style-type: none"> • 1-PIECE DESIGN, MADE FROM SOLID ALUMINUM • RED & BLUE ANODIZED • 1/2" NPT MALE & FEMALE THREADS, WITH THREAD • REPLACES: PHILLIPS 12-600



	PART NO.	DESCRIPTION
	TWD 441751	GLADHAND DURA-GRIP SET 1/2" NPTF FEMALE AIRLINE
		GLADHAND DURA-GRIP SET 1/2" NPTF MALE GLADHAND

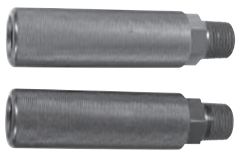

	PART NO.	DESCRIPTION
	PHI 12-600	COILED AIR GRIPS PAIR (RED & BLUE), CLAMSHELL, PROVIDES STRONG LEVERAGE FOR COUPLING/ UNCOUPLING GLADHANDS

 WARNING: California Proposition 65 - Cancer and Reproductive Harm - www.P65Warnings.ca.gov.

PHILIPS

ACCESSORIES (continued)

TWO GLADHAND HOLDER

	PART NO.	DESCRIPTION
	PHI 15-042	STOW-A-WAY™ 2 PLUG

POGO STICKS

- Designed for use with heavier ABS cables
- Can accept STOW-A-WAY™ (15-041, 15-042), needs 17-039 mounting kit
- Includes QWIK-SNAP™ 3-hose holder
- Heavy-duty 7/16" mounting bolt
- Extra heavy-duty internal spring
- 8" coated spring for corrosion resistance

	PART NO.	DESCRIPTION
	PHI 17-0240	24" CHROME
	PHI 17-0400	40" CHROME
	PHI 17-0401	40" GOLD CHROME

TRACKER BAR REPLACEMENT PART KITS

- Replacement spring and hardware for tracker bars
- Kit includes snap-on clip, sleeve, 3-hose holder and spring

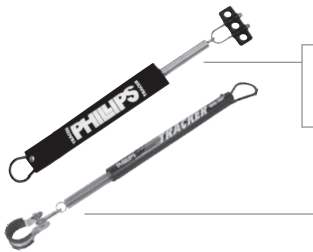
	PART NO.	DESCRIPTION
	PHI 17-148	KIT, 20" SPRING
	PHI 17-420	KIT, TWO 16" SPRINGS
	PHI 17-1488	KIT, 20.5" EXTRA HEAVY-DUTY SPRING KIT WITH CABLE CLAMP HOLDER, DURABLE PVC SLEEVE FOR PROTECTION

PHILLIPS GLADHAND SEALS

	PART NO.	DESCRIPTION
	PHI 12-0161	BLUE, POLYURETHANE
	PHI 12-0162	RED, POLYURETHANE
	PHI 12-0163	BLACK, POLYURETHANE
	PHI 12-0164	2 RED/2 BLUE, POLYURETHANE

⚠ WARNING: California Proposition 65 - Cancer and Reproductive Harm - www.P65Warnings.ca.gov.



ACCESSORIES (continued)

GLADHAND FILTER SCREENS

	PART NO.	DESCRIPTION
	PHI 12-038	FITS GLADHAND PART NO. 12-006, 12-008, 12-010, 12-136, 12-138
	PHI 12-039	FITS QWIK-E® GLADHAND PART NO. 12-206, 12-236



HALDEX GLADHAND SEALS

	PART NO.	DESCRIPTION
	MBI DA909005	4 PACK (2 RED/2 BLUE)

COUPLERS WITH CHAIN

- Zinc and yellow dichromate bodies with chain attached
- Available with and without vent hole

	PART NO.	OEM	DESCRIPTION
	MBI 11401	N13048A	WITH VENT
	MBI 11402	N13048	WITHOUT VENT

⚠ WARNING: California Proposition 65 - Cancer and Reproductive Harm - www.P65Warnings.ca.gov.

PHILIPS

AIR BRAKE PARTS

POLAR AIR® AIR BRAKE COILS

- Perfect for extreme weather conditions : Remains flexible at -85°F (-65°C)
- Excellent ratings for recoil memory, chemical resistance & abrasion resistance
- Features POWER GRIP™ which provides superior coupling/uncoupling leverage

	PART NO.	DESCRIPTION	WORKING LENGTH*
	PHI 11-5150	PAIR (RED & BLUE)	15'
	PHI 11-5400	PAIR (RED & BLUE)	15' W/ 40" LEAD
	PHI 11-5200	PAIR (RED & BLUE)	20'

⚠ WARNING: California Proposition 65 - Cancer and Reproductive Harm - www.P65Warnings.ca.gov.

COILED AIR WITH GLADHANDS

	PART NO.	DESCRIPTION	WORKING LENGTH*
	PHI 11-3159	PAIR, WITH 2 GLADHANDS	15'
	PHI 11-31509	POWER GRIP™ PAIR, WITH 2 GLADHANDS	15'
	PHI 11-3409	PAIR, WITH 2 GLADHANDS	15' W/ 40" LEAD

⚠ WARNING: California Proposition 65 - Cancer and Reproductive Harm - www.P65Warnings.ca.gov.

RUBBER AIR HOSES

	PART NO.	DESCRIPTION
	PHI 11-8112	AIR LINE RUBBER 12 FT SET
	PHI 11-8115	AIR LINE RUBBER 15 FT SET
	PHI 11-8120	AIR LINE RUBBER 20 FT SET

*Working Length as measured by pull force per SAE J2222; length of actual cable is significantly longer

⚠ WARNING: California Proposition 65 - Cancer and Reproductive Harm - www.P65Warnings.ca.gov.



COILED AIR HOSES

- Coiled hoses are oil and chemical resistant and are able to withstand harsh weather and environmental conditions
- Tightly coiled to minimize kinking and sagging
- Working pressure of 150 PSI
- Operating temperature of -40°F to 220°F



PART NO.	LENGTH	COLOR	PACK
GRO 81-0015	15'	RED AND BLUE	2
GRO 81-0015-R	15'	RED	1
GRO 81-0015-B	15'	BLUE	1
GRO 81-0015-40	15' WITH 40" LEADS	RED AND BLUE	2
GRO 81-0015-40R	15' WITH 40" LEADS	RED	1
GRO 81-0015-40B	15' WITH 40" LEADS	BLUE	1

LOW TEMPERATURE COILED AIR HOSES

- Operating temperature of -65°C (-85°F) to 104°C (220°F)
- Includes a swivel fitting for the tractor-end connection
- Brass handle enables a solid grip for coupling/uncoupling hoses
- Double-jacketed coils remain flexible in extremely cold temperatures



PART NO.	LENGTH	COLOR	PACK
GRO 81-0012-C	12' WITH LEADS 6"	RED AND BLUE	2
GRO 81-0015-C	15' WITH LEADS 12"	RED AND BLUE	2
GRO 81-0015-40C	15' WITH LEADS 12" & 40"	RED AND BLUE	2
GRO 81-0020-C	20' WITH LEADS 12"	RED AND BLUE	2



AIR BRAKE HOSES - BULK

	PART NO.	LENGTH	I.D.	O.D.
	TWD 451028	250'	3/8"	3/4"
	TWD 451044	250'	1/2"	7/8"
	TWD 451063	100'	1/2"	7/8"

ADDITIONAL LENGTHS AVAILABLE UPON REQUEST

⚠ WARNING: California Proposition 65 - Cancer and Reproductive Harm - www.P65Warnings.ca.gov.



COILED AIR HOSES (continued)

3-IN-1 WRAP

- Service & Emergency Air Line
- ABS Power Cord
- Dura-Grip Handles

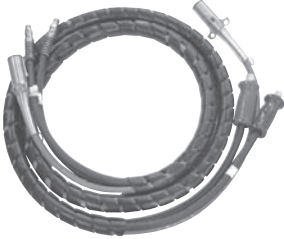
	PART NO.	LENGTH	DESCRIPTION
	TWD 451097	12'	(1) 7-WAY ABS W/ METAL PLUGS, (2) 3/8" RUBBER AIR LINES W/COLOR CODED DURA-GRIPS
	TWD 451098	15'	(1) 7-WAY ABS W/ METAL PLUGS, (2) 3/8" RUBBER AIR LINES W/COLOR CODED DURA-GRIPS
	TWD 451099	20'	(1) 7-WAY ABS W/ METAL PLUGS, (2) 3/8" RUBBER AIR LINES W/COLOR CODED DURA-GRIPS
	TWD 451106	100'	BLACK WRAP

⚠ WARNING: California Proposition 65 - Cancer and Reproductive Harm - www.P65Warnings.ca.gov.

NYLON AIR BRAKE TUBING - BULK

	PART NO.	LENGTH	O.D.	COLOR
	TWD 451030	100'	1/4"	BLACK
	TWD 451031	100'	3/8"	BLACK
	TWD 451031B	100'	3/8"	BLUE
	TWD 451031G	100'	3/8"	GREEN
	TWD 451031R	100'	3/8"	RED
	TWD 451032	100'	1/2"	BLACK
	TWD 451032R	100'	1/2"	RED
	TWD 451033	50'	5/8"	BLACK
	TWD 451034	50'	3/4"	BLACK

⚠ WARNING: California Proposition 65 - Cancer and Reproductive Harm - www.P65Warnings.ca.gov.



TENDER SPRINGS

	PART NO.	DESCRIPTION
	PHI 17-111	11" HEAVY DUTY TENDER SPRING
	PHI 17-116	16" HEAVY DUTY TENDER SPRING
	PHI 17-120	20" HEAVY DUTY TENDER SPRING
	PHI 17-125	25" HEAVY DUTY TENDER SPRING

⚠ WARNING: California Proposition 65 - Cancer and Reproductive Harm - www.P65Warnings.ca.gov.



AIR HOSE HOLDERS & SEPARATORS

	PART NO.	DESCRIPTION
	TWD H51001	HOLDER, TWO 3/4" HOLES FOR 3/8" I.D. AIR LINES
	TWD H51009	HOLDER, TWO 3/4" HOLES FOR 3/8" I.D. AIR LINES; CENTER HOLE FOR 7-CONDUCTOR ELECTRICAL CABLE
	TWD H51037	SEPARATOR, FOR 3/8" AIR HOSES
	TWD H51038	SEPARATOR, FOR 1/2" AIR HOSES

⚠ WARNING: California Proposition 65 - Cancer and Reproductive Harm - www.P65Warnings.ca.gov.





D

SUSPENSION

AIR SUSPENSION VALVES & COMPONENTS	132-152
AIR CONTROL BOXES	153-155
TRAILER SUSPENSION	156-162
TRUCK SUSPENSION	162-167
MISCELLANEOUS SUSPENSION PARTS	167
HEAVY-DUTY SHOCKS	168-169
AIR SPRINGS	170-181



D

SUSPENSION

HEIGHT CONTROL VALVES

	PART NO.	DESCRIPTION
	TWD H00450CE	HCV FOR CAB, CHASSIS OR TRAILER <ul style="list-style-type: none"> • INTEGRATED CHECK VALVE • PORTS ALLOW FOR FOUR DIFFERENT POSITIONS • DESIGN PROTECTS AGAINST TAMPERING • INCLUDES INSTALLATION BRACKET
	TWD H00600P	HCV FOR CAB OR LIGHT DUTY CHASSIS APPLICATIONS <ul style="list-style-type: none"> • ALLOWS SUSPENSION TO MAINTAIN THE MANUFACTURERS SET RIDE HEIGHT • INTEGRATED DUMP VALVE • COMPATIBLE WITH TRACTOR & TRAILER APPLICATIONS • HIGHEST AIR FLOW IN THE INDUSTRY • LOW AIR CONSUMPTION • THREADED PORTS OPTIONS AVAILABLE • INCLUDES INSTALLATION BRACKETS • ONE LEVER • LINKAGE INCLUDED - HPB450H

NEXT GENERATION HCV UNIVERSAL KITS

	<ul style="list-style-type: none"> • Lightweight construction, highly durable and proven components • Modular design for varying Truck, Trailer, RV and Agricultural App's • Repeatability • Variable Flow Rate - Fast off the bumpers, minimal air consumption during normal operation 			
	PART NO.	SUPPLY PORT (PTC)	SUSPENSION PORT (PTC)	DUMP PORT (PTC)
	TWD H01500UN	3/8"	3/8"	-
	TWD H01501PUD	1/4"	1/4"	1/4"
TWD H01501UD	3/8"	3/8"	1/4"	

⚠ WARNING: California Proposition 65 - Cancer and Reproductive Harm - www.P65Warnings.ca.gov.

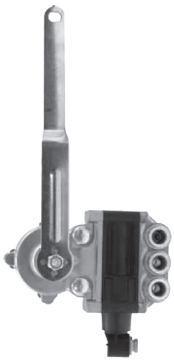
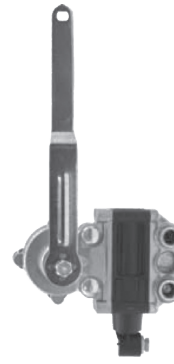
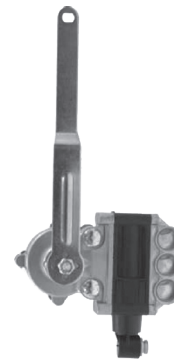

VOLVO - MACK REPLACEMENT PR VALVES

	PART NO.	DESCRIPTION	REPLACEMENT PARTS		
			VOLVO	MACK	HALDEX
	MBI 90555353	<ul style="list-style-type: none"> • 7" ARM • NORMALLY OPEN DUMP • 5 PORT 3/8" PTC SIDE MANIFOLD CAN BE USED INSTEAD OF 90555263 BY PLUGGING 2 DELIVERY PORTS 	21126541	N/A	90555355 90555254
			20908571		
			20788736 OLD		
			85112623		
			85108667		
	MBI 90555263	<ul style="list-style-type: none"> • 7" ARM • NORMALLY OPEN DUMP • REPLACEMENT BRACKET • 3 PORT 3/8" PTC SIDE MANIFOLD 	21126543	99QK418M	90555356 90555262
			20908582		
			2033734 OLD	5396-90555263	
			85109873		
	MBI 90555318	<ul style="list-style-type: none"> • 7" ARM • NORMALLY OPEN DUMP • 3 PORT 3/8" PTC SIDE MANIFOLD WITH PORTS ON BACK SIDE OF VALVE 	20839693	99QK55AM	90555357
				99QK55M	90555268
			20888298	99QK56M	90555289
				20839691	99QK54AM
			99QK54M		90555271
			N/A	5396-90555318	N/A

D

SUSPENSION

⚠ WARNING: California Proposition 65 - Cancer and Reproductive Harm - www.P65Warnings.ca.gov.



KENWORTH REPLACEMENT PR VALVES

D

SUSPENSION

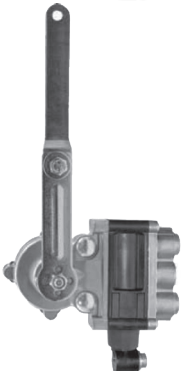
	PART NO.	DESCRIPTION	REPLACEMENT PARTS	
			KENWORTH	HALDEX
	MBI 90555375	<ul style="list-style-type: none"> • 7" ADJUSTABLE ARM • NORMALLY OPEN DUMP • 3 PORT 3/8" PTC SIDE MANIFOLD 	G90-1099-024	90555121
			G90-1073-024	
			G90-1099-026	90555119
			G90-1073-026	
			G90-1099-095	90555141
			G90-1073-095	
	MBI 90555376	<ul style="list-style-type: none"> • 7" ADJUSTABLE ARM • NORMALLY OPEN DUMP • 2 PORT 3/8" PTC STRAIGHT MANIFOLD 	G90-1099-007	90555126
			G90-1073-007	
			G90-1099-008	90555127
			G90-1073-008	
			G90-1099-011	90555130
			G90-1073-011	
			G90-1099-012	90555131
			G90-1077-012	
			G90-1099-097	90555143
G90-1073-097				

⚠ WARNING: California Proposition 65 - Cancer and Reproductive Harm - www.P65Warnings.ca.gov.

UNIVERSAL PR VALVES

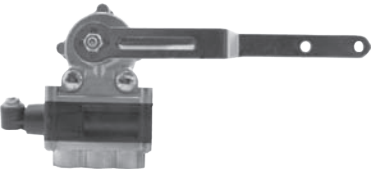
	PART NO.	DESCRIPTION
	MBI 90555335	<ul style="list-style-type: none"> • REPLACES MOST BARKSDALE AND HADLEY VALVE INSTALLATIONS • FOR TRAILERS, CAB AND FRONT AXLE INSTALLATIONS • FOR 1/4" NPT PORTS
	MBI 90555108	<ul style="list-style-type: none"> • 7" ADJUSTABLE ARM • WITH NORMALLY CLOSED DUMP • 3 PORT 1/4" NPT STRAIGHT MANIFOLD • FOR TRAILER SUSPENSION APPLICATIONS

⚠ WARNING: California Proposition 65 - Cancer and Reproductive Harm - www.P65Warnings.ca.gov.



EGP HEIGHT CONTROL VALVE

NORTH AMERICAN VERSION IN THE EGP VALVE FAMILY

- Dual or single circuit operation without extra ports or fittings
- High grade durable all plastic construction for corrosion protection
- Optional dump valve available
- 1/4" NPT fittings



MBI 90555105

D

SUSPENSION

PART NO.	DESCRIPTION
MBI KN27000	STANDARD FLOW WITH 14" LEVER
MBI KN27013	HIGH FLOW WITH 14" LEVER ARM
MBI KN27201	LOW FLOW (VALVE ONLY)
MBI 90555105	STANDARD FLOW (VALVE ONLY)

⚠ WARNING: California Proposition 65 - Cancer and Reproductive Harm - www.P65Warnings.ca.gov.

ADJUSTABLE LINKAGE

	PART NO.	DESCRIPTION
	MBI 48100225	<ul style="list-style-type: none"> • A COMMON TRAILER SUSPENSION LINKAGE USED BY SEVERAL OE MANUFACTURERS. • LINKAGE CAN BE CUT TO OBTAIN DESIRED LENGTH (19" MAXIMUM). • SIMPLE TO ASSEMBLE AND INSTALL.

⚠ WARNING: California Proposition 65 - Cancer and Reproductive Harm - www.P65Warnings.ca.gov.



D

SUSPENSION

ADJUSTABLE LOOPED LINKAGE

	PART NO.	DESCRIPTION
	MBI 48100374	<ul style="list-style-type: none"> • COMMON TRUCK/TRAILER SUSPENSION USED BY SEVERAL OE MANUFACTURERS. • ADJUSTABLE LINK END ALLOWS FOR EASY INSTALLATION. • FIXED LOOPED END PROVIDES DURABILITY. • LINKAGE CAN BE CUT TO OBTAIN DESIRED LENGTH (16" MAXIMUM).
	MBI 48100375	<ul style="list-style-type: none"> • COMMON TRUCK/TRAILER SUSPENSION USED BY SEVERAL OE MANUFACTURERS. • ADJUSTABLE LINK END ALLOWS FOR EASY INSTALLATION. • FIXED LOOPED END PROVIDES DURABILITY. • LINKAGE CAN BE CUT TO OBTAIN DESIRED LENGTH (22" MAXIMUM).

⚠ WARNING: California Proposition 65 - Cancer and Reproductive Harm - www.P65Warnings.ca.gov.

ADJUSTABLE STRAP LINKAGE



	PART NO.	DESCRIPTION
	MBI 48100367	<ul style="list-style-type: none"> • A COMMON TRAILER SUSPENSION LINKAGE USED BY SEVERAL OE MANUFACTURERS. • LINKAGE CAN BE WELDED AT DESIRED LENGTH TO AVOID FIELD ADJUSTMENT ISSUES (14" MAXIMUM).

⚠ WARNING: California Proposition 65 - Cancer and Reproductive Harm - www.P65Warnings.ca.gov.

ILAS® III

Fully pneumatic lift axle control valve - Manual and automatic versions provide flexibility with any lift axle application.

- ILAS®III (Integrated Lift-Axle System) provides precise operation of lift axles for commercial vehicles and trailers
- Manual version automatically lowers lift axle; lift axle is manually raised
- Automatic version automatically lowers and lifts the lift axle
- Integrated mounting holes and solid structure allow for easy installation
- ILAS®III replaces many lift axle systems which typically require multiple components and fittings
- Fitting Kit RN21BA (includes five threaded PTC fittings)

	PART NO.	DESCRIPTION
	MBI 90555426	ILAS®III AUTOMATIC
	MBI 90555425	ILAS®III MANUAL

⚠ WARNING: California Proposition 65 - Cancer and Reproductive Harm - www.P65Warnings.ca.gov.

HEIGHT CONTROL VALVES (continued)

- Immediate response height control air valve
- Increases and decreases air flow to air suspension, preserving appropriate vehicle height
- Left or right installation
- No time delay
- Adjusts air pressure under varying weather and payload conditions

D

SUSPENSION

	PART NO.	REPLACES	SUPPLY	AIR SPRING
<p>Air Spring</p>	TWD AC001	NEWAY/HALDEX: 90554241	1/4" NPT	1/4" NPT
	TWD AC001D	NEWAY/HALDEX: 90054271	1/4" NPT	1/4" NPT
NOTES				
DISCHARGE RELEASED THROUGH DUMP VALVE. NORMALLY OPEN, NEEDS AIR PRESSURE TO DUMP.				

- Dump valve to use with AC001
- Must remove head diaphragm when used as a retrofit
- Normally open, needs air pressure to dump

	PART NO.	REPLACES	SUPPLY	AIR SPRING
	TWD AC201	NONE	1/4" NPT	1/4" NPT

⚠ WARNING: California Proposition 65 - Cancer and Reproductive Harm - www.P65Warnings.ca.gov.



HEIGHT CONTROL VALVES (continued)

D

SUSPENSION

- Height control air valve
- Increases and decreases air flow to suspension, preserving vehicle height

	PART NO.	REPLACES	SUPPLY	AIR SPRING
	TWD AC002D	NEWAY/HALDEX: 90554334	1/8" NPT	1/8" NPT
NOTES				
NORMALLY OPEN, NEEDS AIR PRESSURE TO DUMP.				

- Dump valve to use with AC002
- Normally open, needs air pressure to dump
- Connect to valve air spring port

	PART NO.	REPLACES	SUPPLY	AIR SPRING
	TWD AC202	NEWAY/HALDEX: 90554335	1/8" NPT	1/8" NPT

⚠ WARNING: California Proposition 65 - Cancer and Reproductive Harm - www.P65Warnings.ca.gov.



HEIGHT CONTROL VALVES (continued)

- Universal / Truck / Tractor / Trailer
- Integrated dump valve

	PART NO.	REPLACES	SUPPLY	DELIVERY	AIR SPRING
	TWD 60501-000	BARKSDALE: 52341-Q123 KD2360	1/4" NPT	1/4" NPT	1/4" NPT

⚠ WARNING: California Proposition 65 - Cancer and Reproductive Harm - www.P65Warnings.ca.gov.

BARKSDALE STYLE REPLACEMENT VALVES

- Fast Response, High Airflow Design
- 5 X 1/4" Ports
- Integral Dump Valve for 52341 Style

D

SUSPENSION

	PART NO.	DESCRIPTION
	TWD HD52341-Q2205	<ul style="list-style-type: none"> • COMPATIBLE WITH: BARKSDALE KD2205 FREIGHTLINER 16-14318-000 VOLVO 3188710 • ARM OVERALL LENGTH: 8-3/4" • ARM DROP: 5/8" • 2 X LINK HOLES • NORMALLY CLOSED
	TWD HD52321-Q29	<ul style="list-style-type: none"> • REPLACES: BARKSDALE 52321-Q29, Q113, Q197, FREIGHTLINER KD2204 • FOR SCHOOL BUS
	TWD HD52341-Q206	<ul style="list-style-type: none"> • REPLACES: BARKSDALE KD2360, HADLEY HAD500NS, INTERNATIONAL 2506169C91 • NORMALLY CLOSED

⚠ WARNING: California Proposition 65 - Cancer and Reproductive Harm - www.P65Warnings.ca.gov.



D

SUSPENSION

LINKAGE KITS

- Use with ACOO2 controlled response height control valve
- For all time-delay height applications
- Maximum height up to 19-5/8"

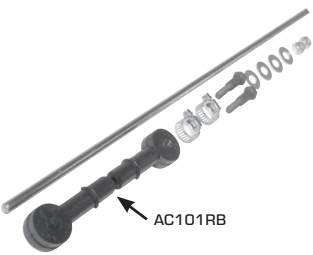
	PART NO.	REPLACES	KIT INCLUDES	
			QTY	DESCRIPTION
 <p>AC101RB</p>	TWD AC101	NEWAY: SRK168	2	BOLT
			1	LINKAGE ROD
			2	NUT
			2	RUBBER ROD END (AC101RB)
			2	STEEL CLAMPS
			4	WASHER

- Universal trailer linkage kit
- Maximum height up to 14"

	PART NO.	REPLACES	KIT INCLUDES	
			QTY	DESCRIPTION
	TWD AC103	HENDRICKSON: A14187 MANAL: 073-060 TECTRAN: 80-1006AL	2	10-24 (UNC) THRD. X 1/2" LG. BOLT
			2	10-24 (UNC) THRD. LOCK NUT
			2	1/4"-20 (UNC) THRD. X 1-1/2" BOLT
			2	1/4"-20 (UNC) THRD. LOCK NUT
			2	1/4" I.D. FLAT WASHER
			2	8" LG. LINK ASSEMBLY

 WARNING: California Proposition 65 - Cancer and Reproductive Harm - www.P65Warnings.ca.gov.

PILOT VALVES

- Multi-function pilot valve
- Base-mounted three-way valve
- Air piloted from 20 to 125 PSI
- Pressure actuated
- Normally closed and normally open pilot valve exhausts air from air suspensions
- Not intended for brake system, but is commonly used for service line override on lift axles

	PART NO.	REPLACES	PORTS	PILOT
	TWD AC005NC	NEWAY: 90054079	1/4" NPT	1/8" NPT

- Three-way relay normally open valve designed for cold weather use
- Pilot control pressure at 5-10 PSI to open, 10-30 PSI to close
- Maximum input pressure 150 PSI

	PART NO.	REPLACES	INLET	CONTROL	OUTLET
	TWD AC019 NORMALLY OPEN	NEWAY: 90054206 WILLIAMS: 111542, WM147P	1/4" NPT	1/8" NPT	1/4" NPT
	TWD AC026 NORMALLY OPEN	WILLIAMS: 111531 WM147F	1/4" NPT	1/8" NPT	1/4" NPT

- Three-way normally closed valve
- Pilot control pressure at 15-30 PSI to open valve
- Maximum input pressure 150 PSI

	PART NO.	REPLACES	INLET	CONTROL	OUTLET
	TWD AC027 NORMALLY CLOSED	NEWAY: 90054205 WILLIAMS: 111527, WM147C	1/4" NPT	1/4" NPT	1/4" NPT

⚠ WARNING: California Proposition 65 - Cancer and Reproductive Harm - www.P65Warnings.ca.gov.



D

SUSPENSION

SOLENOID VALVES

- Three-way electric solenoid valve • Activates when energized
- 12 volt solenoid valve delivers pressure to port via an electrical signal

	PART NO.	REPLACES	A	B
	TWD AC003	NORMALLY CLOSED, OPEN WHEN ENCORED NEWAY: 90054074 PETER PAUL: 23JJ9ZCV TECTRAN: 80-1074SS	1/4" NPT	1/4" NPT

- Three-way electric solenoid valve • Closes when energized
- Normally open 12 volt solenoid valve delivers pressure to port via an electrical signal

	PART NO.	REPLACES	A	B
	TWD AC004	NORMALLY OPEN, CLOSES WHEN ENCORED NEWAY: 90054075 PETER PAUL: 24JJ9ZCV TECTRAN: 80-1075SS	1/4" NPT	1/4" NPT

- Replacement solenoid • Normally closed and normally open
- Multi-function can close or open when energized

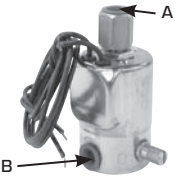
	PART NO.	REPLACES	A	B
	TWD AC074	PETER PAUL: 26JJ9YZGV TECTRAN: 80-1076 NEWAY: 90054076	1/4" NPT	1/4" NPT

- Electric solenoid air valve • Grounds through bracket
- Normally closed, operated electrically with an "on-off" switch, operated to deliver air through one port in the "on" position
- Max Operating Pressure: 130 PSI, Standard Operating Pressure: 125 PSI

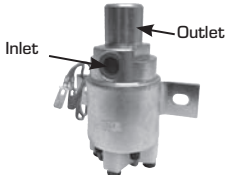
	PART NO.	PORTS
	TWD AC075	1/4" NPTF

⚠ WARNING: California Proposition 65 - Cancer and Reproductive Harm - www.P65Warnings.ca.gov.

SOLENOID VALVES (continued)

- Schrader valvair series
- Designed for fast response & durability
- Electric control or manual combination valve

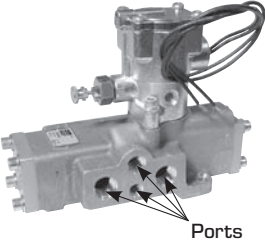
	PART NO.	REPLACES
	TWD AC015CAP	END COVER REPAIR KIT, INCLUDES AIR FILTER & END GASKET
	TWD AC015MG	REPLACEMENT METAL GASKET
	TWD AC015K	AC015 REPAIR KIT



- Replacement solenoid
- Includes manual locking override

	PART NO.	REPLACES
	TWD AC033	HENDRICKSON: A-12502-031 SCHRADER: K085W02545 TECTRAN: 27K853025
	TWD AC033K	AC033 REPAIR KIT

⚠ WARNING: California Proposition 65 - Cancer and Reproductive Harm - www.P65Warnings.ca.gov.

AIR CONTROL VALVES

- All Weather Performance
- Compact – 30 to 40% Smaller & Lighter
- All Connection 3/8" Dot Push-to-Connect

	PART NO.	DESCRIPTION
	TWD AC194	WITH AIR RESET PORT REPLACES ALKON: TDB-0045
	TWD AC196	FULLY MANUAL REPLACES ALKON: TDB-0048, AK12403N

⚠ WARNING: California Proposition 65 - Cancer and Reproductive Harm - www.P65Warnings.ca.gov.



AIR CONTROL VALVES (continued)

- Two-position, five-port valve for lift axle applications
- Externally piloted
- 12 volt solenoid actuator & manual locking override knob
- Operates manually or electric
- Used in AC225 & AC225SS

D

SUSPENSION

	PART NO.	REPLACES	PORTS
	TWD AC045 GENUINE	NEWAY: 90554662 NORGREN: K910019 TECTRAN: 29SS6E	3/8" NPT

* Replacement Coil Cables on Page 144

- Electric control valve - 2 positions

	PART NO.	REPLACES	PORTS	PILOT
	TWD AC090	NORGREN: K71EA00KS6KVW	5 PORTS (3/8" NPT)	PILOT PRESSURE 35 - 150 LBS 1/8 PTF EXTERNAL AIR OPERATOR PILOT
	TWD AC091	NORGREN: K71EA00KS6KV2	5 PORTS (3/8" NPT)	WITH LOCKING OVERRIDE KNOB, PILOT PRESSURE 35 - 150 LBS
	TWD AC091S	REPLACEMENT ACTUATOR		

- Solenoid, 4-way, 2-position
- 12V DC

	PART NO.	REPLACES	PORTS
	TWD AC195	BUYERS: BAV050SA	5-PORTS (1/4" NPT)

⚠ WARNING: California Proposition 65 - Cancer and Reproductive Harm - www.P65Warnings.ca.gov.

AIR CONTROL VALVES (continued)

- Two-position, three-port replacement valve
- External air pilot supply & spring return

	PART NO.	REPLACES	PORTS
	TWD AC038R	MANAC: 023-2995 NORGREN: K41EA00KS6KA2	3/8" NPT

- Two-position, five-port valve
- External air pilot supply & spring return

	PART NO.	REPLACES	PORTS
	TWD AC044R	NORGREN: K71EA00KS6KA2	3/8" NPT

- Two-position, three-port valve
- Manual return

	PART NO.	REPLACES	PORTS
	TWD AC043R	MANAC: 023-2996 NORGREN: K910038 PARKER/SHRADER: M08531826	3/8" NPT USE WITH AC048N FOR DASH MOUNT

⚠ WARNING: California Proposition 65 - Cancer and Reproductive Harm - www.P65Warnings.ca.gov.



AIR CONTROL VALVES (continued)

- Two-position, three-port valve • Air pilot return

D

SUSPENSION

	PART NO.	REPLACES	PORTS
	TWD AC048R	AIRMAX: D2400188 MANAC: 223-6195 NORGREN: K910054	3/8" NPT USE WITH AC048N FOR DASH MOUNT

AC085: Two-position, five-port valve. Valve operates any double action cylinder.

AC097: Three-position, five-port valve. Holding Type.

	PART NO.	REPLACES	PORTS
	TWD AC085	VELVAC: 320121, 320107	1/4" - 18 FPT

- Three-position, five-port valve • Center position to block air & exhaust cylinder

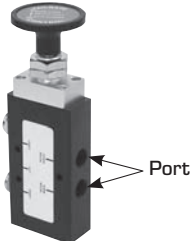
	PART NO.	REPLACES	PORTS
	TWD AC088	BUYERS: BAV020	1/4" - 18 FPT

- Two-position, five-port hand valve • Button operated, manual return

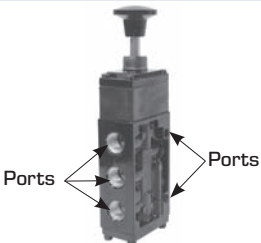
	PART NO.	REPLACES	PORTS
	TWD AC060	PARKER: 52043-1000	3/8" NPT

⚠ WARNING: California Proposition 65 - Cancer and Reproductive Harm - www.P65Warnings.ca.gov.

AIR CONTROL VALVES (continued)

- Two-position, five-port hand valve • Button operated, manual operation, pilot return

	PART NO.	REPLACES	PORTS	PILOT
	TWD AC061	PARKER: 52045-1000	3/8" NPT	1/8" NPT

- Two-position, five-port hand valve • Button operated, spring return

	PART NO.	REPLACES	PORTS
	TWD AC064	PARKER: 52041-1000	3/8" NPT

- Two-position, three-port valve • Manual return
- Specially designed for tailgate cylinder applications

	PART NO.	REPLACES	PORTS
	TWD AC092	AIR KING: HAG108 APSCO: V-8	1/4" NPT

- Quick-draw auto reset valve • Three-way, two-position • Breather fitting included

	PART NO.	REPLACES	PORTS
	TWD AC087	HENDRICKSON: VS-25223	1/4" NPT

⚠ WARNING: California Proposition 65 - Cancer and Reproductive Harm - www.P65Warnings.ca.gov.



D

SUSPENSION

CHECK VALVES

- One-way check valve
- Remains normally closed until it reaches a pressure of 75 PSI
- Protects air brake system from accessory leak and/or failure

	PART NO.	REPLACES	A
	TWD AC007	MANAC: 023-290 NEWAY: 90554107	1/4" NPT

- One-way check valve
- Protects air brake system from accessory leak and/or failure
- Remains normally closed until it reaches a pressure of 70 PSI with a maximum operating pressure of 150 PSI

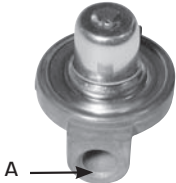
	PART NO.	REPLACES	A
	TWD AC008	MANAC: 023-150 WILLIAMS: 118181	1/4" NPT

- One-way check valve
- Remains normally closed until it reaches a pressure of 75 PSI
- Protects air brake system from accessory leak and/or failure

	PART NO.	REPLACES	A	B
	TWD AC028	HENDRICKSON: A14149	3/8" NPT	1/2" NPT

⚠ WARNING: California Proposition 65 - Cancer and Reproductive Harm - www.P65Warnings.ca.gov.

PRESSURE REGULATORS

- Manually adjustable pressure regulator valve which reduces incoming pressure in the 50-120 PSI range to a lower pressure
- Maximum input pressure 250 PSI and a regulating range 2-125 PSI
- Bracket mount included

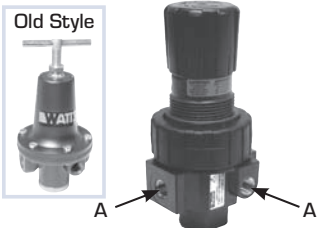
	PART NO.	REPLACES	A
	TWD AC010	GRANNING: 1287 HENDRICKSON: A12502-014 MANAC: 023-301 NEWAY: 90054077 PARKER: 06R113AA TECTRAN: 80-1077	1/4" NPT

- Miniature pressure regulator comes with locking knob
- Maximum input pressure 300 PSI • Regulating range 5-125 PSI

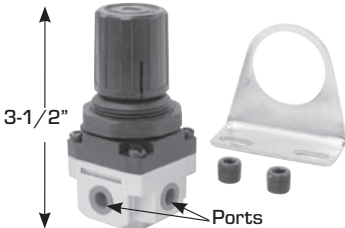
	PART NO.	REPLACES	PORTS
	TWD AC047R	GRANNING: 1066 MANAC: 043-016 NORGREN: R07-100-RNLA PARKER: 14R013FC TURNER: VS1968	1/8" NPT

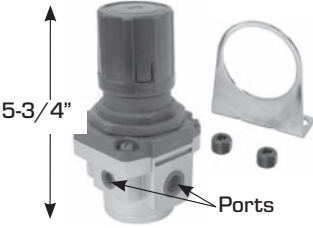
	PART NO.	REPLACES	PORTS	GAUGE PORT
	TWD AC049 GENUINE	MANAC: 023-3011 NORGREN: R73R-3AK-RMN PARKER: 06R113C 06R113AC SCHRADER: 035612000B	3/8" NPT	1/4" NPT

⚠ WARNING: California Proposition 65 - Cancer and Reproductive Harm - www.P65Warnings.ca.gov.



D

SUSPENSION

MISCELLANEOUS VALVES

- Manually operated two-way selector valve
- Applies pilot pressure to actuate dump valves or other accessories

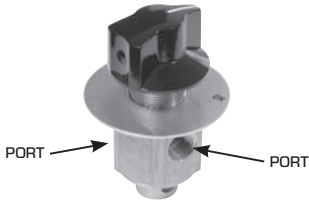
	PART NO.	REPLACES	PORTS
	TWD AC009	MANAC: 023-138 NEWAY: 90054088	1/8" NPT
	TWD AC009K	REPLACEMENT KNOB	

- Air piloted rapid dump valve

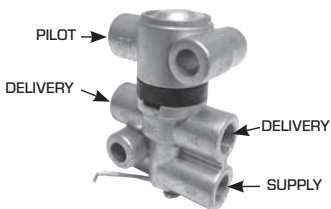
	PART NO.	REPLACES	PORTS
	TWD AC078	GT DEVELOPMENT: 4111 S&S: S16469 TECTRAN: 91-8310 VELVAC: 032195 SLOAN: 401148	1/8" NPT

- Toggle valve with neutral position
- Specially designed for cylinder applications

	PART NO.	REPLACES	PORTS
	TWD AC095	BUYERS: BAV020T	1/8" NPT
	TWD AC095TD	BUYERS: BAV020TD DETENTED	

- Fifth Wheel & general purpose On/Off Air Toggle Switch

	PART NO.	REPLACES	PORTS
	TWD AC199	HOLLAND: XA-02048, XB-01963 VELVAC: 032138	1/8" NPT

⚠ WARNING: California Proposition 65 - Cancer and Reproductive Harm - www.P65Warnings.ca.gov.

MISCELLANEOUS VALVES (continued)

- Three-way miniature ball valve

	PART NO.	REPLACES	PORTS
	TWD AC056	HENDRICKSON: AK147-1, A22535, VS22535 MANAC: 073-034	1/4" NPT
	TWD AC056K	REPLACEMENT KNOB	

⚠ WARNING: California Proposition 65 - Cancer and Reproductive Harm - www.P65Warnings.ca.gov.

AIR PILOT VALVES

- Normally Closed: supply to NC port. NO port becomes exhaust port. CYL port to work
- Normally Open: supply to NO port. NC port becomes exhaust port. CYL to work
- Directional: supply to CYL port. Pilot air shifts NC open and NO closed
- Di-Media: supply #1 to NO; supply #2 to NC. CYL port is common

	PART NO.	REPLACES
	TWD AC105	HUMPHREY: 501A, 501A-3-12-30, 501A31230

- Two Position, Spring Returns, 4-way

	PART NO.	REPLACES
	TWD AC106	HUMPHREY: 501-4A

⚠ WARNING: California Proposition 65 - Cancer and Reproductive Harm - www.P65Warnings.ca.gov.



D

SUSPENSION

MISCELLANEOUS PARTS

- Gauge 0 to 160 PSI
- Stainless steel
- Center mount
- Silicon liquid filled

	PART NO.	REPLACES	DIMENSIONS
	TWD AC063	RIDE-AIR: RA325CL TECTRAN: 80-L25CB1C	2-1/2" DIAMETER X 1/4" NPT

- 12 volt connector
- For HD Plus AC014R & AC045R only

	PART NO.	REPLACES	KIT INCLUDES	
			QTY	DESCRIPTION
	TWD AC014CR	NONE	1	72" HARNESS
			1	LOCKING SCREW
			1	SEAL

- 12 volt Solenoid
- Use for TWD AC014 or TWD AC014R

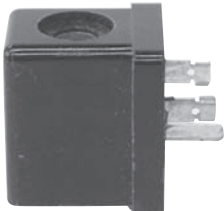
	PART NO.	REPLACES
	TWD AC014SR	NORGREEN: 54932-26

Manual/Electric actuator for TWD AC045R & TWD AC014R

	PART NO.	REPLACES
	TWD AC014HR	NONE

⚠ WARNING: California Proposition 65 - Cancer and Reproductive Harm - www.P65Warnings.ca.gov.

AIR CONTROL BOXES

- Replacement air control box empty
- 18 gauge steel, black powder coated used with TWD AC210, TWD AC211

	PART NO.	REPLACES	DIMENSIONS
	TWD AC100SS STAINLESS STEEL	NONE	8-1/4" X 8-1/4" X 4-1/4"

- Replacement air control box empty
- 18 gauge black powder coated steel, used with TWD AC215, TWD AC220 & TWD AC225
- 18 gauge stainless, used with TWD AC215SS, TWD AC220SS & TWD AC225SS

	PART NO.	REPLACES	DIMENSIONS
	TWD AC200 BLACK POWDER COATED STEEL	RIDE-AIR: RA001A TECTRAN: 27B5, 27B6	12" X 12" X 6-1/2"
	TWD AC200SS STAINLESS STEEL		

- Standard air suspension control box
- Designed to dump air from ride bags only
- 3-way heavy duty hand valve with liquid gauge
- Two box options 8-1/4" X 8-1/4" X 4-1/4"

PRE ASSEMBLED IN A STEEL BOX

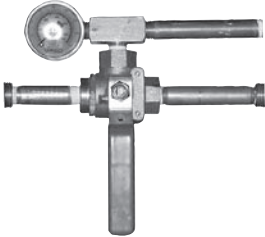
	PART NO.	REPLACES	KIT INCLUDES	
			QTY	DESCRIPTION
	TWD AC211SS STAINLESS STEEL	RIDE-AIR: RA014GLS	1	AC062 LIQUID GAUGE

⚠ WARNING: California Proposition 65 - Cancer and Reproductive Harm - www.P65Warnings.ca.gov.

D

SUSPENSION



AIR CONTROL BOXES (continued)

- Air Suspension 8-1/4" X 8-1/4" Dump Control Box
- 3-way push-pull diverter valve

PRE ASSEMBLED IN A STEEL BOX

KIT INCLUDES

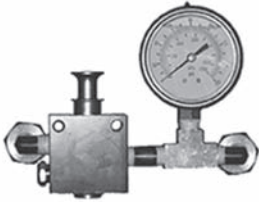
	PART NO.	REPLACES	QTY	DESCRIPTION
	TWD AC345 BLACK POWDER COATED STEEL	RIDE-AIR: RAO15GL	1	AC092 DIVERTER VALVE

- Control Composite Box • All Weather Performance • 6" H. X 6" W. X 4" D.
- Compact - 30 to 40% Smaller & Lighter • All Connection 3/8" Dot Push-to-Connect

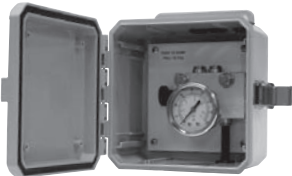
	PART NO.	REPLACES	DESCRIPTION
	TWD AC240	ALKON: TDB-0045 FS-6967-6A	WITH AIR RESET
	TWD AC245	ALKON: TDB-0048 FS-696-7-6B	FULL MANUAL OPERATION VALVE

⚠ WARNING: California Proposition 65 - Cancer and Reproductive Harm - www.P65Warnings.ca.gov.

AIR CONTROL BOX COMPONENTS

REPLACEMENT DOORS

- Replacement door for TWD AC100, TWD AC200, TWD AC400D & TWD AC401D
- Available in steel version only
- Includes latch & hinge

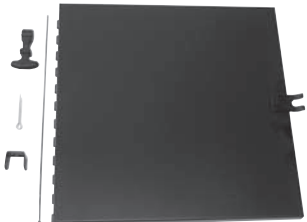
	PART NO.	REPLACES	DIMENSIONS
	TWD AC100D	NONE	8-1/4" X 8-1/4"
	TWD AC200D	RIDE-AIR: RA001A TECTRAN: 27B5, 27B6	12" X 12" X 6-1/2"

⚠ WARNING: California Proposition 65 - Cancer and Reproductive Harm - www.P65Warnings.ca.gov.

D

SUSPENSION

AIR CONTROL BOX COMPONENTS (continued)

LATCHES

- Latch assembly • 12" X 12" X 6-1/2"
- For AC100, AC200, AC400D & AC401D

	PART NO.	NOTE	KIT INCLUDES	
			QTY	DESCRIPTION
	TWD AC200L	USE FOR AC200 BOX	1	RUBBER HANDLE
			1	U-SHAPE STEEL BRAKET
			1	COTTER PIN

TERMINAL BOLT

- Steel terminal bolt

	PART NO.	REPLACES	KIT INCLUDES	
			QTY	DESCRIPTION
	TWD AC072	NONE	1	1/4" NPT X 1" LG. STEEL BOLT
			1	TOOTH LOCK WASHER
			1	NUT

RUBBER GROMMET

	PART NO.	REPLACES	DIMENSIONS
	TWD AC083	NONE	FITS 7/8" HOLE (3/8" CENTER HOLE)
	TWD AC084	NONE	SNAP-IN PLUG, FITS 7/8" HOLE (NO CENTER HOLE)

⚠ WARNING: California Proposition 65 - Cancer and Reproductive Harm - www.P65Warnings.ca.gov.

FRUEHAUF

FRUEHAUF F-2 SUSPENSION - 42" & 44-1/2" AXLE SPACING

D

SUSPENSION

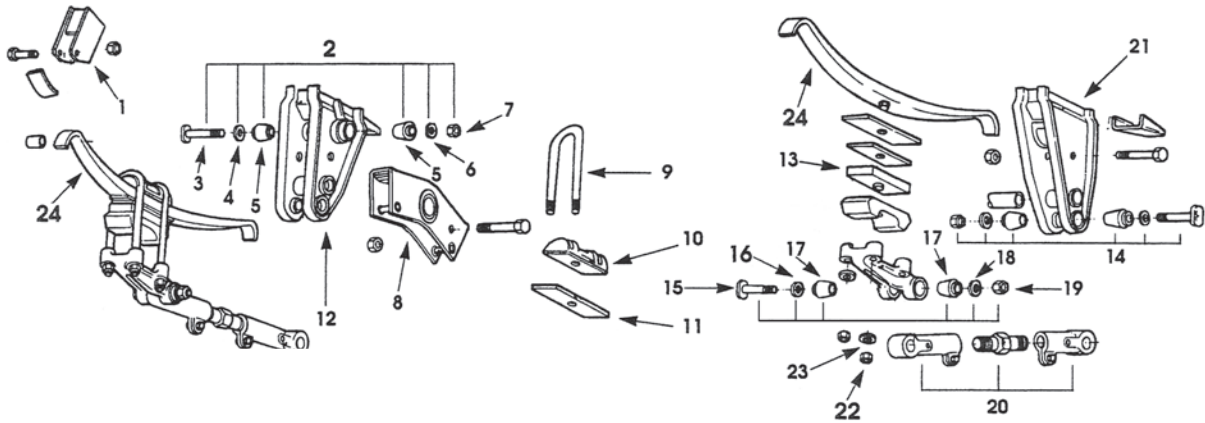

PART NO.	DESCRIPTION	TECHNICAL
TWD FR-UCF2470-001	LH & RH REAR HANGER	—
TWD FR-UXA0015-001	EQUALIZER BOLT	TH 1-14" X 2" X 10-9/16"
TWD FR-UXA0017	EQUALIZER (CAST)	—
TWD FR-UXA0034	LH & RH CENTER HANGER	—
TWD FR-UCF2467-001	LH & RH FRONT HANGER	—
TWD TRA-0015-00	SINGLE LEAF SPRING	USED WITH 42" AXLE SPACING
TWD TRA-0013-00	SINGLE LEAF SPRING	USED WITH 44-1/2" AXLE SPACING
TWD TRA-3603-00	3 LEAF SPRING	USED WITH 44-1/2" AXLE SPACING

⚠ WARNING: California Proposition 65 - Cancer and Reproductive Harm - www.P65Warnings.ca.gov.

FRUEHAUF F-2 SUSPENSION - 49" AXLE SPACING

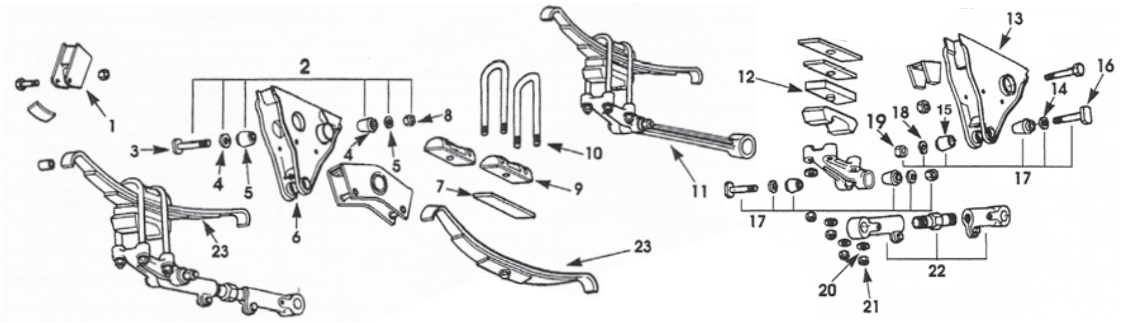

PART NO.	DESCRIPTION	TECHNICAL
TWD FR-UXA0026-001	RIGID TORQUE ARM	15-7/16" CENTER TO CENTER
TWD TRA-0017-00	SINGLE LEAF SPRING MED. 11 M	—
TWD TRA-0697-00	3 LEAF SPRING LOW	—

⚠ WARNING: California Proposition 65 - Cancer and Reproductive Harm - www.P65Warnings.ca.gov.

FRUEHAUF

FRUEHAUF F-2 SUSPENSION 49" AXLE SPACING MISCELLANEOUS PARTS

	PART NO.	DESCRIPTION
	TWD D214	DYCO POLY EQUALIZER BUSHING

⚠ WARNING: California Proposition 65 - Cancer and Reproductive Harm - www.P65Warnings.ca.gov.



TRAILER SUSPENSION PARTS LEAF SPRINGS



PART NO.	DESCRIPTION
TWD TRA-2726-00	3 LEAF SPRING HIGH ARCH 0079-01, 354-00
TWD TRA-2727-00	3 LEAF SPRING MEDIUM ARCH 355-00
TWD TRA-2728-00	3 LEAF SPRING LOW ARCH 0079-02, 356-00
TWD TRA-2740-00	3 LEAF SPRING HIGH ARCH 365-00
TWD TRA-2741-00	3 LEAF SPRING LOW ARCH 365-01

⚠ WARNING: California Proposition 65 - Cancer and Reproductive Harm - www.P65Warnings.ca.gov.

D
SUSPENSION

REYCO

D

SUSPENSION

REYCO SUSPENSION PARTS

	PART NO.		DESCRIPTION
	REYCO	HD PLUS	
	—	TWD T5524R	21B EQUALIZER BUSHING DYCO: POLYURETHANE
	TWD T5427	—	21B FAB EQUALIZER 49" SPREAD
	TWD 14689-01	—	21B FAB EQUALIZER WITH BUSHING 50" SPREAD
	TWD 14696-01	—	21B FAB EQUALIZER WITH BUSHING 60" SPREAD
	TWD 09730-01	—	AXLE SEAT 5" ROUND X 3/4 HT.
	TWD 13805-01	TWD 13805-01R	74, 74A, 74B EQUALIZER BUSHING

⚠ WARNING: California Proposition 65 - Cancer and Reproductive Harm - www.P65Warnings.ca.gov.



REYCO SUSPENSION PARTS (continued)

	PART NO.			DESCRIPTION
	REYCO	HD PLUS	DYCO	
	TWD 14682-01	TWD 14682-01R	—	21B FAB EQUALIZER BUSHING
	—	TWD 15737-01R	—	74B TORQUE ARM BUSHING 1" BOLT
	TWD 23421-01	—	—	AR SERIES BEAM BUSHING
	TWD T5493	TWD T5493R	TWD D071	21B, 21B-FAB, 21C, 74 TORQUE ARM BUSHING - RUBBER DYCO: POLYURETHANE
	PART NO.			DESCRIPTION
	REYCO			
	TWD T5565			LEFT REAR HANGER CAST 21B SUSPENSION
	TWD T5566			RIGHT REAR HANGER CAST 21B SUSPENSION

D

SUSPENSION

⚠ WARNING: California Proposition 65 - Cancer and Reproductive Harm - www.P65Warnings.ca.gov.

REYCO

REYCO SUSPENSION PARTS (continued)

D



SUSPENSION

	PART NO.	DESCRIPTION	
	REYCO		
	TWD 09729-01	21C, 73, 83, 91 TORQUE ARM BUSHING 3" LONG, FOR 7/8" BOLT DYCO: POLYURETHANE	
	TWD 10051-01	73, 83, 91 TORQUE ARM BUSHING 3-3/8" LONG, FOR 7/8" BOLT	
	TWD 08595-01	21B FAB UNDERMOUNT REAR SPRING HANGER	
	TWD 09832-01	21B FAB UNDERMOUNT FRONT SPRING HANGER	
	TWD 15172-01	ADJUSTABLE TORQUE ARM 16-1/2"	
	TWD TK18998	21B EQUALIZER REBUSHING KIT	
		QTY	DESCRIPTION
		2	HD LOCK WASHER
		1	BOLT
		2	SHAFT
		2	COMPRESSION WASHER
2	EQUALIZER BUSHING		
	TWD TK7319	21B & 21B-FAB, 21C, 74 TORQUE ARM REBUSHING KIT	
		QTY	DESCRIPTION
		16	WASHER
		8	BOLT
		16	BUSHING
8	LOCK NUT		

⚠ WARNING: California Proposition 65 - Cancer and Reproductive Harm - www.P65Warnings.ca.gov.



REYCO SUSPENSION PARTS - KITS (continued)

REYCO	DESCRIPTION	
	83 T/A REBUSH KIT	
	QTY	DESCRIPTION
	1	BUSHING
	21B-FAB, 83 TORQUE ARM REBUSHING KIT	
	QTY	DESCRIPTION
	1	EQUALIZER BUSHING

⚠ WARNING: California Proposition 65 - Cancer and Reproductive Harm - www.P65Warnings.ca.gov.

REYCO LEAF SPRINGS



PART NO.	OEM	DESCRIPTION	APPLICATION
TWD TRA-2270-00	T3564	8 LEAF SPRING	FOR 21B, 22B, 22B-N
TWD TRA-2297-00	T7452	9 LEAF SPRING	FOR 21B, 21-1/2B, 25, 45
TWD 998-0046-00	T7452HD	SPRING (TRA2297,10 L)	FOR 21B, 21-1/2B, 25, 45
TWD TRA-3343-00	13856-01	10 LEAF SPRING	FOR 74B MODELS

⚠ WARNING: California Proposition 65 - Cancer and Reproductive Harm - www.P65Warnings.ca.gov.

D
SUSPENSION



D

SUSPENSION

REPAIR KITS & COMPONENTS

UPPER CONTROL ARM BUSHING & BOLT KIT (FOR 1 UPPER CONTROL ARM)

	KIT PART NO.	KEY NO.	KIT ITEM	QTY	DESCRIPTION
	TWD KIT11300	24	1	4	PIVOT BOLT - 7/8" - 9 X 6", GRADE A-490
		25	2	8	HARDENED FLAT WASHER 7/8" I.D.
		27	3	4	TORQUE NUT, 7/8" - 9, GRADE C
		22	4	8	THRUST WASHER
		21	5	4	BUSHING
		23	6	2	PIVOT BOLT WASHER, 3" O.D. X 7/8" I.D. X 1/2" THK
		-	7	1	P-80 RUBBER LUBRICANT

UPPER CONTROL ARM BOLT KIT FOR ALL OTHER POSITIONS (NON ADJUSTABLE)

	KIT PART NO.	KEY NO.	KIT ITEM	QTY	DESCRIPTION
	TWD KIT11107	24	1	1	PIVOT BOLT - 7/8" - 9 X 6", GRADE A-490
		25	2	2	HARDENED FLAT WASHER - 7/8" I.D.
		27	3	1	TORQUE NUT, 7/8" - 9, GRADE C



⚠ WARNING: California Proposition 65 - Cancer and Reproductive Harm - www.P65Warnings.ca.gov.



AUXILIARY SPRING KITS

HAULMAAX/HN	PART NO.	DESCRIPTION	
	TWD 64179-004	STANDARD SPRING - ONE SET	
		QTY	DESCRIPTION
		1	AUXILIARY SPRING
		3	1/2" FLANGE BOLT - 2.25"
3	1/2" FLANGE NUT		

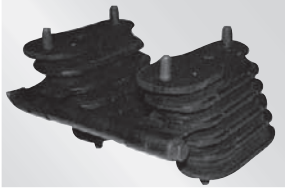
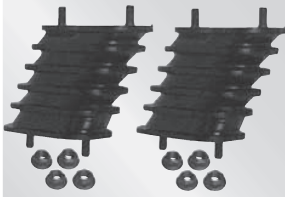
⚠ WARNING: California Proposition 65 - Cancer and Reproductive Harm - www.P65Warnings.ca.gov.

BOLSTER SPRING KITS			
HAULMAAX/HN	PART NO.	DESCRIPTION	
	TWD 64179-037	HAULMAAX 40K/46K - ONE SET	
		QTY	DESCRIPTION
		2	TIE-BAR BOLSTER SPRINGS
		1	BOLSTER SPRING SPACER
		9	1/2" - 13 UNC FLANGE NUT
	TWD 64179-002	HAULMAAX 40K - ONE SET	
		QTY	DESCRIPTION
		2	BOLSTER SPRINGS
	TWD 60879-000L	HN 40K/46K - ONE SET	
		QTY	DESCRIPTION
		2	BOLSTER SPRINGS

⚠ WARNING: California Proposition 65 - Cancer and Reproductive Harm - www.P65Warnings.ca.gov.

©COPYRIGHT HENDRICKSON.

EQUALIZING BEAM BUSHING KITS			
R/RS/RT/RTE	PART NO.	DESCRIPTION	
 <p>Kit Shown: 30437-000L</p>	TWD 30436-000L	340 SERIES - TWO BEAMS	
		QTY	DESCRIPTION
		2	BRONZE CENTER BUSHING
		2	BEAM CENTER SLEEVE
		4	BEAM CENTER SEAL
		8	THRUST WASHER
	TWD 30437-000L	2	GREASE FITTING
		380-520 SERIES - TWO BEAMS	
		QTY	DESCRIPTION
		2	BRONZE CENTER BUSHING
		2	BEAM CENTER SLEEVE
4	BEAM CENTER SEAL		
8	THRUST WASHER		
2	GREASE FITTING		

⚠ WARNING: California Proposition 65 - Cancer and Reproductive Harm - www.P65Warnings.ca.gov.



©COPYRIGHT HENDRICKSON.



EQUALIZING BEAM BUSHING KITS (continued)

D



SUSPENSION

R/RS/RT/RTE	PART NO.	DESCRIPTION	
	TWD 34013-054L	380-520 SERIES - ONE BEAM	
		QTY	DESCRIPTION
		1	BRONZE CENTER BUSHING
		1	BEAM CENTER SLEEVE
		2	BEAM CENTER SEAL
		4	THRUST WASHER
1	GREASE FITTING		
AR2/R/RS/RT/RTE	PART NO.	DESCRIPTION	
 <p>Kit Shown: 34013-049L</p>	TWD 34013-049L	440 SERIES - ONE WHEEL END	
		QTY	DESCRIPTION
		1	END BUSHING
	TWD 34013-050L	1	END BUSHING ADAPTER KIT
		QTY	DESCRIPTION
		1	END BUSHING
	TWD 34013-050L	1	END BUSHING ADAPTER KIT
		QTY	DESCRIPTION
		1	END BUSHING
	TWD 34013-048L	1	END BUSHING
QTY		DESCRIPTION	
1		END BUSHING ADAPTER KIT	
 <p>Kit Shown: 45000-007L</p>	TWD 45000-007L	440 SERIES - ONE WHEEL END	
		QTY	DESCRIPTION
		1	3/4"-16 UNF BOLT - 6.5"
		2	3/4" HARDENED WASHER
		1	3/4"-16 UNF LOCKNUT
		2	BEAM END ADAPTER
1	ADAPTER TUBE		
TWD 45000-013L	QTY	DESCRIPTION	
	1	3/4"-16 UNF BOLT - 6.0"	
	2	3/4" HARDENED WASHER	
	1	3/4"-16 UNF LOCKNUT	
	2	BEAM END ADAPTER	
	1	ADAPTER TUBE	

⚠ WARNING: California Proposition 65 - Cancer and Reproductive Harm - www.P65Warnings.ca.gov.

©COPYRIGHT HENDRICKSON.

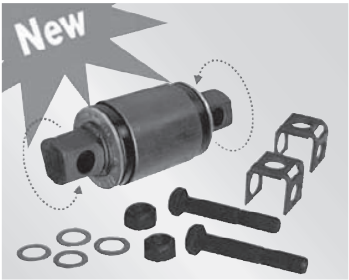
EQUALIZING BEAM BUSHING KITS (continued)

AR2/R/RS/RT/RTE	PART NO.	DESCRIPTION	
	TWD 21140-004	850 SERIES - ONE WHEEL END	
		QTY	DESCRIPTION
		2	1-7/8"-12 UNF SLOTTED NUT
		2	COTTER PIN
		2	BEAM END ADAPTER
		1	BEAM END SHAFT
		1	THRUST WASHER
AR2/HAULMAAX/HN/R/RS/RT/RTE	PART NO.	DESCRIPTION	
		ONE BEAM END WITH SHIMS	
		QTY	DESCRIPTION
		2	1"-8 UNC HEX BOLT - 6.0"
		4	1" HARDENED WASHER
		2	1"-8 UNC LOCKNUT
		2	BAR PIN SHIM 0.25" X 0.12"
1	BAR PIN END BUSHING (SHIM)		
	TWD 34013-188L	ONE BEAM END WITH SHIMS	
		QTY	DESCRIPTION
		2	1"-8 UNC HEX BOLT - 6.0"
		4	1" HARDENED WASHER
		2	1"-8 UNC LOCKNUT
		2	BAR PIN SHIM 0.25" X 0.12"
		1	BAR PIN END ROTATING BUSHING (SHIM)
	TWD 34013-087L	ONE BEAM END NON-SHIM	
		QTY	DESCRIPTION
		2	1"-8 UNC HEX BOLT - 6.0"
		4	1" HARDENED WASHER
		2	1"-8 UNC LOCKNUT
		1	BAR PIN END BUSHING (NON SHIM)

⚠ WARNING: California Proposition 65 - Cancer and Reproductive Harm - www.P65Warnings.ca.gov.

©COPYRIGHT HENDRICKSON.



D

SUSPENSION

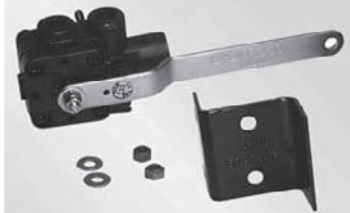

HEIGHT CONTROL VALVE KITS

AR2/COMFORT AIR/HAS/ PARASTEER/PRIMAAX/PRIMAAX EX	PART NO.	DESCRIPTION	
 <p>Kit Shown: 57977-000</p>	TWD 57977-000	DUMP VALVE - ONE SIDE	
		QTY	DESCRIPTION
		1	HCV INTEGRATED DUMP VALVE
		1	HCV MOUNTING BRACKET
		2	1/4" HARDENED WASHER
	2	1/4"-20 UNC LOCKNUT	
	TWD 59013-000	DUMP VALVE - ONE SIDE	
		QTY	DESCRIPTION
		1	HEIGHT CONTROL VALVE
		2	1/4" HARDENED WASHER
2		1/4"-20 UNC LOCKNUT	

⚠ WARNING: California Proposition 65 - Cancer and Reproductive Harm - www.P65Warnings.ca.gov.

©COPYRIGHT HENDRICKSON.

QUIK-ALIGN® COLLAR & PIVOT BUSHING KITS

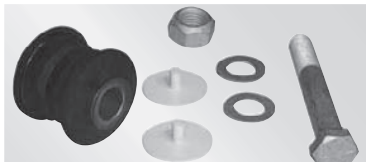
AL405/COMFORT AIR/FIREMAAX EX/MAXAIR/PRIMAAX EX	PART NO.	DESCRIPTION	
	TWD 60683-001	MACK-AL405/MAXAIR - TANDEM SET	
		QTY	DESCRIPTION
		2	ECCENTRIC COLLAR
		6	CONCENTRIC COLLAR
		4	7/8"-8 UNC BOLT - 7.5"
		8	7/8" HARDENED WASHE
		4	7/8"-8 UNC LOCKNUT
		4	PIVOT BUSHING
	TWD 60682-001	MACK-AL405/MAXAIR - ONE WHEEL END	
		QTY	DESCRIPTION
		1	ECCENTRIC COLLAR
	TWD 34013-103	COMFORT AIR - ONE WHEEL END	
		QTY	DESCRIPTION
		1	PIVOT BUSHING

⚠ WARNING: California Proposition 65 - Cancer and Reproductive Harm - www.P65Warnings.ca.gov.

©COPYRIGHT HENDRICKSON.



TORQUE ROD KITS - ULTRA ROD® TWO-PIECE

AR2/COMFORT AIR/HAS/HAULMAAX/ HN/PRIMAAX EX/R/RS/RT/RTE	PART NO.	DESCRIPTION	
	TWD 60218-000	QTY	DESCRIPTION
		1	TUBE END, 5/8" HOLE DIA. 47691-000H BUSHING
	1	SPACER END, 5/8" HOLE DIA. 47691-000H BUSHING	
	TWD 60215-000	QTY	DESCRIPTION
		1	TUBE END, 5/8" HOLE DIA. 47691-000H BUSHING
		1	3" TAPER END 64697-000H BUSHING

⚠ WARNING: California Proposition 65 - Cancer and Reproductive Harm - www.P65Warnings.ca.gov.

©COPYRIGHT HENDRICKSON.

D
SUSPENSION



GREASE FITTINGS

	PART NO.	TYPE THREAD	TYPE & DEGREES
	TWD G1813	1/8" - 28 BPT	STRAIGHT 20 MM LONG
	TWD G1815	1/8" - 28 BPT	90° ELBOW

⚠ WARNING: California Proposition 65 - Cancer and Reproductive Harm - www.P65Warnings.ca.gov.



HEAVY-DUTY SHOCKS

The Monroe® Advantage

Application-engineered shocks for class 3-8 trucks, designed to help deliver safe steering, stopping, and stability and a reduced cost-per-mile. Normally used in conjunction with air spring suspensions, the purpose of the "lock out" is to cushion the full extension position of shock absorber travel. This limits over-extension of the suspension, prevents top-out of the piston, and averts damage to the seal assembly.

D

SUSPENSION

MONROE® MAGNUM 65

Application-engineered for class 6 to 8 vehicles. The Monroe® Gas-Magnum® 65 shock absorber is a large-bore shock specifically designed for air spring and taper leaf suspensions. Its nitrogen gas charge provides the fast response needed for heavy truck suspensions. Its extra-large piston bore is engineered to handle the demands of high mileage and severe use.



PART NO.	DESCRIPTION
NS 65102	FORD/KENWORTH
NS 65408	FREIGHTLINER
NS 65409	IH/NAVISTAR
NS 65404	KENWORTH
NS 65101	PETERBILT
NS 65402	PETERBILT
NS 65103	VOLVO/WHITE/GMC
NS 65105	VOLVO/WHITE/GMC

MONROE® MAGNUM 60

Application-engineered for class 3 to 8 vehicles. The Monroe® Gas-Magnum® 60 shock absorber is gas-charged for quicker response and a stable, more comfortable ride. Replacing worn out units with hard-working Gas Magnum 60 shocks can help reduce excessive vibration. The result can be better tire life, less downtime, and a lower cost per mile.



PART NO.	DESCRIPTION
NS 66833	FORD TRUCK
NS 66861	FORD/IHC
NS 66893	FREIGHTLINER
NS 66628	GM HD
NS 66637	GM HD
NS 66913	GM HD
NS 66605	GM HD/IHC/ISU
NS 66923	IH/NAVISTAR

⚠ WARNING: California Proposition 65 - Cancer and Reproductive Harm - www.P65Warnings.ca.gov.



HEAVY-DUTY SHOCKS (continued)

MONROE® MAGNUM 70

	PART NO.	DESCRIPTION
	NS 65490	FREIGHTLINER
	NS 74025	HD TRUCK/BUS
	NS 65420	KENWORTH/PETERBILT
	NS 74028	VARIOUS BUS/TRUCK

MAGNUM 55 RECREATIONAL VEHICLE

	PART NO.	DESCRIPTION
	NS 557003	73-03 GM MOTORHOME
	NS 557004	73-03 GM MOTORHOME
	NS 555033	75-91 FORD MOTORHOME
	NS 557001	88-04 FORD MOTORHOME
	NS 555010	92-04 FORD MOTORHOME
	NS 555032	92-04 FORD MOTORHOME
	NS 557007	99-04 GM MOTORHOME
	NS 555001	TRAVEL TRAILER (DEXTER AXLE)

CAB SHOCKS

Application-engineered for today's cab suspensions. Monroe® Gas-Magnum® Cab Shocks isolate the cab from the frame, providing a smoother, more comfortable ride. Specifically designed for HD cab suspensions, they utilize patented groove tube technology and velocity-sensitive valving.

	PART NO.	DESCRIPTION
	NS 66147	FREIGHTLINER
	NS 66118	FREIGHTLINER
	NS 66157	IH/NAVISTAR
	NS 66159	IH/NAVISTAR
	NS 66104	KENWORTH/MACK/PETERBILT
	NS 66143	MACK
	NS 66145	PETERBILT
	NS 66123	VOLVO/WHITE/GMC

⚠ WARNING: California Proposition 65 - Cancer and Reproductive Harm - www.P65Warnings.ca.gov.

D

SUSPENSION



AIROGEAR AIR SPRINGS

AIROGEAR

3 YEAR LIMITED WARRANTY



D
SUSPENSION

- ✓ **AIROGEAR** is developed and engineered for North American environmental conditions and is also manufactured in North America
- ✓ **AIROGEAR** is the perfect solution for cost conscious customers
- ✓ **AIROGEAR** has been tested to exceed the performance of similar price point and off-shore products
- ✓ **AIROGEAR** is a good option for the price, when it comes to extending the useful life of vehicles

PART NO.	APPLICATION
TWD AGA1191	Navistar/International 3541731C1
TWD AGA8050	Hendrickson B-4771, Reyco, Watson & Chalin
TWD AGA8091	Hendrickson S-20901
TWD AGA8204	Holland Neway 90557173 (RL 196A-12)
TWD AGA8708	Hendrickson S-21966
TWD AGA8709	Hendrickson S-21800
TWD AGA8713	Hendrickson S-22948
TWD AGA8729	Arvinmeritor A2258F1410, 202796
TWD AGA8755	Hendrickson S-22045 (HT 190T)
TWD AGA8829	Volvo 3934699, 8079902
TWD AGA8852	Peterbilt 03-07887
TWD AGA9069	Peterbilt 03-07112
TWD AGA9082	Hendrickson B-2066
TWD AGA9122	Hendrickson Trailer S3467, S3830, Holland Neway 90557071, 90557076, 90557077, Hendrickson Gen. B-12514-008, B-12514-010, Porcupine Reyco 12883-02, Sauer P50-732, Ridewell 1003589122C, Termisko Watson & Chalin AS-0023, Holland Neway 90557185 (Parallel Align)
TWD AGA9265	Hendrickson S-20124
TWD AGA9270	Hendrickson S-20010
TWD AGA9373	Hendrickson 57122-2 (Ford, Class 8) HAS-360/400/402/460
TWD AGA9422	Kenworth (Airglide 100) K303-6, K303-14, K303-15
TWD AGA9541	Kenworth C81-1005 Airglide 200 5/5/2003 Or Later, Airglide 460, Airglide 690
TWD AGA9580	Hendrickson S20127 (HT-250U, HT-250-Y)
TWD AGA9622	Kenworth Airglide 200, K-303-22
TWD AGA9648	Navistar/International 2027911C1, 2027911C2
TWD AGA9780	Freightliner A16-18335-000, 16-13810-000, 16-19468-000
TWD AGA9781	Freightliner A16-14004-000 W/ Aluminum Piston
TWD AGA9807	Holland Neway (C8-400) 90557372

⚠ WARNING: California Proposition 65 - Cancer and Reproductive Harm - www.P65Warnings.ca.gov.

AIR SPRING MAINTENANCE

Firestone air springs are designed to provide years and thousands of miles of trouble free service. Firestone air springs are so durable that they will often outlast other maintenance items on your suspension, such as bushings, shocks, leveling valves or regulators. Firestone Airide™ springs are warranted to be free of material defects and/or workmanship for various periods of time, depending upon the application.

Firestone offers a complete line of Airide springs, with replacement springs available for virtually every vehicular air suspension system. Since each individual air spring is closely examined and pressure tested at the factory, the vast majority of premature failures and consequent warranty returns are found not to be defective, but fail because of abuse caused by other problems associated with the suspension. Before you install a new air spring, you should carefully examine the old one to determine what caused it to fail. If it was due to an issue in the suspension system, then the new air spring may also fail unless you correct the problem.

Air Spring Maintenance FAQs

1 Where are the possible locations for Firestone air springs?

Firestone air springs can be found at a number of locations on the truck and trailer, including the primary suspension springs for the truck and trailer, auxiliary axles (such as a lift axle), as well as the cab suspension and often a front (steering axle) suspension. It is important to take note of all your air spring locations so that all of the locations receive proper maintenance.

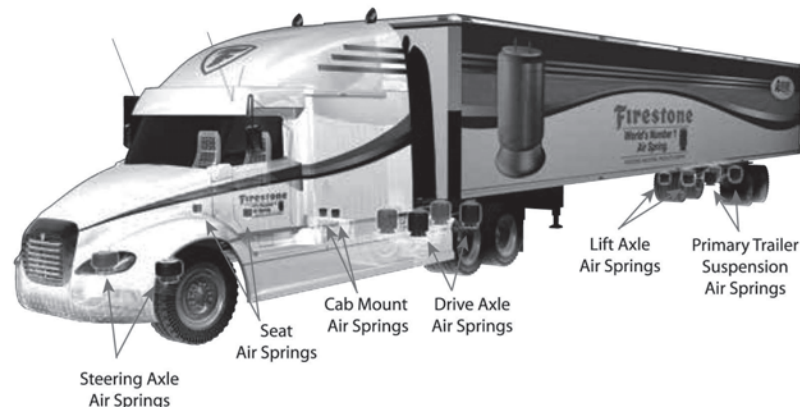

2 How often should I inspect my Firestone air springs?

This depends somewhat on usage of the vehicle or trailer. The inspection could be based on frequency (such as quarterly or bi-annually), mileage (such as 50,000 miles) or in conjunction with other suspension maintenance activities.

3 What should I look for when I inspect my Firestone air springs?

During your routine inspection of Firestone air springs take special note of any debris, cuts, deformities, or rubs that may lead to an imminent failure. If the air spring is damaged, replace it during this visual inspection process. If the air spring is damaged there is also a high probability that there may be other problems with the suspension, or other damaged components.

4 Do my Firestone air springs ever need to be cleaned?

Once per year, when performing a thorough inspection it is advised to clean the air spring with a soapy water or alcohol solution. This will help expose problems hidden from normal visual inspection. Soap bubbles may also help identify slow leaks that could be occurring, indicating a failing air spring. Do not expose air springs to open flames, solvents or abrasives or else you may unintentionally damage the air spring, particularly the rubber.

- APPROVED: soap and water, methyl alcohol, ethyl alcohol and isopropyl alcohol
- NON-APPROVED: all organic solvents, open flames, abrasives and direct pressurized steam cleaning.

5 Can I use an impact wrench to install my Firestone air bags?

It is advised that an impact wrench is not used to install Firestone air bags. An impact wrench increases the danger of stripping the fittings off the bead plate. A torque table showing the installation force on various sizes of fasteners is available via a sticker on top of every new part and in our catalogs. It is important to follow these guidelines and use torque wrenches to achieve these recommended tightness values. It is important to check the tightness of all mounting hardware (nuts and bolts), if loose re-torque to manufacturer's specifications-do not over tighten.

When properly maintained, Firestone Airide air springs are designed to last millions of cycles. The complete inspection process will take just a matter of minutes to perform and could save you both time and money. For complete air spring maintenance please go to <http://www.firestoneip.com/preventativeMaintenance.aspx> or reference page 4 in our Heavy Duty catalog.

Firestone

AIR SPRING MAINTENANCE (continued)

D

SUSPENSION

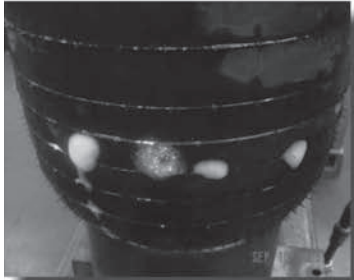

Annual Inspection

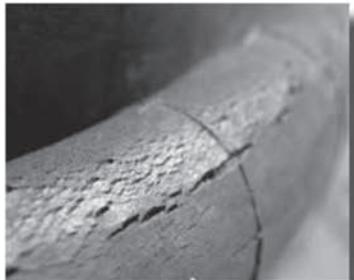

Age Cracking

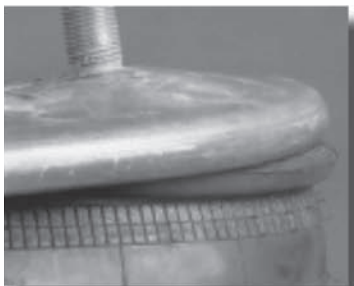

Over Extension

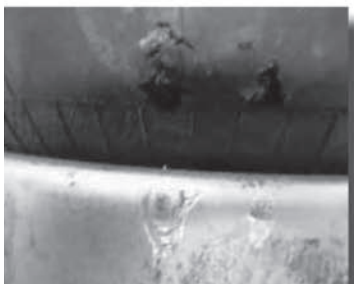

Trapped Debris

Listed below are items that can be checked when the vehicle is in for periodic maintenance. Never attempt to service the air suspension on a truck or trailer with the air springs inflated.

- 1** Inspect the OD (Outside Diameter) of the air spring. Check for signs of irregular wear or heat cracking.
- 2** Inspect air lines to make sure contact doesn't exist between the air line and the O.D. of the air spring. Air lines can rub a hole in an air spring very quickly.
- 3** Check to see that there is sufficient clearance around the complete circumference of the air spring while at its maximum diameter.
- 4** Inspect the O.D. of the piston for buildup of foreign materials. (On a reversible sleeve style air spring, the piston is the bottom component of the air spring).
- 5** Correct ride height should be maintained. All vehicles with air springs have a specified ride height established by the O.E.M. manufacturer. This height, which is found in your service manual, should be maintained within 1/4". This dimension can be checked with the vehicle loaded or empty.
- 6** Leveling valves (or height control valves) play a large part in ensuring that the total air spring system works as required. Clean, inspect and replace, if necessary.
- 7** Make sure you have the proper shock absorbers and check for leaking hydraulic oil and worn or broken end connectors. If a broken shock is found, replace it immediately. The shock absorber will normally limit the rebound of an air spring and keep it from overextending.
- 8** Check the tightness of all mounting hardware (nuts and bolts). If loose, re-torque to the manufacturer's specifications. Do not over-tighten.
- 9** Clean the air spring with approved cleaning materials

APPROVED: soap and water, methyl alcohol, ethyl alcohol and isopropyl alcohol

NON-APPROVED: all organic solvents, open flames, abrasives and direct pressurized steam cleaning.

Firestone

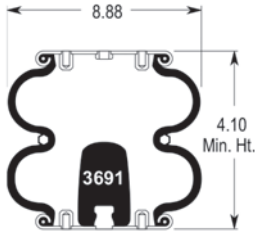
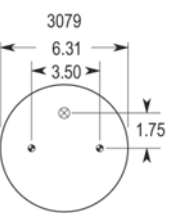
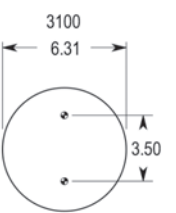
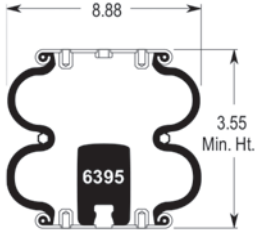
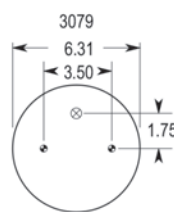
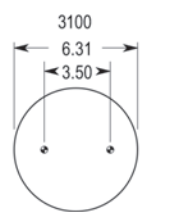
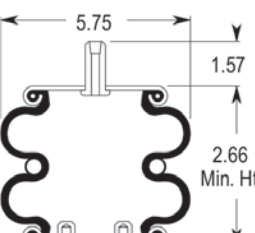
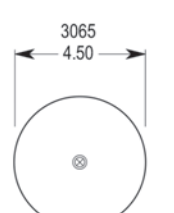
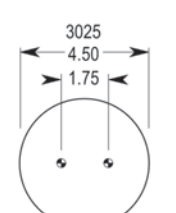
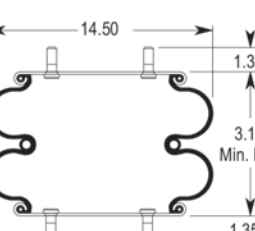
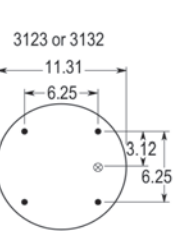
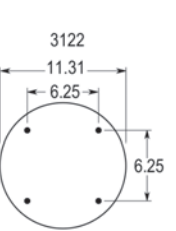
PART NO.	CROSS SECTION VIEW	BREAD PLATE TOP VIEW	BREAD PLATE BOTTOM VIEW	ASSY. WEIGHT (LBS)	REPLACES
TWD W01-358-6926				N/A	LOAD SHARE
TWD W01-358-6935				N/A	HENDRICKSON TRAILER S14318 HLM LIFT BAG HENDRICKSON AUX. 003318 (METRIC VERSION)
TWD W01-358-7057				6.7	SAUER P10-794
TWD W01-358-7135				17.8	HOLLAND (NEWAY) 90557001 PEZZANI AR-21-A RIDEWELL 1003587135C SILENT DRIVE TRUCKSTELL (MARION MFG.) 63641 TRUCKSTELL (MARION MFG.) 63644 HENDRICKSON CAN. B-12514-014

⚠ WARNING: California Proposition 65 - Cancer and Reproductive Harm - www.P65Warnings.ca.gov.

D

SUSPENSION

Firestone

D

SUSPENSION

PART NO.	CROSS SECTION VIEW	BREAD PLATE TOP VIEW	BREAD PLATE BOTTOM VIEW	ASSY. WEIGHT (LBS)	REPLACES
TWD W01-358-7136				19.8	FARGO TRAILER GRANNING 1626 HENDRICKSON TRAILER S1080 R & S TRUCK & BODY 1027556 RIDEWELL 1003587136C WATSON & CHALIN AS-0004
TWD W01-358-7403				14.0	GRANNING 2725 HENDRICKSON TRAILER S1159 HENDRICKSON TRAILER S2883 HENDRICKSON CAN. B-12514-001 R & S TRUCK & BODY 1040201 RIDEWELL 1003587403C WATSON & CHALIN AS-0007
TWD W01-358-7410				14.6	FREIGHTLINER 16-11378-000
TWD W01-358-7424				12.6	INTERGRATED HOLLAND (NEWAY) 90557014 (AL-41 & 45) PORCUPINE R & S TRUCK & BODY 1090215 SAUER P10-755
TWD W01-358-7472				12.6	HENDRICKSON CAN. B-12514-005

⚠ WARNING: California Proposition 65 - Cancer and Reproductive Harm - www.P65Warnings.ca.gov.

Firestone

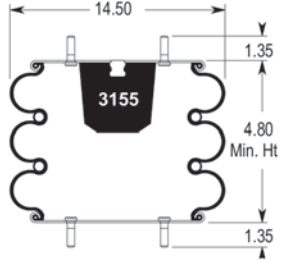
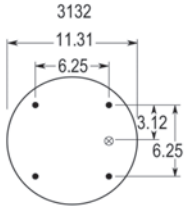
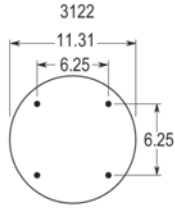
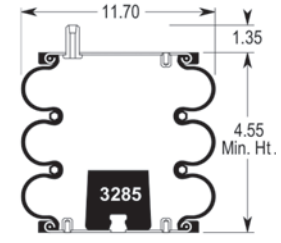
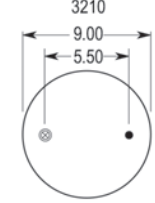
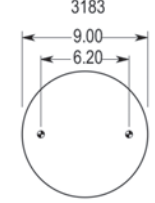
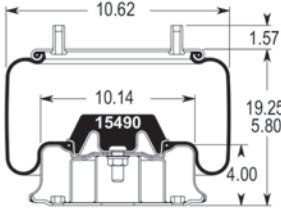
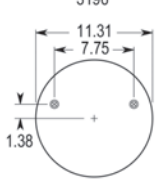
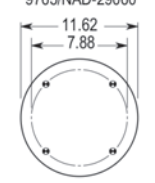
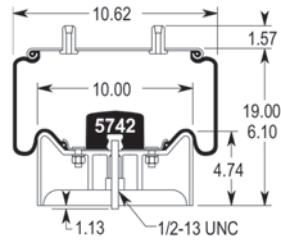
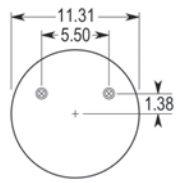
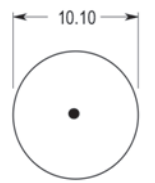
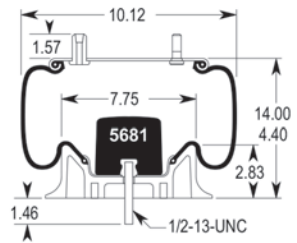
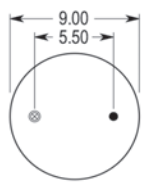
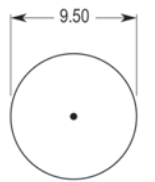
PART NO.	CROSS SECTION VIEW	BREAD PLATE TOP VIEW	BREAD PLATE BOTTOM VIEW	ASSY. WEIGHT (LBS)	REPLACES
TWD W01-358-7818				24.2	EZ RIDE 8030180 GRANNING 1014 RIDEWELL 1003587818C SUPERIOR WATSON & CHALIN AS-0025
TWD W01-358-8008				17.7	EZ RIDE HISTEER RIDEWELL 1003588008C SILENT DRIVE WATSON & CHALIN AS-0019 HENDRICKSON TRAILER S11637
TWD W01-358-8050 (WAS 1T19J-6)				21.7	HENDRICKSON TRAILER S4771
TWD W01-358-8091 (WAS 1T19FC-5)				17.9	HENDRICKSON TRAILER S20901 (INTRAAX 250) REUSE METAL DISK HENDRICKSON TRAILER S21784 W/METAL DISK FOR PISTON SUPPORT
TWD W01-358-8204				10.7	HOLLAND (NEWAY) 90557173 (RL196A-12) HOLLAND (NEWAY) 90557223 BINKLEY NEWLITE (NS 190-16)

⚠ WARNING: California Proposition 65 - Cancer and Reproductive Harm - www.P65Warnings.ca.gov.

D

SUSPENSION

Firestone

D

SUSPENSION

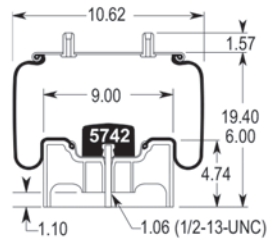
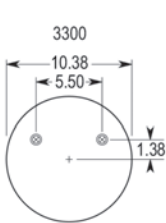
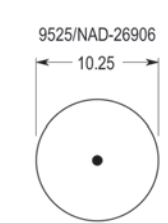
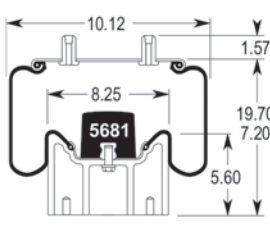
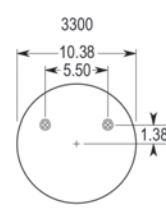
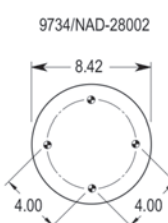
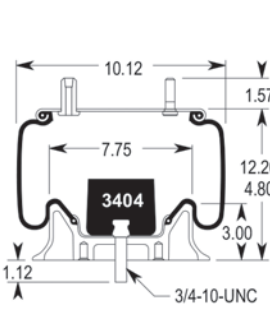
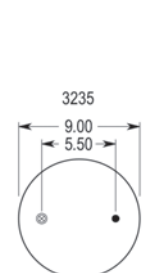
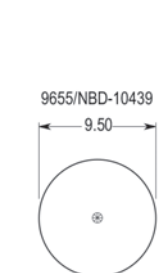
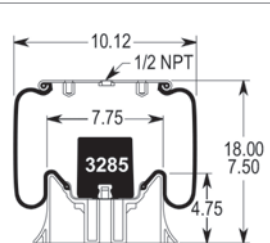
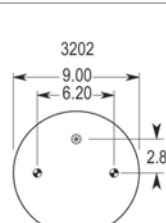
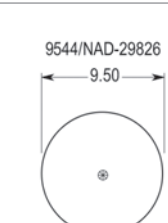
PART NO.	CROSS SECTION VIEW	BREAD PLATE TOP VIEW	BREAD PLATE BOTTOM VIEW	ASSY. WEIGHT (LBS)	REPLACES
TWD W01-358-8709				14.1	HENDRICKSON TRAILER S21800 (INTRAAX AA230) [8/97-UP] -REPLACES W01-358-8751 (APPROX. 6/98)
TWD W01-358-8755				17.1	HENDRICKSON TRAILER S22045 (HK190T) HENDRICKSON TRAILER PROTOTYPE C21623
TWD W01-358-9039 (SERVICE ASSEMBLY TWD W01-358-0702)				13.4	HENDRICKSON TRAILER S2064/S11650 HOLLAND (NEWAY) 90557001 HOLLAND (NEWAY) 90557023 HOLLAND (NEWAY) 90557085 HUTCHENS H-9424-01 R & S TRUCK & BODY 1090218 RIDEWELL 1013589039C FABTEK 101827 SAUER P50-734 WATSON & CHALIN AS-0012
TWD W01-358-9069				14.2	PETERBILT 03-02456 PETERBILT 03-04759 PETERBILT 03-01649 PETERBILT 03-06746 PETERBILT 03-07112 PETERBILT 03-02038 (AIR-TRAC) MFG.SV# PETERBILT 03-10042

⚠ WARNING: California Proposition 65 - Cancer and Reproductive Harm - www.P65Warnings.ca.gov.

Firestone

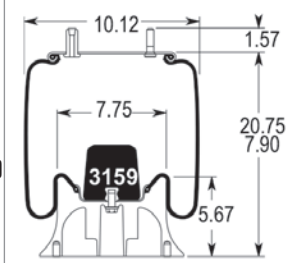
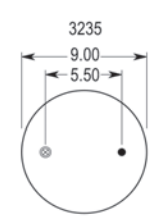
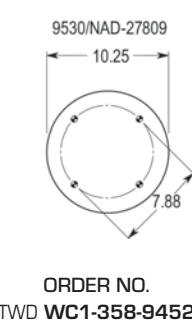
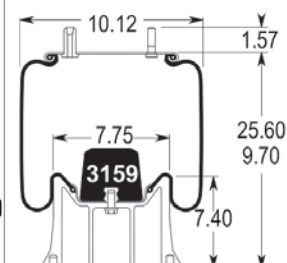
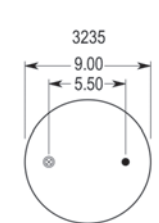
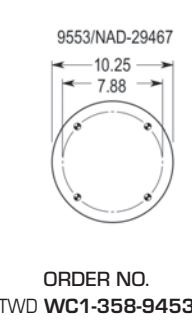
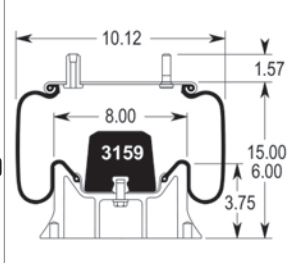
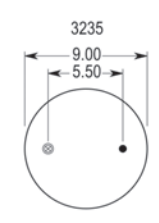
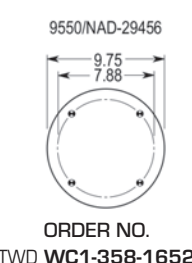
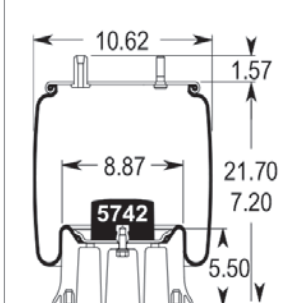
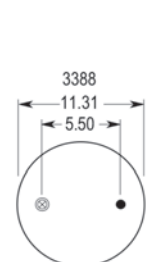
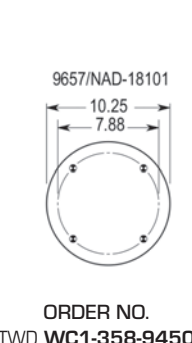
PART NO.	CROSS SECTION VIEW	BREAD PLATE TOP VIEW	BREAD PLATE BOTTOM VIEW	ASSY. WEIGHT (LBS)	REPLACES
TWD W01-358-9082 (SERVICE ASSEMBLY TWD W01-358-0712)				-	HENDRICKSON CAN. S2066, S11651, B-12514-007 KELDERMAN HUTCHENS H-9630-01 KWIK LOK/TODO (JIFFLOX) CP-5125 HOLLAND (NEWAY) 90557006, 90557027, 90557033 (SPECIAL MOUNTING), 90557037, 90557054, 90557075 REYCO 12882-01 R & S TRUCK & BODY
TWD W01-358-9101 (SERVICE ASSEMBLY TWD W01-358-9102)				16.7	HOLLAND (NEWAY) 90557008 HOLLAND (NEWAY) 90557009 HOLLAND (NEWAY) 90557082 RIDEWELL 1003589101C REYCO 12883-01 SILENT DRIVE TRUCKSTELL (MARION MFG.) 63647 MFG.SV.# NEWAY 90044201 WATSON & CHALIN AS-0040
TWD W01-358-9105 (SERVICE ASSEMBLY TWD W01-358-0725)				13.2	HENDRICKSON TRAILER S1245 GRANNING 5065 RIDEWELL 1003589105C WATSON & CHALIN AS-0015
TWD W01-358-9121				21.7	HOLLAND (NEWAY) 90557019 HOLLAND (NEWAY) 90557052 HOLLAND (NEWAY) 90557078 HOLLAND (NEWAY) 90557083 HOLLAND (NEWAY) 90557110 (PARALLEL ALIGNMENT) R & S TRUCK & BODY 1090023 RIDEWELL 1003589121C SAUER P50-733 REYCO 12882-02

⚠ WARNING: California Proposition 65 - Cancer and Reproductive Harm - www.P65Warnings.ca.gov.

D

SUSPENSION

Firestone

D

SUSPENSION

PART NO.	CROSS SECTION VIEW	BREAD PLATE TOP VIEW	BREAD PLATE BOTTOM VIEW	ASSY. WEIGHT (LBS)	REPLACES
TWD W01-358-9122				21.8	HENDRICKSON TRAILER S3467, S3830 HOLLAND (NEWAY) 90557020, 90557071, 90557076, 90557077 HENDRICKSON CAN. B-12514-008, B-12514-010 PORCUPINE REYCO 12883-02 SAUER P50-732 RIDEWELL 1003589122C TEMISKO WATSON & CHALIN
TWD W01-358-9144				24.2	HOLLAND (NEWAY) 90557155
TWD W01-358-9158				21.8	HENDRICKSON CAN. B-12514-004, B-12514-011 HOLLAND (NEWAY) 90557005 HENDRICKSON TRAILER S2063 HOLLAND (NEWAY) 90557069 PEERLESS RIDEWELL 1003589158C PORCUPINE MFG.SV.# NEWAY 90044197
TWD W01-358-9243				14.4	HOLLAND (NEWAY) 900557112 (AR90-[ALL]) (ARU92-9&10) WATSON & CHALIN AS-0061

⚠ WARNING: California Proposition 65 - Cancer and Reproductive Harm - www.P65Warnings.ca.gov.

Firestone

D
SUSPENSION

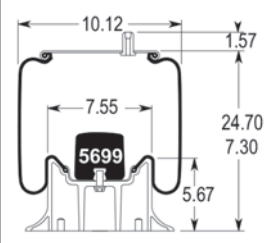
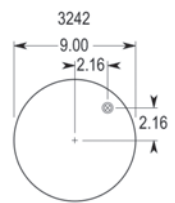
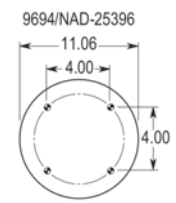
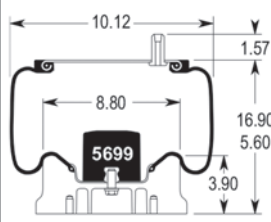
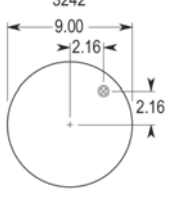
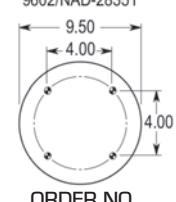
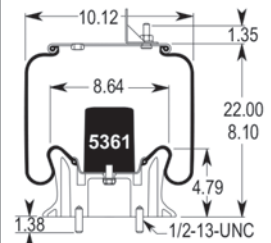
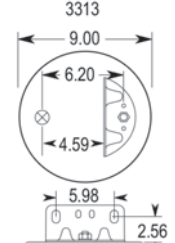
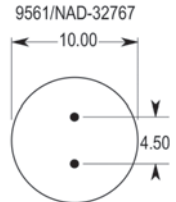
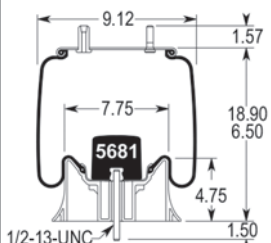
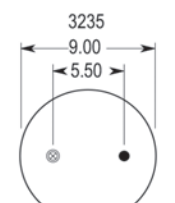
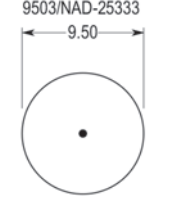
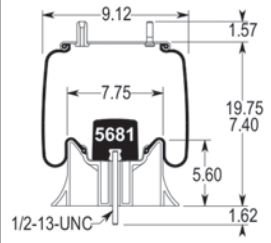
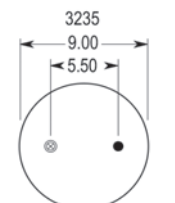
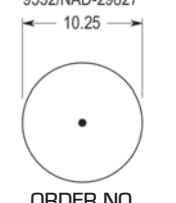
PART NO.	CROSS SECTION VIEW	BREAD PLATE TOP VIEW	BREAD PLATE BOTTOM VIEW	ASSY. WEIGHT (LBS)	REPLACES
TWD W01-358-9265 WILL BECOME 1T15MW-10			 ORDER NO. TWD WC1-358-1694	18.0	HENDRICKSON TRAILER S20124 HENDRICKSON TRAILER HT-250T HENDRICKSON TRAILER C20413 (ROTATE PISTON TO 45 ALIGNMENT) HENDRICKSON TRAILER HT-250U (ALL OTHERS) HENDRICKSON TRAILER HT-250U-Y (9Y-001)
TWD W01-358-9270 (WAS 1T15VM-4)			 ORDER NO. TWD WC1-358-1613	14.8	HENDRICKSON S-20010 (HT230T) REFS21208 W01-455-9579 (DIFFERENT BEAD PLATE) ALSO REPLACES 1T15VM-4.0
TWD W01-358-9287 BRACKET 70-3582-6042 NEW BRACKET 70-3583-6044			 ORDER NO. TWD WC1-358-1606	18.5	HENDRICKSON 50405-1&2 (FORD, W.STAR) HA-360/400/460 [1991-UP] HENDRICKSON 50405 (REMOVE INTERMEDIATE PLATE AND USE NEW PRODUCTION VERSION WITH BRACKET)
TWD W01-358-9293			 ORDER NO. TWD WC1-358-0666	12.9	HOLLAND (NEWAY) 90557120 (RL196-14, RL196A-14)
TWD W01-358-9295			 ORDER NO. TWD WC1-358-1619	13.2	HOLLAND (NEWAY) 90557121 (RL196-15 & 16) (RL196A-15 & 16)

⚠ WARNING: California Proposition 65 - Cancer and Reproductive Harm - www.P65Warnings.ca.gov.

Firestone



D

SUSPENSION

PART NO.	CROSS SECTION VIEW	BREAD PLATE TOP VIEW	BREAD PLATE BOTTOM VIEW	ASSY. WEIGHT (LBS)	REPLACES
TWD W01-358-9321			<p>96553/NBD-10437</p> <p>ORDER NO. TWD WC1-358-0620 ALUMINUM</p>	19.8	WATSON & CHALIN AS-0036
TWD W01-358-9366			<p>9549/NAD-29454</p> <p>ORDER NO. TWD WC1-358-1616</p>	11.8	HOLLAND (NEWAY) 90557160 HOLLAND (NEWAY) 90557210 HOLLAND (NEWAY) 90557225 WATSON & CHALIN AS-0054 WABASH HOLLAND (NEWAY) 90557225
TWD W01-358-9371			<p>9560/NAD-32768</p> <p>ORDER NO. TWD WC1-358-1620</p>	18.0	NAVISTAR 1670073C-1 NAVISTAR 1686386C-1 NAVISTAR 2027911C-1
TWD W01-358-9921			<p>9544/NAD-29826</p> <p>ORDER NO. TWD WC1-358-0666</p>	13.6	HOLLAND (NEWAY) 90557117 (AR92-12&14), (AR93-14) WATSON & CHALIN AS-0090 SILENT DRIVE

⚠ WARNING: California Proposition 65 - Cancer and Reproductive Harm - www.P65Warnings.ca.gov.

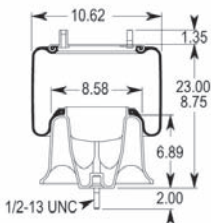
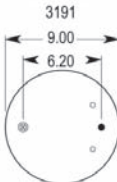
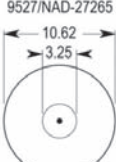
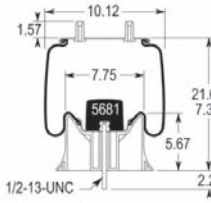
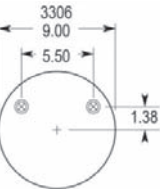
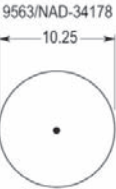
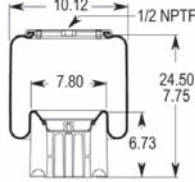
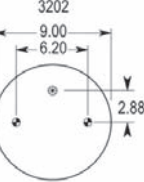
Firestone

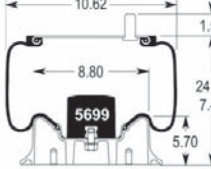
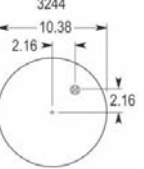
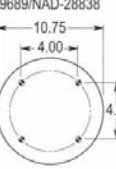
PART NO.	CROSS SECTION VIEW	BREAD PLATE TOP VIEW	BREAD PLATE BOTTOM VIEW	ASSY. WEIGHT (LBS)	REPLACES
TWD W01-358-9780			 <p>ORDER NO. TWD WC1-358-1627</p>	16.6	FREIGHTLINER 16-13810-000 (PLASTIC) FREIGHTLINER 681-320-0017 (ALUMINUM) SEE W01-358-9781 FREIGHTLINER PISTON 16-1673-000 (STEEL) SEE W01-358-9782
TWD W01-358-9974			 <p>ORDER NO. TWD WC1-358-0659</p>	14.3	AIR SPRING REPLACES HOLLAND (NEWAY) 90557332
TWD W01-358-8864			 <p>ORDER NO. TWD WC1-358-1626</p>	14.1	AIR SPRING REPLACES PETERBILT NUMBER:03-08716 (NEW LOW LEAF) SUPERSEDES 03-07887 EFFECTIVE 04/04 PACCAR PART
TWD W01-358-9580			 <p>ORDER NO. TWD WC1-358-1607</p>	18.9	AIR SPRING HENDRICKSON TRAILER NUMBER: S-20127/S-20414 HENDRICKSON TRAILER S20127 (HT-2500 9-006 HT-2500Y 9Y-006) REPLACES IT15VLT-10.5 IT15V-11 W01-358-9262

⚠ WARNING: California Proposition 65 - Cancer and Reproductive Harm - www.P65Warnings.ca.gov.

D
SUSPENSION





E

EXHAUST

EXHAUST & CLAMPS..... 184-189



E

EXHAUST

CLAMPS

PREFORMED SEAL CLAMPS

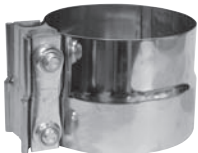
	PART NO.	DESCRIPTION
	TWD X007824	4" O.D., ALUMINUM
	TWD X007805	5" O.D., ALUMINUM

EASY SEAL CLAMPS

	PART NO.	DESCRIPTION
	TWD J000216	4" O.D., STAINLESS STEEL
	TWD J000217	5" O.D., STAINLESS STEEL

V-BAND CLAMP

	PART NO.	DESCRIPTION
	TWD P206607	5.88" DETROIT/CAT

TORCITE LAP JOINT CLAMPS

	PART NO.	DESCRIPTION
	TWD J009604	3" O.D., ALUMINIZED
	TWD J009605	3-1/2" O.D., ALUMINIZED
	TWD J009606	4" O.D., ALUMINIZED
	TWD J009607	5" O.D., ALUMINIZED
	TWD J009623	4" O.D., STAINLESS STEEL
	TWD J009624	5" O.D., STAINLESS STEEL

⚠ WARNING: California Proposition 65 - Cancer and Reproductive Harm - www.P65Warnings.ca.gov.



U-BOLT CLAMPS

STD. U-BOLT CLAMPS - DOUBLE, ROUND BAND

	PART NO.	DESCRIPTION
	TWD J000220	2" O.D., STEEL
	TWD J000221	2-1/2" O.D., STEEL
	TWD J000227	3" O.D., STEEL
	TWD J000230	4" O.D., STEEL
	TWD J000232	5" O.D., STEEL

STD. U-BOLT CLAMPS - DOUBLE, FLAT BAND

	PART NO.	DESCRIPTION
	TWD P206600	3" O.D., ZINC
	TWD P206602	4" O.D., ZINC
	TWD P206603	5" O.D., ZINC
	TWD P206611	5" O.D., CHROME

STD. U-BOLT CLAMPS - SINGLE, ROUND BAND

	PART NO.	DESCRIPTION
	TWD P206409	3-1/2" O.D., STEEL
	TWD P206410	4" O.D., STEEL
	TWD P206411	5" O.D., STEEL

WARNING: California Proposition 65 - Cancer and Reproductive Harm - www.P65Warnings.ca.gov.

BANDS

FLAT BANDS / SEAL CLAMPS

	PART NO.	DESCRIPTION
	TWD X004476	2-1/2" O.D., STAINLESS STEEL
	TWD X004478	3" O.D., STAINLESS STEEL
	TWD X004480	3-1/2" O.D., STAINLESS STEEL
	TWD X004482	4" O.D., STAINLESS STEEL
	TWD X004484	5" O.D., STAINLESS STEEL
	TWD X006203	4" O.D., ALUMINUM
	TWD X006202	5" O.D., ALUMINUM

WARNING: California Proposition 65 - Cancer and Reproductive Harm - www.P65Warnings.ca.gov.



EXHAUST



E

EXHAUST

CONNECTORS

STANDARD CUT - FLEX CONNECTOR

	PART NO.	DESCRIPTION
	TWD J034744	5" I.D. X 36" LG.

CONNECTORS

	PART NO.	DESCRIPTION
	TWD P206374	4" I.D. X 6"
	TWD P206375	5" I.D. X 6"

⚠ WARNING: California Proposition 65 - Cancer and Reproductive Harm - www.P65Warnings.ca.gov.

TUBING

FLEX TUBING

	PART NO.	DESCRIPTION
	TWD P226148	2" I.D. X 10 FT, GALVANIZED
	TWD P226141	3-1/2" I.D. X 10 FT, GALVANIZED
	TWD P226142	4" I.D. X 10 FT, GALVANIZED
	TWD P226155	4" I.D. X 25 FT, GALVANIZED
	TWD P226143	5" I.D. X 10 FT, GALVANIZED
	TWD P226157	5" I.D. X 25 FT, GALVANIZED
	TWD P226145	3-1/2" I.D. X 10 FT, STAINLESS STEEL
	TWD P226146	4" I.D. X 10 FT, STAINLESS STEEL
	TWD P226147	5" I.D. X 10 FT, STAINLESS STEEL
	TWD P226158	5" I.D. X 25 FT, STAINLESS STEEL

⚠ WARNING: California Proposition 65 - Cancer and Reproductive Harm - www.P65Warnings.ca.gov.



TUBING (continued)

EXHAUST TUBES

	PART NO.	DESCRIPTION
	TWD P206334	3" O.D. X 10 FT, ALUMINUM
	TWD P206335	3-1/2" O.D. X 10 FT, ALUMINUM
	TWD P206336	4" O.D. X 10 FT, ALUMINUM
	TWD P206337	5" O.D. X 10 FT, ALUMINUM

⚠ WARNING: California Proposition 65 - Cancer and Reproductive Harm - www.P65Warnings.ca.gov.

ALUMINIZED ELBOWS

ALUMINIZED 90° ELBOWS (O.D. - I.D.)

	PART NO.	DIA.	A	B	R
	TWD P206340	3"	8"	8"	5"
	TWD P206342	3-1/2"	9"	9"	5"
	TWD J008681	4"	8"	8"	5"
	TWD P206344	4"	10"	10"	8"
	TWD J190003	5"	8-1/2"	8-1/2"	5-1/2"
	TWD P207339	5"	11"	11"	5-1/2"
	TWD P206347	5"	15"	15"	10"
	TWD P207341	6"	15"	15"	10"

ALUMINIZED 90° ELBOWS (O.D. - O.D.)

	PART NO.	DIA.	A	B	R
	TWD P207364 (SHORT RADIUS)	4"	8"	8"	4"
	TWD P207365 (SHORT RADIUS)	5"	10"	10"	5-1/2"
	TWD P207366 (SHORT RADIUS)	6"	10"	10"	6"
	TWD P206346	4"	12"	12"	4"
	TWD P207331	5"	—	—	10"
	TWD P207332	5"	11"	16"	5-1/2"
	TWD P206400	5"	5-1/2"	5-1/2"	5-1/2"

⚠ WARNING: California Proposition 65 - Cancer and Reproductive Harm - www.P65Warnings.ca.gov.

E

EXHAUST



ALUMINIZED ELBOWS (continued)

ALUMINIZED 45° ELBOWS (O.D. - I.D.)

	PART NO.	DIA.	A	B	R
	TWD P206282	4"	9-1/4"	9-1/4"	8"
	TWD J190025	5"	8"	8"	8"
	TWD P206283	5"	12"	12"	8"

ALUMINIZED 45° ELBOWS (O.D. - O.D.)

	PART NO.	DIA.	A	B	R
	TWD P207353	4"	8"	8"	4"
	TWD P207354	5"	8"	8"	5-1/2"

⚠ WARNING: California Proposition 65 - Cancer and Reproductive Harm - www.P65Warnings.ca.gov.

MISCELLANEOUS

LIP FLANGE

	PART NO.	DESCRIPTION
	TWD P206615	5" I.D., 5.69" O.D. X 3"

⚠ WARNING: California Proposition 65 - Cancer and Reproductive Harm - www.P65Warnings.ca.gov.

E

EXHAUST



MISCELLANEOUS (continued)

PIPES

	PART NO.	DESCRIPTION
	TWD P207297	TAIL PIPE, 4" I.D. X 18", ALUMINUM
	TWD P208375	STACK PIPE, 5" O.D. X 36", CHROME
	TWD P206387	STACK PIPE, 5" O.D. X 48", CHROME
	TWD P208395	STACK PIPE, 5" O.D. X 60", CHROME

STACK CAPS

	PART NO.	DESCRIPTION
	TWD P270539	4" O.D., ZINC PLATED
	TWD P270541	5" O.D., ZINC PLATED

⚠ WARNING: California Proposition 65 - Cancer and Reproductive Harm - www.P65Warnings.ca.gov.

MUFFLERS & CLAMPS

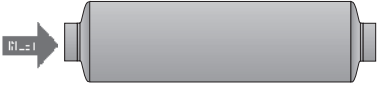
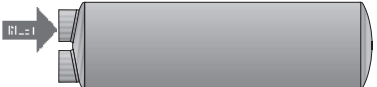
MUFFLER	DONALDSON	WALKER	NELSON	TRUCKEX
	TWD M100463	22920	86130M	3640
	TWD M090594	21171	86560M	3888
	TWD M090544	22936	86108M	3891
	TWD M120450	22971	4205	N/A

STEPPED SEAL CLAMP™	DONALDSON
3.5"	TWD X007831

⚠ WARNING: California Proposition 65 - Cancer and Reproductive Harm - www.P65Warnings.ca.gov.

E

EXHAUST





F

FILTRATION

ON-HIGHWAY 192-197
HARD PARTS & ACCESSORIES 197-198
DIESEL EXHAUST FLUID CAPS 199



Innovative Filtration Solutions for Engines, Equipment and the People Who Use Them

- Industry-shaping technology – uncompromising product quality
- Trusted by OE's – preferred by the pro's
- Broad Distribution Network – customers buy where they prefer
- Broad Product Coverage – air, lube, fuel, coolant and hydraulic filters and systems, plus exhaust, accessories and more
- Tremendous Value – the best filtration solutions for the money
- Consistent Product Availability – the filters you need, when you need them
- Specialized Fleet Service – for the trucking industry
- Comprehensive Customer Service – by experienced and knowledgeable sales and technical support
- Easy-To-Use e-Tools
- Warranty – comprehensive coverage and far-reaching field support
- Global presence with a local touch

F

FILTRATION

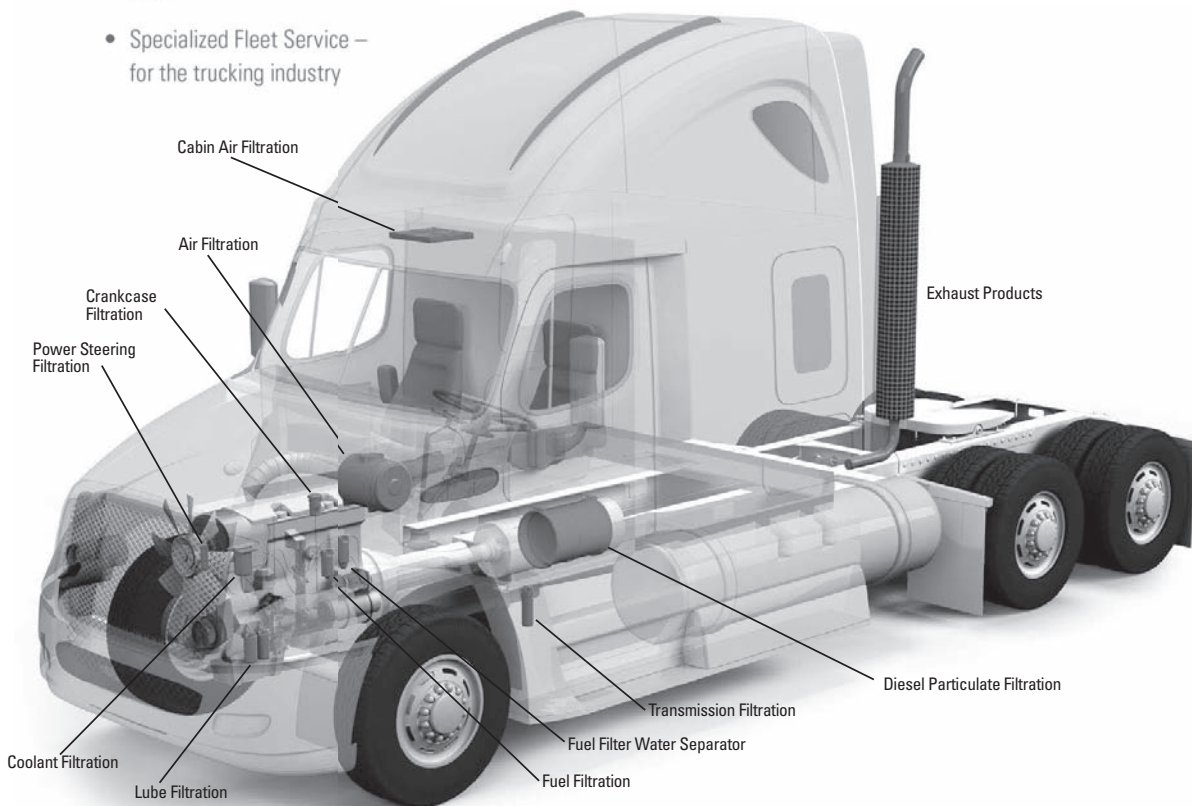



Your Total System Supplier

Count on Donaldson to have the right filters, mufflers and accessories for your engines and equipment. Our filtration solutions optimize on-road performance and reduce maintenance costs.

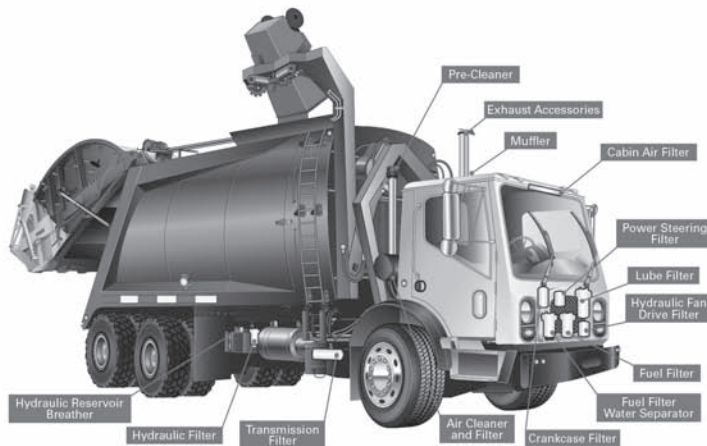
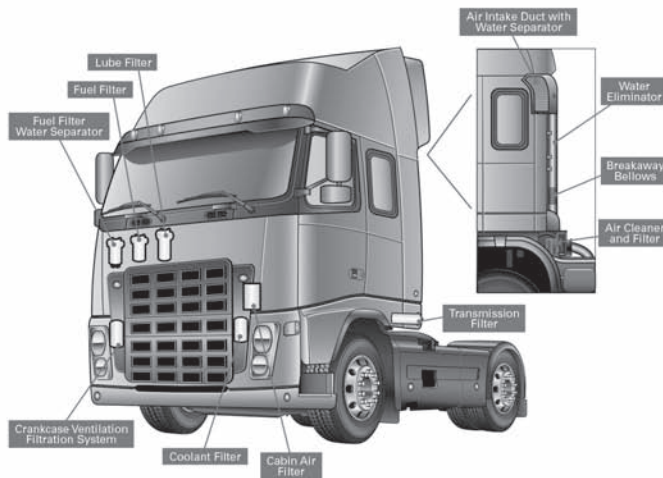
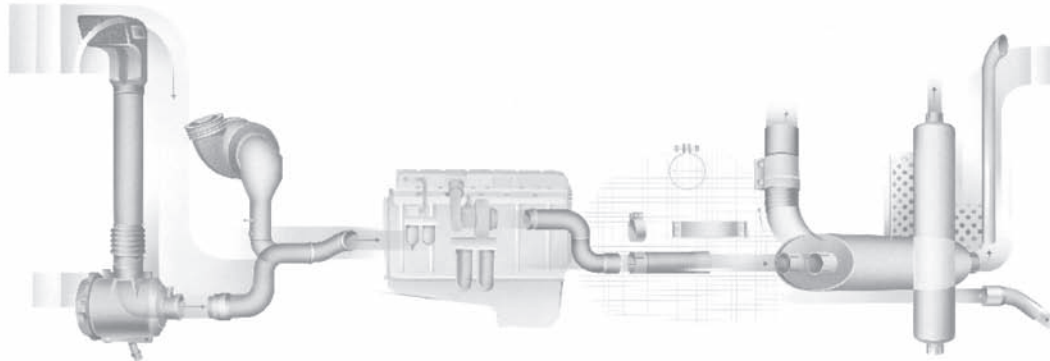

Complete Coverage From End to End

Induction to Exhaust Venting

- Air cleaners and replacement filters
- Fuel filters
- Lube filters
- Hydraulic and transmission filters and accessories
- Donaldson Blue™ extended service air, lube and coolant products
- Coolant filters and additive replenishment technology
- Air intake accessories – such as rain caps, rubber elbows and connectors, Vacuator™ Valves, stack extensions
- Mufflers
- Exhaust accessories – such as clamps and connectors, flex and straight tubing, elbows

Ask your Donaldson distributor or dealer for more information about our full line of filtration products and accessories.



FILTRATION



Filtration Products for On-Road Trucking Applications



Fuel Filtration

Donaldson filters help prevent injector damage by delivering clean fuel to your engine. They're a better way to filter fuel.



Fuel filters protect engine components and help extend equipment life.



Donaldson Blue® fuel filters for Cummins® ISX engines deliver the cleanest fuel to your injectors, pumps and engines.

Cummins® is a registered trademark of Cummins Inc. Racor® is a registered trademark of Parker Hannifin Corporation. DAVCO®, Fuel Pro® and EleMax® are registered trademarks of DAVCO Technology, LLC.



Racor® fuel systems Choose the filter system that you prefer – Twist&Drain™ or OEM style filters.



DAVCO® Fuel Pro® Replacement filters for DAVCO® Fuel Pro® 380/382 and 482/483 EleMax® Fuel Processors.

FILTRATION



Lube Filtration

Donaldson lube filters keep oil clean by capturing contaminants that can cause engine damage.

Donaldson
BLUE



Lube filters capture metals, soot and contaminants to maintain higher cleanliness standards.



Coolant Filtration

Donaldson coolant filters remove contaminants and maintain cooling system balance.



Coolant filters help keep hot-running engines cool and reduce downtime.

Donaldson
BLUE



Air Filtration

Today's high performance engines and tougher emissions standards demand higher-performing air intake systems.



Air cleaners

Since 1915, Donaldson has pioneered the development of nearly every major advancement in heavy-duty engine air filtration. Nothing else performs like our industry-leading air cleaners.

Donaldson
BLUE



Replacement filters deliver better protection with Donaldson Blue® filters or PowerCore® filtration technology.



Fleetguard® OptiAir™ and Mann+Hummel® Europiclon® Air Cleaners

Donaldson's line of replacement filters for OptiAir and Europiclon air cleaners utilize high-efficiency media, vibration resistant RadialSeal™ design and rigid structural support to deliver complete engine protection.

Fleetguard® and OptiAir™ are registered trademarks of Cummins, Inc. Mann+Hummel® and Europiclon® are registered trademarks of Mann+Hummel®.



Filtration Products for On-Road Trucking Applications



Hydraulic and Transmission Filtration

Performance under **any** pressure.



Low Pressure are rated for working pressures up to 350 psi, with in-tank and in-line configurations available.



Medium Pressure Duramax filters have become the industry standard for operating pressures up to 2000 psi.



T.R.A.P.™ Breathers collect and expel moisture from hydraulic and lube reservoirs – they also prevent particulate from entering.



Clean Diesel Filter Kits

Easy to install on any fuel dispenser. Ready to filter out the finest contaminants before they enter your equipment's fuel system.



Basic Kit includes single head, high efficiency diesel filter and pressure gauge.



High Capacity Kit includes dual head, high efficiency diesel filters (2), pressure gauge and flange adaptors.



Clean & Dry Kit includes single head (2), high efficiency diesel filter, water absorbing filter, pressure gauge (2) and T.R.A.P. breather.



Exhaust & Emissions

Trusted supplier of exhaust and emissions systems, components, and accessories that protect your equipment.



Mufflers, clamps, and accessories for medium- and heavy-duty diesel powered equipment.

Diesel Particulate Filters (DPFs) provide optimal exhaust flow and reduced backpressure on engines.



Donaldson BLUE

With pioneering technology – **Synteq™** and **Synteq XP™** media for liquid filters and **Ultra-Web®** media for air filters – **Donaldson Blue** filters trap higher volumes of fine contaminant while protecting engines and equipment, extending service intervals and reducing downtime.



Donaldson Blue Fuel filters with Synteq XP™ nanofiber media deliver the cleanest fuel – providing better protection for your injectors. Tests have proven that they deliver fuel that is four times cleaner than competitors' best filters.



Donaldson Blue Lube filters with Synteq™ media deliver extended service intervals, improved lubricant flow, improved cold start performance and a higher level of protection to prolong engine and equipment life.



Donaldson Blue Coolant filters allow you to extend filter life while maintaining coolant condition. Options with additive replenishment technology allow you to extend your maintenance intervals up to once a year or 150,000 miles.

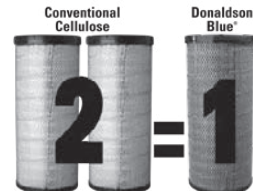

Donaldson Blue Air Filters with Ultra-Web® Nanofiber media allow you to go *Twice the Distance* between service. Durable, robust and designed to perform in extreme temperature and humidity conditions; high capacity/high efficiency.



FILTRATION



POPULAR FILTER PRODUCTS FOR ON-ROAD TRUCKS

PRODUCT DESCRIPTION	PRIMARY APPLICATION	DONALDSON	BALDWIN	FLEETGUARD	FRAM	LUBER-FINER	WIX
Air Primary	Freightliner	TWD P153551	TWD PA2705	AF1968M	CA3990	LAF3551	46883
	Freightliner FL Series	TWD P142100	TWD PA2631	AF1817M	CA6326	LAF2100	46860
Air Primary PowerCore®	Ford F-Series Super Duty 6.0L Diesel	TWD P603577	TWD CA4999	AF26152	CA9516	LAF1646	42731
	Freightliner M2 Series	TWD P607955	TWD CA4700	AF26154	CA10281	LAF3323	42809
	GMC Silverado, Sierra 6.6L Duramax Diesel	TWD P610875	TWD CA5352	AF27860	CA10161	LAF2947	49184
Air Primary Radialseal®	Freightliner Century Class/ Columbia	TWD P527682	TWD RS3518	AF25139M	CA7140	LAF1849	46556
	Freightliner FL Series	TWD P532966	TWD RS3517	AF25223	CH8193	LAF4498	46842
	Hino 238	TWD P527484	TWD RS2863	AF4878	CA7139	LAF1878	46433
	Kenworth & Peterbilt	TWD P534816	TWD RS3539	AF25247	CA8180	LAF4816	46843
	Kenworth & Peterbilt	TWD P534925	TWD RS3534	AF25248	CA8231	LAF3302	46863
	Navistar 9900i	TWD P539765	TWD RS3743	AF25694	CA10768	LAF9540	46507
	Refrigeration Units	TWD P822686	TWD RS3715	AF25550	CA9248	LAF8388	46449
Air Safety	Volvo VN Series	TWD P606720	TWD RS4642	AF26472M	CA9901	LAF9201	49126
	Freightliner M2 Series	TWD P616400	TWD PA4701	AF27706	CA10281SY	LAF3234	49910
Coolant Spin-On	Cummins 3315116 (4 units of SCA+)	TWD P552071	TWD BW5071	WF2071	PR3908	-	24071
	Cummins 3315116 (4 units of SCA)	TWD P554071	TWD BW5136	WF2051	PR3304	LFW4071	24030
FFWS Cartridge	Davco 380/382	TWD P550463	TWD PF7680	FF5369W	C8017	L3578F	33651
	Davco 380/382 Elemax	TWD P550467	TWD PF7748	FS19613	-	-	-
FFWS Spin-On	Cummins Celect	TWD P551000	TWD BF1259	FF1000	PS8048	LFF1000	33406
Fuel Spin-On Primary	Caterpillar Engines	TWD P551311	TWD BF7587	FF5319	P8335	LFF2749	33674
	Detroit Series 60	TWD P556915	TWD BF5800	FF5207	P1146G	LFP815FN	33118
	Volvo 20430751	TWD P550529	TWD BF7814	FF5507	P9626	LFF8059	33721
	Volvo 243004	TWD P553004	TWD BF988	FF5018	P4102	FP586F	33358
Fuel Spin-On Secondary	Cummins ISM, ISX	TWD P552200	TWD BF7766	FF2200	-	LFF2201	33711
Lube Cartridge	Mack E7	TWD P552231	TWD BC7242	CS41011	P9520	LP3985	57703
Lube Cartridge Full Flow	Mercedes MBE4000	TWD P550769	TWD P7230	LF16046	CH9558	LP8995	57213
Lube Spin On Bypass	Volvo 4775565	TWD P550425	TWD B7685	LF3654	P9407	LFP8642	51660
Lube Spin-On Combination	Cummins Engines	TWD P553000	TWD BD103	LF3000	HPH6349	LFP3000	51748
Lube Spin-On Full Flow	Caterpillar Engines	TWD P554005	TWD B99	LF691A	PH3335	LFP4005	51792
	Cummins ISB	TWD P550428	TWD BT595	LF3970	PH8942	LFP3970	57182
	Cummins ISM, ISX	TWD P559000	TWD BD7153	LF9000	PH8690	LFP9001	57745
	Detroit Series 60	TWD P552100	TWD B495	LF3620	PH7405	LFP2160	51971
	Refrigeration Units	TWD P502067	TWD B1400	LF3925	PH6607	PH2876	51365

F

FILTRATION

⚠ WARNING: California Proposition 65 - Cancer and Reproductive Harm - www.P65Warnings.ca.gov.







EXTENDED SERVICE DONALDSON BLUE™ CROSS REFERENCE TO STANDARD DONALDSON FILTERS

PRODUCT DESCRIPTION	STANDARD	DONALDSON BLUE™
LUBE SPIN-ON FULL FLOW	-	TWD DBL3998
	-	TWD DBL7900
	TWD P558616	-
AIR PRIMARY, ULTRA-WEB®	TWD P181015	-

⚠ WARNING: California Proposition 65 - Cancer and Reproductive Harm - www.P65Warnings.ca.gov.

HARD PARTS & ACCESSORIES





	PART NO.	PRODUCT TYPE	PRODUCT DETAILS	PRODUCT FEATURES
	TWD C105017	ECC DuraLite™ Air Cleaner	10.50"	<ul style="list-style-type: none"> • Disposable, Rugged Air Cleaner For Small Or High Pulsation Gas And Diesel Engines • Can Be Mounted Vertically Or Horizontally
	TWD G112404	ECG Konepac™ Air Cleaner	11"	<ul style="list-style-type: none"> • High Airflow In Compact Size For Horizontal Installation With Side Inlet • Latched Service Access
	TWD G150048	EPG Air Cleaner	15" RADIAL SEAL	<ul style="list-style-type: none"> • Improved Reliability, Superior Engine Protection, Easiest Serviceability • Can Be Mounted Vertically Or Horizontally
	TWD H001251	Full-View Pre-Cleaner	2.5" O.D.	<ul style="list-style-type: none"> • Extends Primary Air Filter Life In Heavy Dust Environments • Full-View Plastic Bowl Lets Operator Easily See When Service Is Needed
	TWD H002436	TopSpin™ Pre-Cleaner	2.53" I.D.	<ul style="list-style-type: none"> • Extends Primary Air Filter Life In Heavy Dust Environments • Self-Cleaning / Self Scavenging

⚠ WARNING: California Proposition 65 - Cancer and Reproductive Harm - www.P65Warnings.ca.gov.

F
FILTRATION



HARD PARTS & ACCESSORIES (continued)

	PART NO.	PRODUCT TYPE	PRODUCT DETAILS	PRODUCT FEATURES
	TWD P007191	Air Cleaner Mounting Band	6.5" I.D.	<ul style="list-style-type: none"> Durable, Corrosion Resistant, Steel Construction Fully Engineered And Tested To Resist The Adverse Effects Of Vibration
	TWD P107844	90° Rubber Elbow	5" I.D.	<ul style="list-style-type: none"> Absorbs Vibration And Resists Tears, Puncture And Vacuum Collapse Reduce Intake Noise Levels Under Severe Conditions
	TWD P525956	Vacuator™ Valve	1"	<ul style="list-style-type: none"> Automatically Expels Dust And Water With Normal Engine Pulsing
			EPG Radial Seal	<ul style="list-style-type: none"> Unloads When The Engine Is Stopped
	TWD X002277	The Informer™	25" H2O/5 KPA	<ul style="list-style-type: none"> Graduated, Continuous Readings Whether Engine Is Running Or Shut Down
	TWD X002278	Filter Service Indicator	20" H2O/5 KPA	<ul style="list-style-type: none"> Provides A Continuous Data Reading Whether Engine Is Running Or Shut Down
	TWD P564669	T.R.A.P.™ Hydraulic Reservoir Breather	1" NPT	<ul style="list-style-type: none"> Extends Life By Exhaling Moisture And Refreshing Its Holding Capacity On Each Cycle
			Bulk Fluid Storage Tanks	<ul style="list-style-type: none"> Thermally Reactive Barrier That Removes Moisture At Relative Humidity Levels As Low As 15%

⚠ WARNING: California Proposition 65 - Cancer and Reproductive Harm - www.P65Warnings.ca.gov.

F

FILTRATION



DEF CAPS

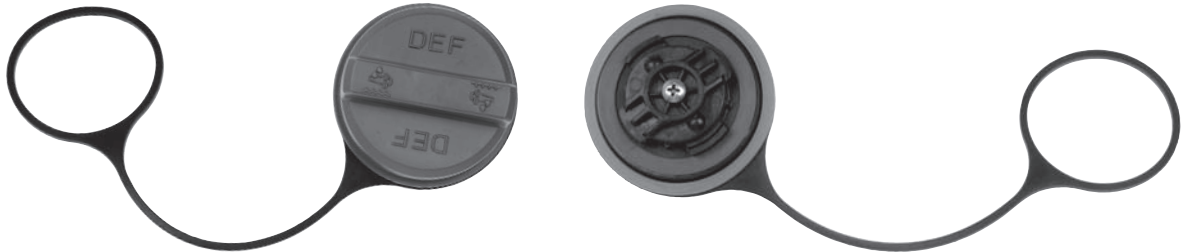

F

FILTRATION

PART NO.	OEM	MAKE	MODEL	YEARS
NHD 1119010	04-27757-000	FREIGHTLINER	ALL MED AND HEAVY DUTY TRUCKS	2012-10
NHD 1119011	AU5Z5K204A	FORD	ALL LIGHT AND MED DUTY TRUCKS	2012-10
NHD 1119012	908-0223-01	KENWORTH - PETERBILT	ALL PETERBILT AND KENWORTH	2012-10
NHD 1119013	21148728	MACK	ALL MACK TRUCKS	2012-10
NHD 1119014	21148725	VOLVO	ALL VOLVO TRUCKS	2012-10
NHD 1119015	22753134	GMC	ALL LIGHT AND MED DUTY TRUCKS	2012-10
NHD 1119016	8-98120-262-1	ISUZU	ALL LIGHT AND MED DUTY TRUCKS	2012-10
NHD 1119017	52122496AD	DODGE	ALL DODGE MED AND HEAVY DUTY TRUCKS	2012-10

⚠ WARNING: California Proposition 65 - Cancer and Reproductive Harm - www.P65Warnings.ca.gov.





G

DRIVE SYSTEMS

HYDRAULIC VALVES & ACCESSORIES 202-203

HYDRAULIC RESERVOIRS 203

DRIVELINE & COMPONENTS 204-211



Quality since 1946

VALVES

	PART NO.	DESCRIPTION
	TWD BAV050SA	AIR VALVE W/SOLENOID (ONLY) <ul style="list-style-type: none"> • 4-WAY, 2-POSITION SOLENOID VALVE • 5 PORT (1/4" N.P.T.), 4-WAY, 2-POSITION SOLENOID VALVE
	TWD K90D	P.T.O./PUMP VALVE <ul style="list-style-type: none"> • VALVE W/SPRING RETURN RAISE (DEAD MAN CONTROL)

⚠ WARNING: California Proposition 65 - Cancer and Reproductive Harm - www.P65Warnings.ca.gov.

TAILGATE ACCESSORIES

	PART NO.	DESCRIPTION
	TWD TGL3410ST	STEEL TAILGATE LATCH ASSEMBLY W/FORGED BRACKET & CLEVIS
	TWD TGL34SBR	STEEL LATCH ASSEMBLY FOR TAILGATE LATCH

⚠ WARNING: California Proposition 65 - Cancer and Reproductive Harm - www.P65Warnings.ca.gov.

CONTROL CABLE

	PART NO.	DESCRIPTION
	TWD VCGTX06	<ul style="list-style-type: none"> • 6' VERNIER HEAVY-DUTY ADJUSTABLE LOCKING CONTROL CABLE • .088 DIA. STAINLESS STEEL CORE
	TWD VCGTX10	<ul style="list-style-type: none"> • 10' VERNIER HEAVY-DUTY ADJUSTABLE LOCKING CONTROL CABLE • .088 DIA. STAINLESS STEEL CORE
	TWD VCGTX15	<ul style="list-style-type: none"> • 15' VERNIER HEAVY-DUTY ADJUSTABLE LOCKING CONTROL CABLE • .088 DIA. STAINLESS STEEL CORE

⚠ WARNING: California Proposition 65 - Cancer and Reproductive Harm - www.P65Warnings.ca.gov.





ROD END BEARING WITH STUD

	PART NO.	DESCRIPTION
	TWD BRE52S	1/4-28 UNF-2
	TWD BRE62S	5/16-24 UNF-2
	TWD BRE72S	3/8-24 UNF-2

⚠ WARNING: California Proposition 65 - Cancer and Reproductive Harm - www.P65Warnings.ca.gov.

HYDRAULIC RESERVOIRS

	PART NO.	DESCRIPTION
	TWD SMC50A	50 GALLON ALUMINUM RESERVOIR
	TWD SMR15S	15 GALLON RESERVOIR

⚠ WARNING: California Proposition 65 - Cancer and Reproductive Harm - www.P65Warnings.ca.gov.



DRIVE SYSTEMS



DRIVELINE PROGRAM PARTS



TWD HD210140-1X



TWD HD2-2-329



TWD HD5-178X

DRIVE SYSTEMS

PART NO.	DESCRIPTION	WEIGHT	CROSS REFERENCE		
			SPICER	NEAPCO	MERITOR
TWD HD210140-1X	1480 HANGER BEARING	3.0 LBS	210140-1X	N210140-1X	GCB210140-1X
TWD HD210207-1X	1550 HANGER BEARING	3.0 LBS	210207-1X	N210207-1X	GCB210207-1X
TWD HD210370-1X	1310/1350 HANGER BEARING	2.5 LBS	210370-1X	N210370-1X	GCB210370-1X
TWD HD210391-1X	1410/1550 HANGER BEARING	2.5 LBS	210391-1X	N210391-1X	GCB210391-1X
TWD HD210433-1X	1410/1480 HANGER BEARING	4.0 LBS	210433-1X	N210433-1X	GCB210433-1X
TWD HD210661-1X	1710/SPL250 HANGER BEARING	7.5 LBS	210661-1X	N210661-1X	GCB210661-1X
TWD HD210866-1X	1310/1480 HANGER BEARING	3.5 LBS	210866-1X	N210866-1X	GCB210866-1X
TWD HD2-2-329	1310 FLANGE YOKE	1.0 LB	2-2-329	N2-2-329	131N-2-239
TWD HD2-2-479	1310 FLANGE YOKE	1.0 LB	2-2-479	N2-2-479	131N-2-479
TWD HD2-4-503	1310 S/R END YOKE	1.5 LB	2-4-503	N2-4-503	131N-4-503
TWD HD2-4-533	1310 S/R END YOKE	1.5 LB	2-4-533	N2-4-533	131N-4-533
TWD HD5-1203X	1330/P55 U-JOINT KIT	1.25 LB	5-1203X	2-4800	CP213X
TWD HD5-129X	1240AG U-JOINT KIT	1.1 LB	5-129X	1-2075	GCP129X
TWD HD5-1306X	7260 U-JOINT ASSEMBLY	1.1 LB	5-1306X	1-6301	CP1306X
TWD HD5-134X	1310/1330 U-JOINT ASSEMBLY	1.25 LB	5-134X	1-0134	CP134X
TWD HD5-153X	1310 U-JOINT ASSEMBLY	1.0 LB	5-153X	1-0153	CP153X
TWD HD5-155X	1550 U-JOINT KIT	3.18 LBS	5-155X	3-0155	CP155X
TWD HD5-160X	1410 U-JOINT KIT	1.88 LB	5-160X	2-0054	CP160X
TWD HD5-170X	1000 U-JOINT ASSEMBLY	0.75 LB	5-170X	1-0170	CP170X
TWD HD5-178X	1350 U-JOINT KIT	1.63 LB	5-178X	2-0053	CP178X
TWD HD5-188X	1480 U-JOINT KIT	2.75 LBS	5-188X	3-0188	CP188X
TWD HD5-213X	1330 U-JOINT ASSEMBLY	1.25 LB	5-213X	2-4800	CP213X
TWD HD5-242X	1140AG U-JOINT ASSEMBLY	1.0 LB	5-242X	1-1275	GCP242X
TWD HD5-243X	1340AG U-JOINT KIT	1.5 LB	5-243X	2-2275	GCP243X
TWD HD5-279X	1610 U-JOINT KIT	5.95 LBS	5-279X	4-0279	R279X
TWD HD5-280X	1710 U-JOINT KIT	8.0 LBS	5-280X	5-0280	R280X
TWD HD5-281X	1810 U-JOINT KIT	10.5 LBS	5-281X	6-0281	CP3022X
TWD HD5-3022X	1310/S44 U-JOINT KIT	1.25 LB	5-300X	3-3130	GCP308X
TWD HD5-308X	1880 U-JOINT KIT	15.0 LBS	5-308X	-	CP3147X
TWD HD5-3147X	3R U-JOINT ASSEMBLY	1.37 LB	5-3147X	2-3011	CP18N96
TWD HD5-324X	1810/92N U-JOINT KIT	13.55 LBS	5-324X	6-0324	GCP326X
TWD HD5-326X	1880/9C U-JOINT KIT	16.0 LBS	5-326X	-	R407X

⚠ WARNING: California Proposition 65 - Cancer and Reproductive Harm - www.P65Warnings.ca.gov.



DRIVELINE PROGRAM PARTS (continued)

PART NO.	DESCRIPTION	WEIGHT	CROSS REFERENCE		
			SPICER	NEAPCO	MERITOR
TWD HD5-407X	1760 U-JOINT KIT	9.25 LBS	5-407X	6-0407	CP62N-HB
TWD HD5-6102X	6C/CP62N JNT UNIV. (2LWT, 2HWD)	5.25 LBS	5-6102X	4-6114	CP62N-HWD
TWD HD5-6106X	6C U-JOINT KIT (HWD)	5.51 LBS	5-6106X	4-6128	R674X
TWD HD5-674X	1610 H/R U-JOINT W/STRAPS	6.0 LBS	5-674X	6-0674	R676X
TWD HD5-675X	1710 H/R U-JOINT W/STRAPS	7.75 LBS	5-675X	6-0675	R675X
TWD HD5-676X	1810 H/R U-JOINT W/STRAPS	10.25 LBS	5-676X	6-0676	R677X
TWD HD5-677X	1760 H/R U-JOINT W/STRAPS	9.26 LBS	5-677X	6-0677	CP72N-DWT
TWD HD5-7000X	7C H/R U-JOINT (4 LWT) DWT	6.83 LBS	5-7000X	5-7205	CP72N-HWD
TWD HD5-7105X	7LN U-JOINT (4 HWD)	8.17 LBS	5-7105X	5-7126	CP72N-HB
TWD HD5-7202X	7C U-JOINT (2 DWT 2 HWD)	7.75 LBS	5-7202X	5-7207	CP82N-HWD
TWD HD5-8105X	8C U-JOINT (4 HWD)	11.75 LBS	5-8105X	6-8113	CP92N-HWD
TWD HD5-9001X	9C U-JOINT (4 HWD)	18.0 LBS	5-9001X	-	17N-28-347
TWD HD6-28-347	1710 TUBE CYOKE	10.0 LBS	6-28-347	N6-28-347	17N-3-2651KX
TWD HD6-40-521	1710/1760 SLIP STUB SHAFT	14.5 LBS	6-40-521	N6-40-521	RPL170
TWD HDS170X	U-JOINT KIT NO H/W	8.0 LBS	SPL170X	-	-
TWD HDS250X	U-JOINT KIT NO H/W	13.0 LBS	SPL250X	-	-
TWD HDS90X	U-JOINT KIT WITH HARDWARE	6.25 LBS	SPL90X	-	-

⚠ WARNING: California Proposition 65 - Cancer and Reproductive Harm - www.P65Warnings.ca.gov.

G
DRIVE SYSTEMS



MXL U-JOINTS



PART NO.	DESCRIPTION
TWD M280X	1710 FULL-ROUND
TWD M281X	1810 FULL-ROUND
TWD M407X	1760 FULL-ROUND
TWD M675X	1710 HALF-ROUND
TWD M676X	1810 HALF-ROUND
TWD M677X	1760 HALF-ROUND

⚠ WARNING: California Proposition 65 - Cancer and Reproductive Harm - www.P65Warnings.ca.gov.



MERITOR

DUAL U-JOINTS

	PART NO.	DESCRIPTION
	TWD US170X	BEARING DIAMETER 2.165"
	TWD US250X	BEARING DIAMETER 2.361"

⚠ WARNING: California Proposition 65 - Cancer and Reproductive Harm - www.P65Warnings.ca.gov.

SUPPORT BRACKET

	PART NO.	DESCRIPTION
	TWD CB2106611XSA	CENTER BEARING IDEAL FOR THE MOST POPULAR HEAVY DUTY TRUCK AND TRACTOR APPLICATIONS

⚠ WARNING: California Proposition 65 - Cancer and Reproductive Harm - www.P65Warnings.ca.gov.



U-JOINTS

	PART NO.	DESCRIPTION
	TWD 1-0153	UNIVERSAL JOINT

⚠ WARNING: California Proposition 65 - Cancer and Reproductive Harm - www.P65Warnings.ca.gov.

G

DRIVE SYSTEMS



U-JOINTS WITH STRAPS



PART NO.	DESCRIPTION
TWD 5-674X	1610 H/R U-JOINT W/ STRAPS
TWD 5-675X	1710 H/R U-JOINT W/STRAPS
TWD 5-676X	1810 H/R U-JOINT W/STRAPS
TWD 5-677X	1760 H/R U-JOINT W/STRAPS

⚠ WARNING: California Proposition 65 - Cancer and Reproductive Harm - www.P65Warnings.ca.gov.

U-JOINT KITS & ASSEMBLIES



PART NO.	DESCRIPTION
TWD 5-103X	100SG U-JOINT KIT
TWD 5-153X	1310 U-JOINT ASSEMBLY
TWD 5-155X	1550 U-JOINT KIT
TWD 5-160X	1410 U-JOINT KIT
TWD 5-170X	1000 U-JOINT ASSEMBLY
TWD 5-178X	1350 U-JOINT KIT
TWD 5-188X	1480 U-JOINT KIT
TWD 5-213X	1330 U-JOINT ASSEMBLY
TWD 5-279X	1610 U-JOINT KIT
TWD 5-280X	1710 U-JOINT KIT
TWD 5-281X	1810 U-JOINT KIT
TWD 5-308X	1880 U-JOINT KIT
TWD 5-3147X	3R U-JOINT ASSEMBLY
TWD 5-324X	1810/92N U-JOINT KIT
TWD 5-326X	1880/9C U-JOINT KIT
TWD 5-407X	1760 U-JOINT KIT
TWD 5-785X	1310 U-JOINT KIT
TWD 5-790X	1330 U-JOINT KIT (SPL25)
TWD 5-795X	3R U-JOINT ASSEMBLY
TWD 5-799X	1350 U-JOINT KIT
TWD 5-801X	1410 U-JOINT KIT

⚠ WARNING: California Proposition 65 - Cancer and Reproductive Harm - www.P65Warnings.ca.gov.

G
DRIVE SYSTEMS



SVL (VALUE LINE BY DANA) U-JOINT KITS

AUTOMOTIVE



PART NO.	DESCRIPTION	SERIES
TWD 15-134X	LD SVL U-JOINT KIT	1310 - 1330
TWD 15-153X	LD SVL U-JOINT KIT	1310
TWD 15-155X	LD SVL U-JOINT KIT	1550
TWD 15-160X	LD SVL U-JOINT KIT	1410
TWD 15-170X	LD SVL U-JOINT KIT	1000
TWD 15-178X	LD SVL U-JOINT KIT	1350
TWD 15-188X	LD SVL U-JOINT KIT	1480
TWD 15-213X	LD SVL U-JOINT KIT	1330
TWD 15-3147X	LD SVL U-JOINT KIT	S44

COMMERCIAL VEHICLE



PART NO.	DESCRIPTION	SERIES
TWD 15-677X	HD SVL U-JOINT KIT	1810 (HALF ROUND)

OFF HIGHWAY



PART NO.	DESCRIPTION	SERIES
TWD 15-5111X	SVL U-JOINT KIT	5C (HWD)
TWD 15-6111X	SVL U-JOINT KIT	6C (HWD)
TWD 15-7111X	SVL U-JOINT KIT	7C (HWD)
TWD 15-8111X	SVL U-JOINT KIT	8C (HWD)
TWD 15-85111X	SVL U-JOINT KIT	8.5C (HWD)
TWD 15-9111X	SVL U-JOINT KIT	9C (HWD)

⚠ WARNING: California Proposition 65 - Cancer and Reproductive Harm - www.P65Warnings.ca.gov.



SVL (VALUE LINE BY DANA) U-JOINT KITS (continued)

CENTER BEARING

	PART NO.	DESCRIPTION	SERIES
	TWD 210084-2XV	HD SVL CENTER BEARING	1410 - 1650
	TWD 210088-1XV	LD SVL CENTER BEARING	1280 - 1410
	TWD 210207-1XV	LD SVL CENTER BEARING	1410 - 1650
	TWD 210391-1XV	LD SVL CENTER BEARING	1310 - 1550
	TWD 210866-1XV	LD SVL CENTER BEARING	1310 - 1550
	TWD 210875-1XV	HD SVL CENTER BEARING	1760 - 1810
	TWD 210433-1XV	LD SVL CENTER BEARING	1310 - 1550

⚠ WARNING: California Proposition 65 - Cancer and Reproductive Harm - www.P65Warnings.ca.gov.

SPL (SPICER LIFE SERIES) U-JOINT KITS

	PART NO.	DESCRIPTION
	TWD SPL100-1X	SPL100 U-JOINT KIT
	TWD SPL140X	SPL140-U-JOINT KIT
	TWD SPL250-3X	SPL250-H/R U-JOINT KIT
	TWD SPL36-1X	1410 U-JOINT KIT
	TWD SPL55-3X	SPL55-U-JOINT KIT
	TWD SPL70X	SPL70-U-JOINT KIT

⚠ WARNING: California Proposition 65 - Cancer and Reproductive Harm - www.P65Warnings.ca.gov.

HANGER BEARINGS

	PART NO.	DESCRIPTION
	TWD 210088-1X	1310/1410 HANGER BEARING
	TWD 210084-2X	1550/1610 HANGER BEARING
	TWD 210121-1X	SPL90/1710 HANGER BEARING
	TWD 210866-1X	1310/1480 HANGER BEARING

⚠ WARNING: California Proposition 65 - Cancer and Reproductive Harm - www.P65Warnings.ca.gov.

G
DRIVE SYSTEMS



TUBE YOKES

	PART NO.	DESCRIPTION
	TWD 628347	1710 TUBE YOKE
	TWD 628467	1710 TUBE YOKE
	TWD 1702817	SPL170 TUBE YOKE
	TWD 1702827	SPL170 TUBE YOKE
	TWD 2502817	SPL250 TUBE YOKE
	TWD 6528117	1810 TUBE YOKE
	TWD 6528127	1810 TUBE YOKE
	TWD 632817	1760 TUBE YOKE

⚠ WARNING: California Proposition 65 - Cancer and Reproductive Harm - www.P65Warnings.ca.gov.

SLIP YOKES

	PART NO.	DESCRIPTION
	TWD 632651KX	1710 SLIP YOKE ASSEMBLY
	TWD 632671KX	1710 SLIP YOKE ASSEMBLY
	TWD 633441KX	1710 SLIP YOKE ASSEMBLY
	TWD 63321KX	1760 SLIP YOKE ASSEMBLY
	TWD 63341KX	1760 SLIP YOKE ASSEMBLY
	TWD 6531351KX	1810 SLIP YOKE ASSEMBLY
	TWD 6531371KX	1810 SLIP YOKE ASSEMBLY
	TWD 6531451KX	1810 SLIP YOKE ASSEMBLY

⚠ WARNING: California Proposition 65 - Cancer and Reproductive Harm - www.P65Warnings.ca.gov.

END YOKES

	PART NO.	DESCRIPTION
	TWD 646371	1710 B/P END YOKE
	TWD 646871X	1710 B/P END YOKE ASSEMBLY
	TWD 647181X	1710 B/P END YOKE ASSEMBLY
	TWD 6477711X	1710 B/S END YOKE ASSEMBLY
	TWD 647771X	1710 B/P END YOKE ASSEMBLY
	TWD 6542531X	1810 B/P END YOKE ASSEMBLY
	TWD 6542711X	1810 B/P END YOKE ASSEMBLY
	TWD 6543381X	1810 B/P END YOKE ASSEMBLY
	TWD 6543561X	1810 B/P END YOKE ASSEMBLY
	TWD 6543731X	1810 B/P END YOKE ASSEMBLY
	TWD 65445711X	1810 B/S END YOKE ASSEMBLY
	TWD 6544631	1810 B/P END YOKE

⚠ WARNING: California Proposition 65 - Cancer and Reproductive Harm - www.P65Warnings.ca.gov.

END YOKE COUPLINGS

	PART NO.	DESCRIPTION
	TWD 6471411	1710 B/S COUPLING END YOKE

⚠ WARNING: California Proposition 65 - Cancer and Reproductive Harm - www.P65Warnings.ca.gov.



YOKE SHAFTS

	PART NO.	DESCRIPTION
	TWD 68213412	1710 YOKE SHAFT

⚠ WARNING: California Proposition 65 - Cancer and Reproductive Harm - www.P65Warnings.ca.gov.

SLIP STUB SHAFTS

	PART NO.	DESCRIPTION
	TWD 640521	1710/1760 SLIP STUB SHAFT
	TWD 640541	1610/1760 SLIP STUB SHAFT
	TWD 6540201	1810 SLIP STUB SHAFT

⚠ WARNING: California Proposition 65 - Cancer and Reproductive Harm - www.P65Warnings.ca.gov.

MIDSHIP SHAFTS

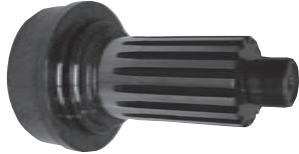
	PART NO.	DESCRIPTION
	TWD 653311	1710/1760 MIDSHIP SHAFT
	TWD 655391	1710/1810 MIDSHIP SHAFT

⚠ WARNING: California Proposition 65 - Cancer and Reproductive Harm - www.P65Warnings.ca.gov.

UNWELDED SHAFTS

	PART NO.	DESCRIPTION
	TWD 95534724	1310 UNWELDED SHAFT ASSEMBLY
	TWD 102705729	1000 UNWELDED DRIVESHAFT

⚠ WARNING: California Proposition 65 - Cancer and Reproductive Harm - www.P65Warnings.ca.gov.

G
DRIVE SYSTEMS





H





TRUCK AND TRAILER ACCESSORIES

CARGO CONTROL.....	214-218
MUDFLAPS.....	218-220
MUDFLAP HANGERS.....	220-221
SEATS & ACCESSORIES.....	222-223
GAUGES & ACCESSORIES.....	224-225
HORNS & ACCESSORIES.....	226-227
TRUCK AND TRAILER DOORS & COMPONENTS.....	228
RUBBER BUMPERS.....	229
LOAD SIGNS & SAFETY PRODUCTS.....	230-233



FLATBED PRODUCTS

WINCH STRAPS

	PART NO.	LENGTH (FT)	WEBBING SIZE	WITH	WORKING LOAD LIMIT
	TWD 416601030	30	3"	1021 FLAT HOOK, ABRASION CLIP & 3084FK WEBBING	5,400 LBS / 2,450 KG
	TWD 437951130	30	4"	1026 DELTA RING & 4080FK WEBBING	5,400 LBS / 2,450 KG
	TWD 437951030	30	4"	1021 FLAT HOOK, ABRASION CLIP & 4080FK WEBBING	5,400 LBS / 2,450 KG
	TWD 416601430	30	3"	3705-3 CHAIN ANCHOR & 3084FK WEBBING	5,400 LBS / 2,450 KG
	TWD 437951530	30	4"	3705-3 CHAIN ANCHOR & 4080FK WEBBING	5,400 LBS / 2,450 KG

WINCH BARS

	PART NO.	DESCRIPTION	FINISH
	TWD 4231310	STANDARD BAR	PAINTED
	TWD 4231317	STANDARD BAR	CHROME PLATED

RATCHET STRAPS

3" RATCHET STRAPS

	PART NO.	LENGTH (FT)	WITH	WORKING LOAD LIMIT
	TWD 4898725	30	CHAIN ANCHORS	5,400 LBS / 2,450 KG

⚠ WARNING: California Proposition 65 - Cancer and Reproductive Harm - www.P65Warnings.ca.gov.

H





TRUCK & TRAILER ACCESSORIES



FLATBED PRODUCTS (continued)

RATCHET STRAPS

2" RATCHET STRAPS

	PART NO.	LENGTH (FT)	WITH	WORKING LOAD LIMIT
	TWD 4598242	27	WIRE HOOKS	3,335 LBS / 1,513 KG
	TWD 4598243	30	WIRE HOOKS	3,335 LBS / 1,513 KG
	TWD 4797011	30	FLAT HOOKS	3,335 LBS / 1,513 KG
	TWD 4797111	30	FLAT HOOKS	3,335 LBS / 1,513 KG
	TWD 4598234	30	CHAIN ANCHORS	3,335 LBS / 1,513 KG

FOUR-PACK RATCHET STRAP SET

	PART NO.	DESCRIPTION
	TWD 4936810	1" LIGHT DUTY STRAPS, 12' LONG, 4-PACK

GRADE 70 TRANSPORTATION CHAINS

	PART NO.	SIZE	LENGTH (FT)	WORKING LOAD LIMIT
	TWD 4588010	5/16	550	4,700 LBS / 2,135 KG
	TWD 4588011	3/8	400	6,600 LBS / 3,000 KG

⚠ WARNING: California Proposition 65 - Cancer and Reproductive Harm - www.P65Warnings.ca.gov.



TRUCK & TRAILER ACCESSORIES



FLATBED PRODUCTS (continued)

LEVER CHAIN BINDER

	PART NO.	CHAIN	WORKING LOAD LIMIT
	TWD 4594310	5/16" - 3/8"	5,400 LBS / 2,450 KG

RATCHET CHAIN BINDER

	PART NO.	CHAIN	WORKING LOAD LIMIT
	TWD 4594320	5/16" - 3/8"	5,400 LBS / 2,450 KG

CLEVIS GRAB HOOK

	PART NO.	SIZE	WORKING LOAD LIMIT	WEIGHT	MATERIAL
	TWD 10038GH	3/8"	6,600 LBS / 3,000 KG	1.10 LB / 0.50 KG	ALLOY - GRADE 70

CORNER PROTECTORS

	PART NO.	MATERIAL	FOR USE WITH
	TWD 4937710	STEEL	1-3/4" - 2" WEB, CABLE, CHAIN
	TWD 4398610	PLASTIC	2" - 4" WEB
	TWD 4958410	PLASTIC	2" - 4" WEB, CHAIN

⚠ WARNING: California Proposition 65 - Cancer and Reproductive Harm - www.P65Warnings.ca.gov.



I

TRUCK & TRAILER ACCESSORIES



INTERIOR VAN PRODUCTS

2" LOGISTIC STRAPS W/ 811 RATCHET BUCKLE

	PART NO.	LENGTH (FT)	END HARDWARE	WORKING LOAD LIMIT
	TWD 4867213	20	SERIES E OR A FE8306-1 SPRING FITTING	1,000 LBS / 455 KG
	TWD 4867215	20	1005 NARROW HOOK	500 LBS / 230 KG



2" LOGISTIC STRAPS W/ 910 CAM BUCKLE

	PART NO.	LENGTH (FT)	END HARDWARE	WORKING LOAD LIMIT
	TWD 4060217	12	SERIES E OR A FE8306-1 SPRING FITTING	835 LBS / 380 KG
	TWD 4060218	16		

SERIES E TRACK - HORIZONTAL

	PART NO.	MATERIAL	MIN YIELD	FINISH	WEIGHT	LENGTH
	TWD 4811721120	HIGH STRENGTH STEEL (12 GA)	50,000 PSI	GALVANIZED	16.2 LBS / 7.26 KG	10 FT / 3 M

DECKING / SHORING BEAMS

	PART NO.	DESCRIPTION	ADJUSTS FROM	WEIGHT
	TWD 4363851	SERIES A OR E ALUMINUM BEAM	92.9" TO 102.3" FOR 96" AND 102" TRAILERS	18.8 LBS / 8.5 KG
	TWD 4903951	HD SERIES A OR E ALUMINUM BEAM	92.9" TO 102.3" FOR 96" AND 102" TRAILERS	22.3 LBS / 10.1 KG

SQUARE ONE-PIECE GALVANIZED JACK BAR

	PART NO.	ADJUSTS FROM	WEIGHT	COMMENTS
	TWD 4920526	86" TO 114"	17.2 LBS / 7.8 KG	EXTRA LONG RACK

⚠ WARNING: California Proposition 65 - Cancer and Reproductive Harm - www.PG5Warnings.ca.gov.



TRUCK & TRAILER ACCESSORIES



INTERIOR VAN PRODUCTS (continued)

SAF-T-LOK BARS

	PART NO.	MATERIAL	ADJUSTS FROM	WEIGHT
	TWD 4840710	STEEL	90" TO 105"	11.4 LBS / 5.18 KG
	TWD 4378215	ALUMINUM	90" TO 105"	8.5 LBS / 3.9 KG

ROPE TIE-OFF

	PART NO.	SERIES	WORKING LOAD LIMIT	FITTING	LENGTH
	TWD 4038611	A OR E	1,000 LBS / 455 KG	FE8306-1	6"

⚠ WARNING: California Proposition 65 - Cancer and Reproductive Harm - www.P65Warnings.ca.gov.



MUD FLAPS

WHEEL CHOCK

	PART NO.	SIZE
	TWD 7303997	5-5/8" (W) X 9-1/2" (L) X 7-3/4" (H)

SOLID PANEL MUD FLAPS - NYRACORD® RUBBER

	PART NO.	SIZE
	TWD 8235076	1/4" X 24" X 36"
	TWD 8235075	3/8" X 24" X 30"
	TWD 8231275	1/4" X 24" X 24"

⚠ WARNING: California Proposition 65 - Cancer and Reproductive Harm - www.P65Warnings.ca.gov.



MUD FLAPS (continued)

STANDARD MUD FLAPS WITH NAPA LOGO - NYRACORD® RUBBER

	PART NO.	SIZE
	TWD 8172005	1/4" X 24" X 30"
	TWD 8172010	1/4" X 24" X 36"

BLACK RUBBER MUD FLAPS - NYRACORD® RUBBER

	PART NO.	SIZE
	TWD 8231281	1/4" X 24" X 30"
	TWD 8231280	1/4" X 24" X 24"
	TWD 8231282	1/4" X 24" X 36"

HEAVY-DUTY MUD FLAPS WITH NAPA LOGO - NYRACORD® RUBBER

	PART NO.	SIZE
	TWD 8232018	1/4" X 24" X 24"

EXTRA HEAVY-DUTY MUD FLAPS

	PART NO.	SIZE
	TWD 8235092	3/8" X 24" X 30"
	TWD 8235093	3/8" X 24" X 36"

⚠ WARNING: California Proposition 65 - Cancer and Reproductive Harm - www.P65Warnings.ca.gov.



TRUCK & TRAILER ACCESSORIES

MUD FLAPS & MUD FLAP HANGERS



MUD FLAPS (continued)

HEAVY-DUTY SPLASH GUARD

	PART NO.	SIZE
	TWD 8217048	1/4" X 12" X 18"
	TWD 8215203	1/4" X 19" X 24"
	TWD 8215239	1/4" X 18" X 24"

⚠ WARNING: California Proposition 65 - Cancer and Reproductive Harm - www.P65Warnings.ca.gov.



MUD FLAP HANGERS

These .640 square spring steel hangers, standard equipment on many new trucks, are the workhorse of the industry. Betts hangers are shot peened and painted to ensure long life. Hangers and mounting brackets are interchangeable to suit your application.



	PART NO.	DESCRIPTION
	TWD BETA25RL	<ul style="list-style-type: none"> • Straight Bar • Single Hanger • Heavy Duty .640" Square Spring Steel • Nominal Length: 29.750" • Unhanded-Fits Left and Right

⚠ WARNING: California Proposition 65 - Cancer and Reproductive Harm - www.P65Warnings.ca.gov.



MUD FLAP HANGERS (continued)

	PART NO.	DESCRIPTION
	TWD BETB25	<ul style="list-style-type: none"> • Kit/Upgrade • Boxed Kit w/ All Hardware • OEM, HD .640" Square Spring Steel • Nominal Length: 29.750" • Unhanded-Fits Left and Right
	TWD BETB23	<ul style="list-style-type: none"> • Kit/Upgrade • Boxed Kit w/ All Hardware • OEM, HD .640" Square Spring Steel • Nominal Length: 29.750" • Unhanded-Fits Left and Right
	TWD BETB82	<ul style="list-style-type: none"> • Kit/Upgrade • Boxed Kit w/ All Hardware • Extra HD .750" Square Spring Steel • Nominal Length: 29.750" • Unhanded-Fits Left and Right
	TWD BETB35	<ul style="list-style-type: none"> • Kit/Upgrade • Boxed Kit w/ All Hardware • HD .640" Square Spring Steel • Nominal Length: 27.500" • Both Left and Right Hand
	TWD B673025WTBK	<ul style="list-style-type: none"> • Angled • Boxed Kit w/ All Hardware • Mount. Stud Centers - 1.125" • Nominal Length: 30.250" • Both Left and Right Hand
	TWD BETRT25	<ul style="list-style-type: none"> • Kit/Blister Pack • Inc. (2) RT25RL Conspicuity Strips • Lightweight Aluminum Construction • Use w/ Straight Bar or Spring-Loaded Hangers • Unhanded-Fits Left and Right



TRUCK & TRAILER ACCESSORIES

⚠ WARNING: California Proposition 65 - Cancer and Reproductive Harm - www.P65Warnings.ca.gov.



BOSTROM SEATS



- Air Suspension Seat
- 3.8" Ride Zone
- Mid or High Back
- 9.5" Fore & Aft Adjustment
- Mechanical Lumbar Support

PART NO.	DESCRIPTION
TWD 2343071-550	HIGH BACK, BLACK CLOTH
TWD 2343070-550	MID BACK, BLACK CLOTH



- Air Suspension Seat
- 6" Ride Zone
- 9.5" Fore & Aft Adjustment

PART NO.	DESCRIPTION
TWD 2339131-550	HIGH BACK; BLACK CLOTH
TWD 2339130-550	MID BACK; BLACK CLOTH

WIDE RIDE



- 21" Wide and 19" Long Seat Cushion for Added Comfort
- 6" Ride Zone
- 9.5" Fore & Aft Adjustment
- Heavy Duty Dual Shocks for Greater Stability
- Suspension Cover
- Longer Adjustment Levers for Easier Operation
- Two-Chamber Air Lumbar Support
- Front Seat Tilt Adjustment

PART NO.	DESCRIPTION
TWD 2345039-900	HIGH BACK, DUAL ARMREST; BLACK ULTRA-LEATHER HPA
TWD 2345038-900	MID BACK, DUAL ARMREST; BLACK ULTRA-LEATHER HPA

⚠ WARNING: California Proposition 65 - Cancer and Reproductive Harm - www.P65Warnings.ca.gov.

H

TRUCK & TRAILER ACCESSORIES



BOSTROM SEATS (continued)

SIGNATURE SERIES PATRIOT



- 5" Ride Zone
- 21" Wide and 18" Long Seat Cushion
- 9.5" Fore and Aft Adjustment
- Flex Support System
- Increased and Contoured Seat and Back Foam for Better Ergonomics
- Isolating Suspension
- Front Seat Tilt Adjustment
- Single Heavy Duty Damper
- Two Position Front Cushion Adjustment

PART NO.	DESCRIPTION
TWD 2356001-552	MECHANICAL LUMBAR AND DUAL ARMESTS, GREY CLOTH

⚠ WARNING: California Proposition 65 - Cancer and Reproductive Harm - www.P65Warnings.ca.gov.

BOSTROM SEATING ACCESSORIES

DAMPER KITS

PART NO.	DESCRIPTION
TWD 6222082-001	HEAVY DUTY DAMPER KIT (HIGH PROFILE)
TWD 6222079-001	HEAVY DUTY DAMPER KIT (LOW PROFILE)

MISCELLANEOUS KITS

PART NO.	DESCRIPTION
TWD 6222035-001	SC COMPRESSOR KIT (T910/T905)
TWD 6222051-001	DAMPER ASSEMBLY KIT

⚠ WARNING: California Proposition 65 - Cancer and Reproductive Harm - www.P65Warnings.ca.gov.



TRUCK & TRAILER ACCESSORIES



FUEL SENDERS



PART NO.	OEM	MAKE	MODEL	YEARS
NHD 223-9000	2585993C91, 3591593C1	INTERNATIONAL	3200 BUS CHASSIS, 4100 4200 4300 4400 MEDIUM DUTY, 5500I 5600I SEVERE SERVICE, 7300 7400 7500 7600 SEVERE SERVICE, 8500 HEAVY TRACTORS	2011-01
NHD 223-9001	3596382C92, 3596382C91	INTERNATIONAL	9200 9400 PREMIUM CONVENTIONAL, 9800 PREMIUM CABOVER, 9900 PREMIUM CONVENTIONAL WITH 26" TANK	2011-96
NHD 223-9002	476846C2, 476846C1	INTERNATIONAL	1400 1600 STRIPPED CHASSIS, 1652 UPS STRIPPED CHASSIS, 2500 2600 MEDIUM DUTY, 3000 3400 3600 3700 3800 3900 BUS CHASSIS, 4500 4600 4700 4800 4900 MEDIUM DUTY, 5000 SEVERE SERVICE, 7100 MEDIUM TRUCK, 8100 HEAVY TRACTORS 15" TANK	2011-97
NHD 223-9003	497840C96, 497840C95, 497840C94	INTERNATIONAL	13" DEEP TANK	1991-85
NHD 223-9004	A22-42390-005	FREIGHTLINER	CLASSIC, FL, FLD SERIES	1999-94
NHD 223-9005	K21-6001-661	PETERBILT	26" DIAMETER TANK	2011-87
NHD 223-9006	K21-6001-585	PETERBILT	23" DIAMETER TANK	2011-87
NHD 223-9007	391PLP	PETERBILT	UNIVERSAL	2011-87
NHD 223-9008	Q21-1024-622	KENWORTH	24.5" DIAMETER FUEL TANK WITH HARNESS	2011-87
NHD 223-9009	Q21-1024-559	KENWORTH	22.5" DIAMETER FUEL TANK	2011-87
NHD 223-9010	Q21-1043-622	KENWORTH	24.5" DIAMETER FUEL TANK WITHOUT HARNESS	2011-87
NHD 223-9011	20506805, 20566665	MACK	GU, CTP, CT	2011-07
NHD 223-9012	25172994	MACK	CV	2003
NHD 223-9013	16MB48DP13	MACK	DM, MR (W/ RECTANGULAR TANK)	2003-91
NHD 223-9014	25172995	MACK	CV	2004-02
NHD 223-9015	16MB48DP29	MACK	CH, CX	2010-08
NHD 223-9016	25101400	MACK	CH, CX	2003-95
NHD 223-9017	25195325	MACK	RD	2009-89
NHD 223-9018	8609-NC2759	MACK	UNIVERSAL	2011-95
NHD 223-9019	3092995, 3092993, 85134274	VOLVO	WA, WG, WX	2009-90

⚠ WARNING: This product can expose you to chemicals including Chromium, which are known to the State of California to cause cancer and birth defects or other reproductive harm. For more information go to www.P65Warnings.ca.gov.



SPEED SENSORS



PART NO.	OEM	MAKE	MODEL	YEARS
NHD 656-9000	2503117C1	INTERNATIONAL	9600, 9700	1998-90
NHD 656-9001	3528003C1	INTERNATIONAL	1000, 4000, 5000, 7000, 8000, AND 9000 SERIES	2007-97
NHD 656-9002	SAA85920008	FREIGHTLINER	SCREW IN SPEED SENSOR FOR FREIGHTLINER AND STERLING USING A MERRITOR TRANS W/ INTERNAL TONE RING	2011-89
NHD 656-9008	25166488	MACK	SCREW IN STYLE, WITH EATON TRANSMISSION, 1 CONNECTOR WITH 2 TERMINALS	2010-89
NHD 656-9011	8029939	VOLVO	ALL VOLVO MODELS	2011-89
NHD 656-9013	20706327	MACK	ENGINE SPEED SENSOR FOR ALL MACK USING A PUSH IN SENSOR IN TIMING COVER OR BELL HOUSING	2011-97

⚠ WARNING: This product can expose you to chemicals including Acrylonitrile, which are known to the State of California to cause cancer and birth defects or other reproductive harm. For more information go to www.P65Warnings.ca.gov.

TACHOMETER SENSOR



PART NO.	OEM	MAKE	MODEL	YEARS
NHD 656-9006	64MT2105M	MACK	RD, CH	1995-87
NHD 656-9007	64MT435	MACK	CH, MR	2001-90
NHD 656-9009	64MT440M	MACK	RD, CH	2010-89
NHD 656-9012	8078108	VOLVO	ALL VOLVO MODELS	2011-89

⚠ WARNING: This product can expose you to chemicals including Acrylonitrile, which are known to the State of California to cause cancer and birth defects or other reproductive harm. For more information go to www.P65Warnings.ca.gov.



TRUCK & TRAILER ACCESSORIES



AIR HORNS

RECTANGULAR SINGLE HORN ASSEMBLIES

	PART NO.	OVERALL LENGTH	FINISH
	TWD H00977	29"	CHROME
	TWD H00978	26"	
	TWD H00984B	20"	

RECTANGULAR SINGLE HORN ASSEMBLIES

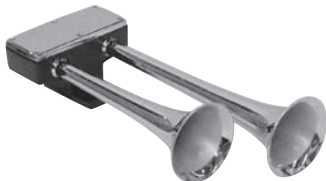
	PART NO.	OVERALL LENGTH	FINISH	PTC FITTING SIZE	HORN
	TWD H00640R	14-15/16"	BLACK	1/4"	METAL

BULLY DUAL AIR HORN KIT



	PART NO.	DESCRIPTION
	TWD H00900CA	<ul style="list-style-type: none"> • BLACK BODY, CHROME PROJECTORS • FOR VEHICLES WITH AIR SOURCE • DIMENSIONS: 15-1/2" L. X 6-7/8" W. X 4-1/2" H. • KIT INCLUDES EVERYTHING NEEDED TO MOUNT THE HORNS: COMPRESSORS, HOSES, AND FITTINGS W/ COMPLETE INSTRUCTIONS

⚠ WARNING: California Proposition 65 - Cancer and Reproductive Harm - www.P65Warnings.ca.gov.

H

TRUCK & TRAILER ACCESSORIES

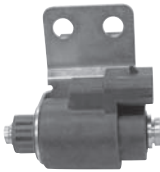

AIR HORN SOLENOID VALVES		
	PART NO.	DESCRIPTION
	TWD H00550B	<ul style="list-style-type: none"> • 12 VOLT • TANK MOUNTED SOLENOID AND MOUNTING HARDWARE
	TWD H00550C	<ul style="list-style-type: none"> • 12 VOLT • HORN MOUNTED SOLENOID AND MOUNTING HARDWARE
	TWD H00570CF	<ul style="list-style-type: none"> • 12 VOLT • REMOTE MOUNT SOLENOID WITH PTC FITTINGS

 WARNING: California Proposition 65 - Cancer and Reproductive Harm - www.P65Warnings.ca.gov.

AIR HORN ACCESSORIES		
	PART NO.	DESCRIPTION
	TWD H11477S	MOUNTING ELBOW AND TENSION WASHER KIT
	TWD H13723S	CHROME AIR HORN PROJECTOR SUPPORT W/MOUNTING PADS
	TWD H13940S	PRESSURE SWITCH (110-135 PSI)

 WARNING: California Proposition 65 - Cancer and Reproductive Harm - www.P65Warnings.ca.gov.



TRUCK & TRAILER ACCESSORIES



Quality since 1946

HOOD CATCHES

	PART NO.	DESCRIPTION
	TWD WJ195	4" "EASYGRIP" RUBBER HOOD CATCH, WITH BRACKET
	TWD WJ201A	4-7/8" RUBBER HOOD CATCH, WITH "A" BRACKET
	TWD WJ202	2-1/2" MINIATURE RUBBER HOOD CATCH, WITH BRACKET
	TWD WJ206	6" HEAVY-DUTY RUBBER HOOD CATCH, INCLUDES BRACKETS AND PIN
	TWD WJ208	7-7/8" HEAVY-DUTY RUBBER HOOD CATCH, INCLUDES BRACKETS AND PIN

⚠ WARNING: California Proposition 65 - Cancer and Reproductive Harm - www.P65Warnings.ca.gov.

I

TRUCK & TRAILER ACCESSORIES



RUBBER BUMPERS		
	PART NO.	DESCRIPTION
	TWD HRB2155	5" L. X 3-1/4" W. X 3-1/2" H. 1/2" Ø, C.C. 2-1/2"
	TWD HRB2156	8" L. X 5-1/2" W. X 3-1/2" H. 1/2" Ø C.C. 5-7/16" - 3-1/8"
	TWD HRB2157	6" L. X 4" W. X 3-1/4" H. 7/16" Ø C.C. 2-1/2"
	TWD HRB2158	8" L. X 2-1/2" W. X 2" H. 3/8" Ø C.C. 4-1/2"
	TWD HRB2159	16" L. X 2-1/2" W. X 2" H. 3/8" Ø C.C. 6-3/8" - 6-3/8"
	TWD HRB2173	6" L. X 3" W. X 3" H. 1/2" Ø C.C. 2-1/2"

TRUCK & TRAILER ACCESSORIES

⚠ WARNING: California Proposition 65 - Cancer and Reproductive Harm - www.P65Warnings.ca.gov.



LOAD SIGNS

REFLECTIVE DIMENSIONAL LOAD SIGNS

	PART NO.	DESCRIPTION
	TWD BP650-A	1' X 8', ALUMINUM

WIDE LOAD/OVERSIZE LOAD SIGN

	PART NO.	DESCRIPTION
	TWD BP670-1	1' X 8', VINYL

⚠ WARNING: California Proposition 65 - Cancer and Reproductive Harm - www.P65Warnings.ca.gov.

H

TRUCK & TRAILER ACCESSORIES



SAFETY DECALS

	PART NO.	DESCRIPTION		PART NO.	DESCRIPTION
	TWD D709	Diesel W/Oval		TWD D740	First Aid Inside Decal
	TWD D711	Gas W/Oval Decal		TWD D704	No Smoking Decal
	TWD FX12	Fire Extinguisher Inside		TWD D710	Hyd-Oil W/Oval Decal
	TWD D607	Diesel Fuel Only		TWD FX11	Fire Extinguisher Inside
	TWD CV102	12X72 OSL/WL Banner			

⚠ WARNING: California Proposition 65 - Cancer and Reproductive Harm - www.P65Warnings.ca.gov.



SAFETY FLAGS		
	PART NO.	DESCRIPTION
	TWD MF101	Magnetic Flag Holder - 80 lbs.
	TWD FW400C	18"x18" Flo-Orange Mesh Flag with Wire Loop
	TWD FW300C	18"x18" Red Jersey Flag with Wire Loop
	TWD FS400C	Orange Mesh Flag with Wooden Staff - 18"x18"
	TWD FW200C	18" Red Cotton Flag with Wire Loop
	TWD FS300C	Red Jersey Flag with Wooden Staff - 18"x18"





⚠ WARNING: California Proposition 65 - Cancer and Reproductive Harm - www.P65Warnings.ca.gov.



TRUCK & TRAILER ACCESSORIES



SAFETY FLAGS (continued)

	PART NO.	DESCRIPTION
	TWD FW200A	12" Red Cotton Flag with Wire Loop
	TWD FW300CR	18"x18" Red Jersey Flag with Wire Loop
	TWD FW400A	12" Flo-Orange Mesh Flag with Wire Loop
	TWD FW300A	12" Red Jersey Flag with Wire Loop
	TWD FS400A	12"x12" Orange Mesh Flag with Wooden Staff

⚠ WARNING: California Proposition 65 - Cancer and Reproductive Harm - www.P65Warnings.ca.gov.

I

TRUCK & TRAILER ACCESSORIES



SAFETY FLAGS (continued)

	PART NO.	DESCRIPTION
	TWD BP100	<ul style="list-style-type: none"> • 15" X 16" POLYESTER SAFETY FLAG • FLOURESCENT ORANGE
	TWD BP300	<ul style="list-style-type: none"> • 16" X 16" MESH SAFETY FLAG • ORANGE
	TWD BP304	<ul style="list-style-type: none"> • 18" X 18" MESH SAFETY FLAG WITH 36" DOWEL • ORANGE

⚠ WARNING: California Proposition 65 - Cancer and Reproductive Harm - www.P65Warnings.ca.gov.

SAFETY VEST

	PART NO.	DESCRIPTION
	TWD BP400	<ul style="list-style-type: none"> • RETRO REFLECTIVE TRAFFIC SAFETY VEST • ONE SIZE FITS ALL • REFLECTIVE ORANGE

⚠ WARNING: California Proposition 65 - Cancer and Reproductive Harm - www.P65Warnings.ca.gov.



TRUCK & TRAILER ACCESSORIES



TRIANGLE WARNING KIT

	PART NO.	DESCRIPTION
	GRO 71422	<ul style="list-style-type: none"> • KIT OF THREE TRIANGLE DEVICES IN CARRYING CASE • 16-3/4" HEIGHT, REFLECTIVE UP TO 1/2 MILE

⚠ WARNING: California Proposition 65 - Cancer and Reproductive Harm - www.P65Warnings.ca.gov.









I

LIGHTS AND ELECTRICAL ACCESSORIES

SEALED BEAM LAMPS	236
HEADLIGHTS	237-239
CLEARANCE - MARKER LAMPS	240-250
STOP-TURN TAIL LAMPS	251-256
MISCELLANEOUS LIGHTS & HARNESS	257-261
PIGTAILS	262-263
WORK LAMPS	264-267
REFLECTORS	267-269
STROBES & EMERGENCY LIGHTING	270-273
POWER CORDS & AIR HOSES	273
ELECTRICAL CABLE ASSEMBLIES	274-276
PLUGS, SOCKETS & ACCESSORIES	277-282
CIRCUIT PROTECTION & WIRING	283-284
SWITCHES & SOLENOIDS	285-292
WARNING DEVICES & PILOT LIGHTS	293



LED SEALED BEAM REPLACEMENT LAMPS

	PART NO.	DESCRIPTION
	LIT 27270C	<ul style="list-style-type: none"> • 7" ROUND LED HEADLAMP • MULTI-VOLT, COMPLEX REFLECTOR OPTICS
	LIT 27450C	<ul style="list-style-type: none"> • 5" X 7" RECTANGULAR LED HEADLAMP • MULTI-VOLT, COMPLEX REFLECTOR OPTICS
	LIT 27640C	RECTANGULAR LED LAMP FRONT LOW BEAM 4" X 6"
	LIT 27645C	RECTANGULAR LED LAMP FRONT HIGH BEAM 4" X 6"
	LIT 80220	<ul style="list-style-type: none"> • LED PAR 36 WORK LAMP, 4.46" ROUND • FITS INTO ANY STANDARD PAR 36 BULB APPLICATION

⚠ WARNING: California Proposition 65 - Cancer and Reproductive Harm - www.P65Warnings.ca.gov.



HEADLIGHT ASSEMBLIES



PART NO.	OEM	ORIENTATION	MAKE	MODEL	YEARS
NHD 800-9000	3605817C92	RIGHT	INTERNATIONAL	WORKSTAR	2011-09
NHD 800-9001	3605816C92	LEFT	INTERNATIONAL	WORKSTAR	2011-09
NHD 800-9002	3502929C94	RIGHT	INTERNATIONAL	5900, 9200	2008-94
NHD 800-9003	3502928C94	LEFT	INTERNATIONAL	5900, 9200	2008-94
NHD 800-9004	3574388C91, 3574388C92, 3574388C93	RIGHT	INTERNATIONAL	4000, 7000, 8500, AND RXT	2011-08
NHD 800-9005	3574387C91, 3574387C92, 3574387C93	LEFT	INTERNATIONAL	4000, 7000, 8500, AND RXT	2011-08
NHD 800-5107	3596016C93	RIGHT	INTERNATIONAL	PROSTAR	2015-09
NHD 800-5108	3596015C93	LEFT	INTERNATIONAL	PROSTAR	2015-09
NHD 800-5109	3565430C93, 3565430C92, 3565430C91	RIGHT	INTERNATIONAL	3300, 4400, 8600, BE200, CE200, 300FBC COM BUS	2011-08
NHD 800-5110	3565429C93, 3565429C92, 3565429C91	LEFT	INTERNATIONAL	3300, 4400, 8600, BE200, CE200, 300FBC COM BUS	2011-08
NHD 800-9006	A06-75737-005	RIGHT	FREIGHTLINER	COLUMBIA	2011-05
NHD 800-9007	A06-75737-004	LEFT	FREIGHTLINER	COLUMBIA	2011-05
NHD 800-5203	A06-75732-005	RIGHT	FREIGHTLINER	M2	2011-02
NHD 800-5204	A06-75732-004	LEFT	FREIGHTLINER	M2	2011-02
NHD 800-5205	A06-51907-007, A06-51907-003	RIGHT	FREIGHTLINER	CASCADIA	2013-08
NHD 800-5206	A06-51907-006, A06-51907-002	LEFT	FREIGHTLINER	CASCADIA	2013-08
NHD 800-5403	16-09190-R	RIGHT	PETERBILT	386, 387	2014-08
NHD 800-5404	16-09190-L	LEFT	PETERBILT	386, 387	2014-08
NHD 800-5501	25163253, 2M0520M	RIGHT	MACK	CL713	2003-93
NHD 800-5502	25154252, 2M0521M	LEFT	MACK	CL713	2003-93
NHD 800-5503	25166301, 2M0525AM	RIGHT	MACK	MACK GRANITE	2009-07
NHD 800-5504	25166303	LEFT	MACK	MACK GRANITE	2009-07
NHD 800-5505	82329127	RIGHT	VOLVO	VNL64	2012-05
NHD 800-5506	82329124	LEFT	VOLVO	VNL64	2012-05
NHD 800-5507	8082041, 0093660	RIGHT	VOLVO	VNL64	2004-95
NHD 800-5508	8082040, 0093659	LEFT	VOLVO	VNL64	2004-95

⚠ WARNING: This product can expose you to chemicals including Butadiene, which are known to the State of California to cause cancer and birth defects or other reproductive harm. For more information go to www.P65Warnings.ca.gov.



LIGHTS & ELECTRICAL ACCESSORIES

HEADLIGHTS



HEADLIGHT BEZELS



PART NO.	OEM	ORIENTATION	MAKE	MODEL	YEARS
NHD 988-5101	1661763C1, 3000077C1, 1654293C1	LEFT	INTERNATIONAL	INTERNATIONAL	2002-90
NHD 988-5102	1661764C1, 3000078C1, 1654294C1	RIGHT	INTERNATIONAL	INTERNATIONAL	2002-90
NHD 988-5201	06-32242-003, 06-32242-001	RIGHT	FREIGHTLINER	COLUMBIA	2013-04
NHD 988-5202	06-32242-002, 06-32242-000	LEFT	FREIGHTLINER	COLUMBIA	2013-04
NHD 988-5207	A06-20738-001	RIGHT	FREIGHTLINER	FLD W/ CORNERING LAMPS	2002-89
NHD 988-5208	A06-20738-000	LEFT	FREIGHTLINER	FLD W/ CORNERING LAMPS	2002-89
NHD 988-5209	A06-20711-001	RIGHT	FREIGHTLINER	CENTURY	2008-96
NHD 988-5210	A06-20711-000	LEFT	FREIGHTLINER	CENTURY	2008-96
NHD 988-5405	L18-1002R	RIGHT	KENWORTH	T300	2007-04
NHD 988-5406	L18-1002	LEFT	KENWORTH	T300	2007-04
NHD 988-5409	1607043R	RIGHT	PETERBILT	PETERBILT 377 1996-94, PETERBILT 377 A/E 1996-87	1996-87
NHD 988-5410	1607043L	LEFT	PETERBILT	PETERBILT 377 1996-94, PETERBILT 377 A/E 1996-87	1996-87
NHD 988-5501	7313-95475	LEFT/RIGHT	MACK	CL, CH, SET BACK FRONT AXLE	2005-90
NHD 988-5502	7313-67831	LEFT/RIGHT	MACK	CL, CH, STANDARD FRONT AXLE	2005-90
NHD 988-5503	25161698, 215161698	LEFT/RIGHT	MACK	RB, RD, (SINGLE SQUARE HEADLIGHT)	2002-96

⚠ WARNING: This product can expose you to chemicals including Butadiene, which are known to the State of California to cause cancer and birth defects or other reproductive harm. For more information go to www.P65Warnings.ca.gov.



HEADLIGHT SCREW

	PART NO.	OEM	MAKE	MODEL	YEARS
	NHD 218-9000	500565C91, EE34001152	INTERNATIONAL	9400, S-SERIES, PROSTAR AND 9670	2005-84
	AVAILABLE AS DISPLAY ITEM NO. NHD 901-5104CD				

⚠ WARNING: This product can expose you to chemicals including Acrylonitrile, which are known to the State of California to cause cancer and Phthalates which are known to cause birth defects or other reproductive harm. For more information go to www.P65Warnings.ca.gov.

FOG LIGHT LAMP

	PART NO.	OEM	MAKE	MODEL	YEARS
	NHD 419-9004	A06-75742-000, 06-32750-000	FREIGHTLINER	COLUMBIA	2010-04

⚠ WARNING: This product can expose you to chemicals including Butadiene, which are known to the State of California to cause cancer and birth defects or other reproductive harm. For more information go to www.P65Warnings.ca.gov.



FOG LIGHT LAMP

	PART NO.	DESCRIPTION
	GRO 07001-4	PER-LUX® 700 SERIES FOG AND DRIVING LAMPS ALL-WEATHER LAMP, SWIVEL MOUNT, CLEAR

⚠ WARNING: California Proposition 65 - Cancer and Reproductive Harm - www.P65Warnings.ca.gov.



LIGHTS & ELECTRICAL ACCESSORIES





ROUND 3/4" LED

	PART NO.	DESCRIPTION
	LIT 33050R	RED, 1 DIODE PATTERN, LAMP & GROMMET KIT
	LIT 33050Y	YELLOW, 1 DIODE PATTERN, LAMP & GROMMET KIT
	LIT 33075Y	YELLOW, 1 DIODE PATTERN, LAMP & PC-RATED GROMMET KIT WITH .180 BULLETS

⚠ WARNING: California Proposition 65 - Cancer and Reproductive Harm - www.P65Warnings.ca.gov.

ROUND 2"

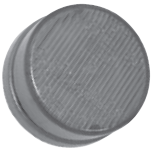
2" LED LAMPS

	PART NO.	DESCRIPTION
	LIT 30250R	RED, 2 DIODE PATTERN
	LIT 30250Y	YELLOW, 2 DIODE PATTERN
	LIT 3050	RED, 10 DIODE PATTERN
	LIT 3050A	YELLOW, 10 DIODE PATTERN
	GRO G3002	HI COUNT®, RED, 9-DIODE
	GRO G3003	HI COUNT®, YELLOW, 9-DIODE



⚠ WARNING: California Proposition 65 - Cancer and Reproductive Harm - www.P65Warnings.ca.gov.



ROUND 2" (continued)		
2" LAMPS		
	PART NO.	DESCRIPTION
	GRO 45822	RED, OPTIC LENS
	GRO 45823	YELLOW, OPTIC LENS

⚠ WARNING: California Proposition 65 - Cancer and Reproductive Harm - www.P65Warnings.ca.gov.



ROUND 2" (continued)		
2" LAMPS		
	PART NO.	DESCRIPTION
	LIT 30200R	RED (WABASH AND MONON REPLACEMENT)
	LIT 30200Y	YELLOW (WABASH AND MONON REPLACEMENT)
2" LED BEEHIVE LAMPS - FOR CAB MARKER		
	PART NO.	DESCRIPTION
	LIT 3075	RED, 10 DIODE PATTERN
	LIT 3075A	YELLOW, 10 DIODE PATTERN

⚠ WARNING: California Proposition 65 - Cancer and Reproductive Harm - www.P65Warnings.ca.gov.



LIGHTS & ELECTRICAL ACCESSORIES



ROUND 2" (continued)		
2" LED BEEHIVE LAMPS - FOR CAB MARKER		
	PART NO.	DESCRIPTION
	GRO G3092	HI COUNT®, RED, 9 DIODE
	GRO G3093	HI COUNT®, YELLOW, 9 DIODE

⚠ WARNING: California Proposition 65 - Cancer and Reproductive Harm - www.P65Warnings.ca.gov.



ROUND 2" (continued)		
2" BEEHIVE LAMPS - FOR CAB MARKER		
	PART NO.	DESCRIPTION
	LIT 30201R	RED
	LIT 30201Y	YELLOW
2-5/16" HOLE GROMMETS		
	PART NO.	DESCRIPTION
	LIT 30700	GROMMET MOUNT FOR 2" LAMPS, OPEN BACK, BLACK
	LIT 30702	GROMMET MOUNT FOR 2" LAMPS, CLOSED BACK, BLACK

⚠ WARNING: California Proposition 65 - Cancer and Reproductive Harm - www.P65Warnings.ca.gov.



ROUND 2" (continued)

2-5/16" HOLE GROMMET

	PART NO.	DESCRIPTION
	GRO 92120	OPEN GROMMET, BLACK, FITS 2" ROUND LAMPS

⚠ WARNING: California Proposition 65 - Cancer and Reproductive Harm - www.P65Warnings.ca.gov.

ROUND 2-1/2"

2" BEEHIVE LAMPS - FOR CAB MARKER

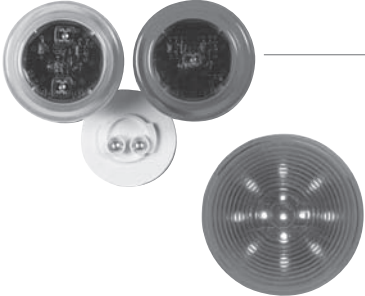
	PART NO.	DESCRIPTION
	GRO 47122	SUPERNOVA®, RED LAMP
	GRO 47123	SUPERNOVA®, YELLOW LAMP
	GRO G1032	HI COUNT®, RED LAMP
	GRO G1033	HI COUNT®, YELLOW LAMP

2-1/2" LED LAMP

	PART NO.	DESCRIPTION
	GRO 46143	SUPERNOVA®, PC RATED, YELLOW LAMP
	GRO G1002	HI COUNT®, REFLEX, RED LAMP
	GRO G1003	HI COUNT®, BUILT-IN REFLECTOR, YELLOW LAMP

⚠ WARNING: California Proposition 65 - Cancer and Reproductive Harm - www.P65Warnings.ca.gov.



LIGHTS & ELECTRICAL ACCESSORIES



ROUND 2-1/2" (continued)

2-1/2" LED LAMPS

	PART NO.	DESCRIPTION
	LIT 10250R	RED LAMP, 2 DIODE PATTERN, LED
	LIT 10250Y	YELLOW LAMP, 2 DIODE PATTERN, LED
	LIT 1050	RED LAMP, 13 DIODE PATTERN, LED
	LIT 1050A	YELLOW LAMP, 13 DIODE PATTERN, LED
	LIT 10050R	RED LAMP & GROMMET KIT, 2 DIODE PATTERN, LED

2-1/2" LAMPS

	PART NO.	DESCRIPTION
	LIT 10202R	RED LAMP, STANDARD LAMP
	LIT 10205R	RED LAMP, REFLECTORIZED
	LIT 10205Y	YELLOW LAMP, REFLECTORIZED
	LIT 10212Y	YELLOW LAMP, ABS HORIZONTAL

⚠ WARNING: California Proposition 65 - Cancer and Reproductive Harm - www.P65Warnings.ca.gov.



ROUND 2-1/2" (continued)

2-1/2" LAMPS

	PART NO.	DESCRIPTION
	GRO 45812	RED LAMP, OPTIC LENS
	GRO 45813	YELLOW LAMP, OPTIC LENS
	GRO 45832	RED LAMP, BUILT-IN REFLECTOR CLASS "A"
	GRO 45833	YELLOW LAMP, BUILT-IN REFLECTOR CLASS "A"

⚠ WARNING: California Proposition 65 - Cancer and Reproductive Harm - www.P65Warnings.ca.gov.



ROUND 2-1/2" (continued)		
2-1/2" LED BEEHIVE LAMPS - FOR CAB MARKER		
	PART NO.	DESCRIPTION
	GRO G1082	HI COUNT®, RED LENS, 9 DIODE, LED
	GRO G1083	HI COUNT®, YELLOW LENS, 9 DIODE, LED

⚠ WARNING: California Proposition 65 - Cancer and Reproductive Harm - www.P65Warnings.ca.gov.



ROUND 2-1/2" (continued)		
2-1/2" LED BEEHIVE LAMPS - FOR CAB MARKER		
	PART NO.	DESCRIPTION
	LIT 1075	RED LENS, LED
	LIT 1075A	YELLOW LENS, LED

2-1/2" BEEHIVE LAMPS - FOR CAB MARKER		
	PART NO.	DESCRIPTION
	LIT 10203R	RED LENS
	LIT 10203Y	YELLOW LENS

2-1/2" LAMP BRANCH DEFLECTOR MOUNTS

High Impact Plastic Deflector Mount

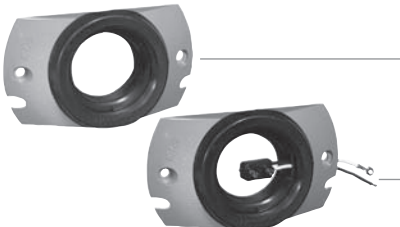
	PART NO.	DESCRIPTION
	LIT 10725	MOUNT ONLY, GRAY
	LIT 10414	MOUNT KIT - INCLUDES MOUNT, GROMMET, PLUG, GRAY

⚠ WARNING: California Proposition 65 - Cancer and Reproductive Harm - www.P65Warnings.ca.gov.



LIGHTS & ELECTRICAL ACCESSORIES



ROUND 2-1/2" (continued)		
2-25/32" GROMMET MOUNTS		
	PART NO.	DESCRIPTION
	LIT 10700	BLACK, OPEN BACK GROMMET, FLUSH MOUNTS 2-1/2" DIAMETER LAMPS
	LIT 10702	BLACK, CLOSED BACK GROMMET, FLUSH MOUNTS 2-1/2" DIAMETER LAMPS

⚠ WARNING: California Proposition 65 - Cancer and Reproductive Harm - www.P65Warnings.ca.gov.



ROUND 2-1/2" (continued)		
2-25/32" GROMMET MOUNTS		
	PART NO.	DESCRIPTION
	GRO 91400	FITS 2-1/2" ROUND LAMPS - OPEN GROMMET
	GRO 92070	FITS 2-1/2" ROUND LAMPS - CLOSED BACK GROMMET
3" GROMMET MOUNT		
	PART NO.	DESCRIPTION
	GRO 91410	FITS 2-1/2" ROUND LAMPS, OPEN GROMMET

⚠ WARNING: California Proposition 65 - Cancer and Reproductive Harm - www.P65Warnings.ca.gov.



ROUND 2-1/2" (continued)

3" GROMMET MOUNT

	<p>LIT 10704</p>	<p>BLACK, FOR 2-1/2" LAMPS, DESIGNED FOR RECESS MOUNTING</p>
---	-------------------------	--

MOUNTING BRACKETS

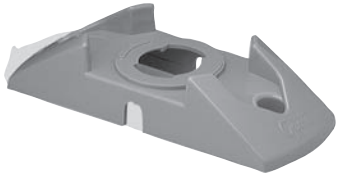

	PART NO.	DESCRIPTION
	<p>GRO 43690</p>	<p>TWIST-IN SURFACE MOUNT BRACKET, FITS 2" AND 2-1/2" LAMPS, POLYCARBONATE</p>

⚠ WARNING: California Proposition 65 - Cancer and Reproductive Harm - www.P65Warnings.ca.gov.



RECTANGULAR

RECTANGULAR LED LAMPS

	PART NO.	DESCRIPTION
	<p>GRO 47072</p>	<p>RED SUPERNOVA® SEALED TURTLEBACK® II LAMP</p>
	<p>GRO 47073</p>	<p>YELLOW SUPERNOVA® SEALED TURTLEBACK® II LAMP</p>
	<p>GRO 47092</p>	<p>RED SUPERNOVA® LAMP</p>
	<p>GRO 47093</p>	<p>YELLOW SUPERNOVA® LAMP</p>
	<p>GRO 47242</p>	<p>RED SUPERNOVA® LAMP, 3" MOUNTING CENTER</p>
	<p>GRO 47243</p>	<p>YELLOW SUPERNOVA® LAMP, 3" MOUNTING CENTER</p>





⚠ WARNING: California Proposition 65 - Cancer and Reproductive Harm - www.P65Warnings.ca.gov.





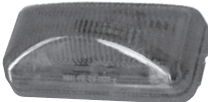

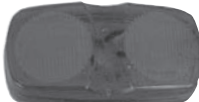

RECTANGULAR (continued)

RECTANGULAR LED LAMPS

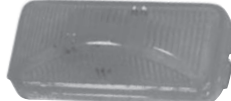
	PART NO.	DESCRIPTION
	LIT 1560	RED LAMP, 2 DIODE PATTERN, LED
	LIT 1560A	YELLOW LAMP, 3 DIODE PATTERN, LED
	LIT 19250R	RED LAMP, 2 DIODE PATTERN, STANDARD CONNECTION
	LIT 19250Y	YELLOW LAMP, 2 DIODE PATTERN, STANDARD CONNECTION, LED
	LIT 1960	RED LAMP, 4 DIODE PATTERN, STANDARD CONNECTION, LED
	LIT 1960A	AMBER LAMP, 4 DIODE PATTERN, STANDARD CONNECTION, LED
	LIT 2660	RED LAMP & LENS, 2" X 4", LED
	LIT 2660A	YELLOW LAMP & LENS, 2" X 4", LED
	LIT 35001R	RED LAMP, SLIM 3/4" WIDE DESIGN, LED LAMP KIT
	LIT 35001Y	YELLOW LAMP, SLIM 3/4" WIDE DESIGN, LED LAMP KIT
	LIT 35200R	RED LAMP, SLIM 3/4" WIDE DESIGN, LED
	LIT 35200Y	YELLOW LAMP, SLIM 3/4" WIDE DESIGN, LED

RECTANGULAR LAMPS





	PART NO.	DESCRIPTION
	LIT 1211	RED LAMP, SHOCK/ MOUNT 2 BULB PERMASTAT BULB REPLACEABLE
	LIT 1211A	YELLOW LAMP, SHOCK/ MOUNT 2 BULB PERMASTAT BULB REPLACEABLE
	LIT 15200R	RED LAMP
	LIT 15200Y	YELLOW LAMP
	LIT 19200R	RED LAMP
	LIT 19200Y	YELLOW LAMP
	LIT 21002R	RED LAMP WITH REFLECTOR & HOT WIRE
	LIT 21002Y	YELLOW LAMP WITH REFLECTOR & HOT WIRE
	LIT 29203R	RED LAMP WITH REFLEX LENS, MALE PIN
	LIT 29203Y	YELLOW LAMP WITH REFLEX LENS, MALE PIN

⚠ WARNING: California Proposition 65 - Cancer and Reproductive Harm - www.P65Warnings.ca.gov.



RECTANGULAR (continued)

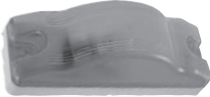

RECTANGULAR LAMPS

	PART NO.	DESCRIPTION
	GRO 46412	RED LAMP
	GRO 46413	YELLOW LAMP
	GRO 46742	DOUBLE BULB - RED LAMP
	GRO 46743	DOUBLE BULB - YELLOW LAMP
	GRO 46792	RED LAMP, TWO-BULB, SQUARE-CORNER
	GRO 46793	YELLOW LAMP, TWO-BULB, SQUARE-CORNER
	GRO 46872	RED SEALED TURTLEBACK® II LAMP, REFLEX LENS
	GRO 46873	YELLOW SEALED TURTLEBACK® II LAMP, REFLEX LENS
	GRO 53063	YELLOW LAMP, WHITE BASE, COMBINATION MARKER/ SIDE TURN LAMP

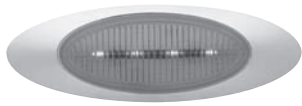
OVAL LAMPS

	PART NO.	DESCRIPTION
	GRO 45583	M1 SERIES LED, .180 MOLDED BULLET W/ BEZEL, CLEAR LENS, YELLOW

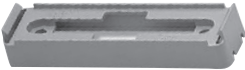
MOUNTS

	PART NO.	DESCRIPTION
	GRO 43780	<ul style="list-style-type: none"> • MOUNTING BRACKET FOR LARGE RECTANGULAR LAMPS • BRACKET ONLY, GRAY
	GRO 43390	<ul style="list-style-type: none"> • MOUNTING BRACKET FOR LARGE RECTANGULAR LAMPS • GRAY BRACKET & PIGTAIL (43780, 66981)
	GRO 43850	<ul style="list-style-type: none"> • LOW PROFILE MOUNTING BRACKET, GRAY • FOR CLEARANCE / MARKER LAMPS

⚠ WARNING: California Proposition 65 - Cancer and Reproductive Harm - www.P65Warnings.ca.gov.



LIGHTS & ELECTRICAL ACCESSORIES



RECTANGULAR (continued)

MOUNTS

	PART NO.	DESCRIPTION
	LIT 15720	DEFLECTOR MOUNT, GREY PLASTIC
	LIT 19721	LED BASE MOUNT, GREY, WITH HOT WIRE

⚠ WARNING: California Proposition 65 - Cancer and Reproductive Harm - www.P65Warnings.ca.gov.





BAR LAMP KIT

	PART NO.	DESCRIPTION
	LIT 15741R	15 SERIES ID BAR KIT, RED, STAINLESS STEEL

⚠ WARNING: California Proposition 65 - Cancer and Reproductive Harm - www.P65Warnings.ca.gov.



BAR LAMP KITS

	PART NO.	DESCRIPTION
	GRO 49082	LOW-PROFILE BAR LAMPS, RED
	GRO 49172	LED BAR LAMP US15 SERIES, RED
	GRO 49182	SUPERNOVA® LED BAR LAMP US15 SERIES, RED
	GRO 49192	15" THIN-LINE LED BAR LAMP, RED, 3 LEDS

⚠ WARNING: California Proposition 65 - Cancer and Reproductive Harm - www.P65Warnings.ca.gov.



ROUND		
4" LED LAMPS		
	PART NO.	DESCRIPTION
	LIT 44302R	RED, SUPER 44 LED STOP-TURN TAIL LAMP, 6 DIODE PATTERN
	LIT 44322R	RED, SUPER 44 LED STOP-TURN TAIL LAMP & GRAY FLANGE, 6 DIODE PATTERN
	LIT 4050	RED, SIGNAL-STAT LED STOP-TURN TAIL LAMP, 24 DIODE PATTERN
	LIT 4050A	YELLOW, SIGNAL-STAT LED F/P/T LAMP, 24 DIODE PATTERN
	LIT 44030R	RED, SUPER 44 LED STOP-TURN TAIL, 6 DIODE GROMMET KIT

⚠ WARNING: California Proposition 65 - Cancer and Reproductive Harm - www.P65Warnings.ca.gov.



ROUND (continued)		
4" LED LAMPS		
	PART NO.	DESCRIPTION
	GRO 53252	RED, SUPERNOVA® STOP-TURN TAIL, 10 DIODE PATTERN, GROMMET MOUNT, MALE PIN
	GRO 53253	YELLOW, SUPERNOVA® STOP-TURN TAIL, 10 DIODE PATTERN, GROMMET MOUNT, MALE PIN
	GRO 54332	RED, SUPERNOVA® 4" NEXGEN™ LED STOP-TURN TAIL MALE PIN
	GRO 54342	RED, GROTE SELECT™ 4" LED STOP-TURN TAIL FEMALE-PIN TERMINATION
	GRO 64002	RED, HI COUNT® STOP-TURN TAIL, 24 DIODE PATTERN

⚠ WARNING: California Proposition 65 - Cancer and Reproductive Harm - www.P65Warnings.ca.gov.



LIGHTS & ELECTRICAL ACCESSORIES



ROUND (continued)

4" SEALED LAMPS

	PART NO.	DESCRIPTION
	LIT 40202R	RED, MODEL 40 STOP-TURN TAIL LAMP
	LIT 40242R	RED, SUPER 40 STOP-TURN TAIL LAMP
	LIT 40282R	RED, ECONOMY 40 STOP-TURN TAIL LAMP
	LIT 40282Y	YELLOW, ECONOMY 40 F/P/T LAMP
	LIT 40285R	RED, ECONOMY 40 STOP-TURN TAIL LAMP, REFLECTORIZED
	LIT 49202R	RED, MALE PIN 40 STOP-TURN TAIL LAMP

⚠ WARNING: California Proposition 65 - Cancer and Reproductive Harm - www.P65Warnings.ca.gov.





ROUND (continued)

4" SEALED LAMPS

	PART NO.	DESCRIPTION
	GRO 52772	RED, TORSION MOUNT® II STOP-TURN TAIL LAMP, FEMALE PIN
	GRO 53102	RED, TORSION MOUNT® II STOP-TURN TAIL LAMP, MALE PIN
	GRO 52672	RED, TORSION MOUNT® II STOP-TURN TAIL LAMP, BUILT-IN REFLECTOR, FEMALE PIN
	GRO 52773	YELLOW, TORSION MOUNT® II STOP-TURN TAIL LAMP (FRONT PARK/TURN), FEMALE PIN
	GRO 52922	RED, ECONOMY STOP-TURN TAIL LAMP

⚠ WARNING: California Proposition 65 - Cancer and Reproductive Harm - www.P65Warnings.ca.gov.

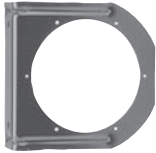
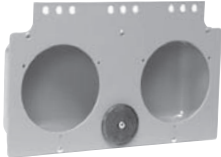

ROUND (continued)		
MOUNTS		
	PART NO.	DESCRIPTION
	LIT 10729	STEEL MOUNTING BRACKET FOR 2-1/2" LAMPS
	LIT 40720	STEEL MOUNTING BRACKET FOR 4" LAMPS, WITH FLANGE
	LIT 40725	METAL MODULE BRACKET FOR 4" LAMPS
	LIT 40756	MODEL 40 METAL STOP-TURN TAIL MODULE WITH SIDE MARKER, ROADSIDE
	LIT 40757	MODEL 40 METAL STOP-TURN TAIL MODULE WITH SIDE MARKER, CURBSIDE

⚠ WARNING: California Proposition 65 - Cancer and Reproductive Harm - www.P65Warnings.ca.gov.



ROUND (continued)		
MOUNTS		
	PART NO.	DESCRIPTION
	GRO 43572	STEEL MOUNTING BRACKET FOR 4" ROUND LAMPS, BLACK POWDER COATED
	GRO 50792	REAR LAMP MODULE WITH SIDE MARKER R.H.

⚠ WARNING: California Proposition 65 - Cancer and Reproductive Harm - www.P65Warnings.ca.gov.



LIGHTS & ELECTRICAL ACCESSORIES



ROUND (continued)		
GROMMETS		
	PART NO.	DESCRIPTION
	GRO 43253	THEFT-RESISTANT FLANGE FOR 4" ROUND LAMPS STAINLESS STEEL
	GRO 91740	4-1/2" MOUNTING GROMMET FOR 4" LAMPS, OPEN GROMMET, BLACK, PVC
	GRO 91950	4-1/2" MOUNTING GROMMET FOR 4" LAMPS, CLOSED- BACK GROMMET, BLACK, PVC
	GRO 92513	THEFT-RESISTANT FLANGE FOR 4" ROUND LAMPS CHROME-PLATED, ABS

⚠ WARNING: California Proposition 65 - Cancer and Reproductive Harm - www.P65Warnings.ca.gov.



ROUND (continued)		
GROMMETS		
	PART NO.	DESCRIPTION
	LIT 40700	4-1/2" MOUNTING GROMMET FOR 4" LAMPS, BLACK, PVC
MOUNTING COVERS FOR 4" MOUNTS		
	PART NO.	DESCRIPTION
	LIT 44700	GROMMET COVER WITH VISOR
	LIT 44701	GROMMET COVER
	LIT 44705	FLANGE COVER - STAINLESS STEEL

⚠ WARNING: California Proposition 65 - Cancer and Reproductive Harm - www.P65Warnings.ca.gov.



OVAL		
LED LAMPS		
	PART NO.	DESCRIPTION
	LIT 60250R	RED, 60 SERIES, 26 DIODE PATTERN, STOP-TURN TAIL LAMP
	LIT 6050	RED, SIGNAL-STAT LED, 24 DIODE PATTERN, STOP-TURN TAIL LAMP
	LIT 6050A	YELLOW, SIGNAL-STAT LED, 24 DIODE PATTERN, F/P/T LAMP

⚠ WARNING: California Proposition 65 - Cancer and Reproductive Harm - www.P65Warnings.ca.gov.



OVAL (continued)		
LED LAMPS		
	PART NO.	DESCRIPTION
	GRO 53962	RED, SUPERNOVA® LED OVAL STOP-TURN TAIL LAMP, GROMMET MOUNT
	GRO 53963	YELLOW, SUPERNOVA® LED OVAL STOP-TURN TAIL LAMP (AUXILIARY), GROMMET MOUNT
	GRO 54672	RED, 6" OVAL LED STOP-TURN TAIL WITH INTEGRATED BACK-UP LAMP, MALE PIN TERMINATION 12V
	GRO 54682	RED, 6" OVAL LED STOP-TURN TAIL WITH INTEGRATED BACK-UP LAMP, FEMALE PIN TERMINATION 12V
	GRO 66002	RED, HI COUNT® 56 DIODE OVAL STOP-TURN TAIL LED LAMP
SEALED LAMPS		
	PART NO.	DESCRIPTION
	GRO 52182	RED, ECONOMY OVAL STOP-TURN TAIL LAMP, FEMALE PIN TERMINATION
	GRO 52193	YELLOW, ECONOMY OVAL SIDE TURN LAMP
	GRO 52513	YELLOW, TORSION MOUNT® III OVAL SIDE TURN/MARKER LAMP, FEMALE PIN
	GRO 52892	RED, TORSION MOUNT® III STOP-TURN TAIL LAMP, FEMALE PIN
	GRO 52893	YELLOW, TORSION MOUNT® III OVAL STOP-TURN TAIL (FRONT PARK/TURN) LAMP, FEMALE PIN
	GRO 62231	CLEAR, TORSION MOUNT® III OVAL DUAL SYSTEM BACKUP LAMP, FEMALE PIN

⚠ WARNING: California Proposition 65 - Cancer and Reproductive Harm - www.P65Warnings.ca.gov.





OVAL (continued)

SEALED LAMPS

	PART NO.	DESCRIPTION
	LIT 60202R	RED, SUPER 60 STOP-TURN TAIL LAMP
	LIT 60202Y	YELLOW, SUPER 60 F/P/T LAMP
	LIT 69202Y	YELLOW, MALE PIN SIDE TURN & MARKER CLEARANCE 6" LAMP
	LIT 60215Y	YELLOW, 60 SERIES SIDE TURN & MARKER CLEARANCE 6" LAMP

MOUNTS

	PART NO.	DESCRIPTION
	LIT 60700	GROMMET MOUNT, OPEN BACK, FOR 60 SERIES PRODUCTS
	LIT 60704	GROMMET MOUNT, CLOSED BACK, FOR 60 SERIES LED APPLICATIONS
	LIT 60709	GROMMET MOUNT, SEMI-CLOSED BACK, FOR 60 SERIES PRODUCTS
	LIT 60720	MOUNTING BRACKET, STEEL W/ FLANGE, FOR 60 SERIES PRODUCTS
	LIT 60729	MOUNTING BRACKET, STEEL FOR 60 SERIES BRACKET

⚠ WARNING: California Proposition 65 - Cancer and Reproductive Harm - www.P65Warnings.ca.gov.









OVAL (continued)

SEALED LAMPS

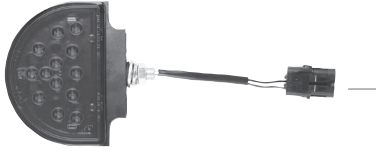
	PART NO.	DESCRIPTION
	GRO 43100	MOUNTING BRACKET FOR 6" OVAL LAMPS, STEEL, BLACK
	GRO 43362	MOUNTING BRACKET FOR 6" OVAL LAMPS, STEEL, BLACK, 90
	GRO 92420	OPEN GROMMET FOR 6" OVAL LAMPS, FITS 2-1/2" X 6-3/4" SIZE HOLE, BLACK, PVC
	GRO 92720	CLOSED BACK GROMMET FOR 6" OVAL LAMPS, FITS 2-1/2" X 6-3/4" SIZE HOLE, BLACK, PVC

⚠ WARNING: California Proposition 65 - Cancer and Reproductive Harm - www.P65Warnings.ca.gov.



MISCELLANEOUS LIGHTS		
BACK-UP LAMPS		
	PART NO.	DESCRIPTION
	GRO 56150-5	LED AMBER/AMBER WARNING - PEDESTAL
	GRO 56170-5	LED AMBER WARNING AND RED STOP-TURN TAIL LAMPS PEDESTAL
	GRO 56160-5	LED AMBER/AMBER WARNING - SURFACE
	GRO 56180-5	LED AMBER WARNING AND RED STOP-TURN TAIL LAMPS SURFACE
	GRO 61E41	DOME LAMP LED 4" MALE PIN 12V, 0.6A
	GRO 62171	<ul style="list-style-type: none"> FROSTED CLEAR, 4", TORSION MOUNT® II, DUAL SYSTEM, BACK-UP LAMP REQUIRES TWO LAMPS TO MEET BACK-UP FUNCTION
	GRO 62271	CLEAR, 4", TORSION MOUNT® II, SINGLE SYSTEM, BACK-UP LAMP, FEMALE PIN, 12V, 2.1A
	GRO 62691	CLEAR, 4" DUAL SYSTEM LED BACK-UP LAMP, FEMALE-PIN 12V, 0.55A
	GRO G5082-5	HI COUNT® LED STOP-TURN TAIL RED, R.H., WITHTOUT SIDEMARKER
	GRO G5092-5	HI COUNT® LED STOP-TURN TAIL RED, L.H. WITHOUT SIDEMARKER, WITH LICENSE WINDOW

⚠ WARNING: California Proposition 65 - Cancer and Reproductive Harm - www.P65Warnings.ca.gov.



LIGHTS & ELECTRICAL ACCESSORIES



MISCELLANEOUS LIGHTS (continued)

BACK-UP LAMPS

	PART NO.	DESCRIPTION
	GRO G5300	HI-COUNT 2 SIDED LED, RED/YELLOW
	GRO G5530	HIGH COUNT 2 SIDED LED WITH SIDE MARKER, L.H., RED/YELLOW
	GRO G5540	HIGH COUNT 2 SIDED LED WITH SIDE MARKER, R.H., RED/YELLOW
	GRO G5543	HIGH COUNT 2 SIDED LED WITH SIDE MARKER W/ PACKARD CONNECTOR, YELLOW/YELLOW

⚠ WARNING: California Proposition 65 - Cancer and Reproductive Harm - www.P65Warnings.ca.gov.



MISCELLANEOUS LIGHTS (continued)

BACK-UP LAMPS

	PART NO.	DESCRIPTION
	LIT 40204	MODEL 40, 4" ROUND, SEALED, 12V, CLEAR
	LIT 4060C	4" ROUND, LED 24 DIODE PATTERN, CLEAR
	LIT 60204C	SUPER 60 SEALED, OVAL, CLEAR
	LIT 6060C	OVAL, LED 24 DIODE PATTERN, CLEAR
	LIT 15011	KIT, 15 SERIES, INCANDESCENT LAMP & GRAY BRACKET KIT, 12V

⚠ WARNING: California Proposition 65 - Cancer and Reproductive Harm - www.P65Warnings.ca.gov.



MISCELLANEOUS LIGHTS (continued)

LICENSE LAMPS

	PART NO.	DESCRIPTION
	LIT 15208	15 SERIES RECTANGULAR SEALED, CLEAR, 12V
	LIT 21204C	SUPER 21, RECTANGULAR SEALED, CLEAR
	LIT 26335	26 SERIES BULB REPLACEABLE, GREY
	LIT 36041C	36 SERIES LED LICENSE LAMP KIT GRAY BRACKET

⚠ WARNING: California Proposition 65 - Cancer and Reproductive Harm - www.P65Warnings.ca.gov.



MISCELLANEOUS LIGHTS (continued)

LICENSE LAMPS

	PART NO.	DESCRIPTION
	GRO 60001	RESEALABLE LICENSE LAMP, GRAY
	GRO 60261	SMALL RECTANGULAR LICENSE LAMP, CLEAR
	GRO 60280	SMALL RECTANGULAR CLEAR LICENSE LAMP (60261), WITH GRAY MOUNTING BRACKET (43830)
	GRO 60291	RECTANGULAR LICENSE LAMP, CLEAR, DOUBLE BULB
	GRO 60381	SUPERNOVA® LED LICENSE LAMP, GRAY
	GRO 60671	MICRONOVA® LED LICENSE LAMP REPLACEMENT LAMP, CLEAR
	GRO 60681	MICRONOVA® LED LICENSE LAMP, VERTICAL MOUNT, GRAY, REPLACEMENT LAMP (CLEAR, LED): 60671, GRAY MOUNTING BRACKET: 43960
	GRO 60721	MICRONOVA® DOT LED LICENSE LAMP WITH HOODED GROMMET, CLEAR

⚠ WARNING: California Proposition 65 - Cancer and Reproductive Harm - www.P65Warnings.ca.gov.





LIGHTS & ELECTRICAL ACCESSORIES



MISCELLANEOUS LIGHTS (continued)

UTILITY LAMPS



	PART NO.	DESCRIPTION
	GRO 60271	SMALL RECTANGULAR UTILITY LAMP, CLEAR
	GRO 60411	RECTANGULAR LED UTILITY LAMP, CLEAR
	GRO 60421	SMALL RECTANGULAR LED UTILITY LAMP, CLEAR

⚠ WARNING: California Proposition 65 - Cancer and Reproductive Harm - www.P65Warnings.ca.gov.





MISCELLANEOUS LIGHTS (continued)

UTILITY LAMPS

	PART NO.	DESCRIPTION
	LIT 15200C	15 SERIES, RECTANGULAR SEALED, 12V, CLEAR
	LIT 19200C	19 SERIES, RECTANGULAR SEALED, CLEAR

DOMES LAMPS

	PART NO.	DESCRIPTION
	LIT 44438C	44 SERIES, LED 6 DIODE PATTERN, SURFACE MOUNT DOME W/ SWITCH, HARDWIRED
	LIT 80351	CHROME HOUSING, BULB REPLACEABLE, MODEL 80
	LIT 80350	CHROME HOUSING W/SWITCH, BULB REPLACEABLE, MODEL 80
	LIT 80255C	WITH MOTION SENSOR, LED 10 DIODE PATTERN

⚠ WARNING: California Proposition 65 - Cancer and Reproductive Harm - www.P65Warnings.ca.gov.



MISCELLANEOUS LIGHTS (continued)

LICENSE & UTILITY LAMP

	PART NO.	DESCRIPTION
	LIT 15205	15 SERIES LED SEALED 3 DIODE PATTERN, CLEAR, 12V

LICENSE, INSTRUMENT OR STEP LIGHTING

	PART NO.	DESCRIPTION
	LIT 26330	26 SERIES, BULB REPLACEABLE, CLEAR

INTERIOR LAMP

	PART NO.	DESCRIPTION
	LIT 80251C	SUPER 80, LED 10 DIODE PATTERN

⚠ WARNING: California Proposition 65 - Cancer and Reproductive Harm - www.P65Warnings.ca.gov.



MISCELLANEOUS LIGHTS (continued)

INTERIOR LAMP

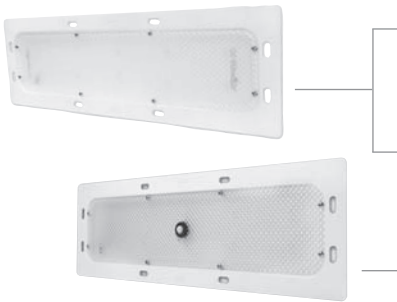
	PART NO.	DESCRIPTION
	GRO 61261	LED WHITELIGHT™ RECESSED-MOUNT 18" DOME LAMP 10 DIODES, HIGH OUTPUT VERSION, 800 LUMENS, WHITE
	GRO 61291	LED WHITELIGHT™ RECESSED-MOUNT 18" DOME LAMP 6 DIODES, MOTION SENSOR, 940 LUMENS, WHITE
	GRO 61H91	LED WHITELIGHT™ RECESSED-MOUNT DOME 18" LAMP STANDARD OUTPUT 6 DIODES, MOTION SENSOR, 940 LUMENS, WHITE









⚠ WARNING: California Proposition 65 - Cancer and Reproductive Harm - www.P65Warnings.ca.gov.



LIGHTS & ELECTRICAL ACCESSORIES



PIGTAILS

	PART NO.	DESCRIPTION
	GRO 66815	<ul style="list-style-type: none"> • STOP-TURN TAIL THREE-WIRE PLUG-IN PIGTAILS, FOR MALE PIN LAMPS • 6" LONG, GROUND RETURN, SLIM-LINE .180 MALE
	GRO 66843	<ul style="list-style-type: none"> • STOP-TURN TAIL, THREE-WIRE 90° PLUG-IN PIGTAILS FOR FEMALE PIN LAMPS • 18" LONG, CHASSIS GROUND, BLUNT CUT WIRES, STAR RING TERMINALS
	GRO 66850	<ul style="list-style-type: none"> • SEALED MARKER LAMP PIGTAILS, DOUBLE SEAL • 6" LONG, CHASSIS GROUND
	GRO 66861	<ul style="list-style-type: none"> • HARD-SHELL CONNECTOR PIGTAILS DUAL FUNCTION • 11" LONG, CHASSIS GROUND, BLUNT CUT WIRES
	GRO 66910	<ul style="list-style-type: none"> • TURTLEBACK® II DOUBLE-SEAL LAMP PIGTAILS • 6" LONG, CHASSIS GROUND, SLIM-LINE .180 MALE
	GRO 66931	<ul style="list-style-type: none"> • THIN-LINE LED PIGTAILS • 6" LONG, GROUND RETURN
	GRO 67000	<ul style="list-style-type: none"> • STOP-TURN TAIL THREE-WIRE PLUG-IN PIGTAILS FOR FEMALE PIN LAMPS • 11-1/2" LONG, CHASSIS GROUND, BLUNT CUT
	GRO 67001	<ul style="list-style-type: none"> • SEALED MARKER LAMP PIGTAILS DOUBLE SEAL • 6" LONG, RING TERMINAL GROUND, BLUNT CUT WIRE
	GRO 67002	<ul style="list-style-type: none"> • STOP-TURN TAIL THREE-WIRE PLUG-IN PIGTAILS, FOR MALE PIN LAMPS • 11" LONG, CHASSIS GROUND, BLUNT CUT

⚠ WARNING: California Proposition 65 - Cancer and Reproductive Harm - www.P65Warnings.ca.gov.



PIGTAILS (continued)		
	PART NO.	DESCRIPTION
	GRO 67010	<ul style="list-style-type: none"> TWO-WIRE, PLUG-IN PIGTAILS FOR FEMALE PIN LAMPS 11-1/2" LONG, CHASSIS GROUND, BLUNT CUT WIRE
	GRO 67050	<ul style="list-style-type: none"> SEALED MARKER LAMP PIGTAILS, SINGLE SEAL 6" LONG, RING TERMINAL GROUND, BLUNT CUT WIRE
	GRO 67090	<ul style="list-style-type: none"> UNIVERSAL 3-WIRE 90° PLUG-IN PIGTAIL FOR FEMALE-PIN LAMPS 13" LONG, CHASSIS GROUND, BLUNT-CUT WIRES
	GRO 68380	<ul style="list-style-type: none"> TWIST-IN SOCKET PIGTAIL 9-1/2" LONG, WITH 194 BULB
	GRO 68680	<ul style="list-style-type: none"> METRI-PACK® PLUG-IN SEALED PIGTAIL 20" LONG, 14 GAUGE, FITS 4/5 WIRE
	GRO 84-1006	<ul style="list-style-type: none"> HEADLAMP SOCKET - 2 OR 3 TERMINAL SEALED BEAM 12" LEAD WIRE

⚠ WARNING: California Proposition 65 - Cancer and Reproductive Harm - www.P65Warnings.ca.gov.



LIGHTS & ELECTRICAL ACCESSORIES



CORROSION PREVENTION		
	PART NO.	DESCRIPTION
	LIT 97940	<ul style="list-style-type: none"> NYK-77 COMPOUND, 8 OZ CAN FOR ELECTRICAL CONTACTS, SWITCHES & JUNCTION BOXES
	LIT 97944	<ul style="list-style-type: none"> NYK-77 COMPOUND, 2 OZ TUBE FOR ELECTRICAL CONTACTS, SWITCHES & JUNCTION BOXES
	LIT 97946-3	<ul style="list-style-type: none"> MULTI-PURPOSE MAINTENANCE SPRAY, 14 OZ FOR USE ON CONNECTORS INCLUDING ABS, 4-13 WAY PLUGS AND SOCKETS, BATTERY TERMINALS AND MORE.

⚠ WARNING: California Proposition 65 - Cancer and Reproductive Harm - www.P65Warnings.ca.gov.



LED WORK LAMPS

TRILLIANT® LED WHITELIGHT™ HIGH OUTPUT WORK LAMPS



PART NO.	PATTERN	VOLTAGE	AMP DRAW	OUTPUT LUMENS
GRO 63571	SPOT	12/24	4.2/2.1	3274
GRO 63581	FLOOD	12/24	4.2/2.1	3274
GRO 63591	TRAPEZOID	12/24	4.2/2.1	3274
GRO 63761	WIDE FLOOD	12/24	4.2/2.1	3274
GRO 63E41	FLOOD, WITH REFLECTOR	12/24	4.2/2.1	4100
GRO 63J01	FLOOD	12/24	3/1.5	2500
GRO 63J11	WIDE FLOOD	12/24	3/1.5	2500
GRO 63J21	FLOOD	12/24	3/1.5	2500
GRO 63J31	WIDE FLOOD	12/24	3/1.5	2500

TRILLIANT® MINI LED WHITELIGHT™ WORK LAMPS



PART NO.	DESCRIPTION
GRO 63601-5	FORWARD LIGHTING, CLEAR, MINI WORK LAMP, LED, SPOT PATTERN
GRO 63610	FORWARD LIGHTING, CLEAR MINI FLUSH MOUNT LED WORK LAMP, FLOOD PATTERN
GRO 63611-5	FORWARD LIGHTING, CLEAR, MINI WORK LAMP, LED, FLOOD PATTERN
GRO 63621-5	FORWARD LIGHTING, CLEAR, MINI WORK LAMP, LED, TRAPEZOID PATTERN
GRO 63731	FORWARD LIGHTING, CLEAR, WORK LAMP, LED, SPOT PATTERN, 24 VOLT
GRO 63741-5	FORWARD LIGHTING, CLEAR, WORK LAMP, LED, FLOOD PATTERN, 24 VOLT
GRO 63751-5	FORWARD LIGHTING, CLEAR, WORK LAMP, LED, TRAPEZOID PATTERN, 24 VOLT

⚠ WARNING: California Proposition 65 - Cancer and Reproductive Harm - www.P65Warnings.ca.gov.



LED WORK LAMPS (continued)

TRILLIANT® MINI LED WHITELIGHT™ WORK LAMPS



PART NO.	DESCRIPTION
GRO 63601-5	FORWARD LIGHTING, CLEAR, MINI WORK LAMP, LED, SPOT PATTERN
GRO 63610	FORWARD LIGHTING, CLEAR MINI FLUSH MOUNT LED WORK LAMP, FLOOD PATTERN
GRO 63611-5	FORWARD LIGHTING, CLEAR, MINI WORK LAMP, LED, FLOOD PATTERN
GRO 63621-5	FORWARD LIGHTING, CLEAR, MINI WORK LAMP, LED, TRAPEZOID PATTERN
GRO 63731	FORWARD LIGHTING, CLEAR, WORK LAMP, LED, SPOT PATTERN, 24 VOLT
GRO 63741-5	FORWARD LIGHTING, CLEAR, WORK LAMP, LED, FLOOD PATTERN, 24 VOLT
GRO 63751-5	FORWARD LIGHTING, CLEAR, WORK LAMP, LED, TRAPEZOID PATTERN, 24 VOLT

TRILLIANT® T36 LED WHITELIGHT™ CONVERSION BULBS



PART NO.	DESCRIPTION
GRO 63821-5	FORWARD LIGHTING, CLEAR, T36 CONVERSION BULB, TRACTOR
GRO 63831-5	FORWARD LIGHTING, CLEAR, T36 CONVERSION BULB, FLOOD
GRO 63861-5	FORWARD LIGHTING, CLEAR, T36 CONVERSION BULB, TRACTOR W/BRACKET
GRO 63871-5	FORWARD LIGHTING, CLEAR, T36 CONVERSION BULB, FLOOD W/BRACKET
GRO 63F31	TRILLIANT® CUBE LED WORK LAMP DEUSTCH, FLOOD
GRO 63F51	TRILLIANT® CUBE LED WORK LAMP, WIDE FLOOD
GRO 63F61	TRILLIANT® CUBE LED WORK LAMP, FLOOD
GRO 63F71	TRILLIANT® CUBE LED WORK LAMP, WIDE FLOOD
GRO 63G01	TRILLIANT® OVAL LED WORK LAMP DEUSTCH, 1200 LUMEN, FLOOD
GRO 63G11	TRILLIANT® OVAL LED WORK LAMP DEUSTCH, WIDE FLOOD, 1200 LUMENS

⚠ WARNING: California Proposition 65 - Cancer and Reproductive Harm - www.P65Warnings.ca.gov.



LIGHTS & ELECTRICAL ACCESSORIES



LED WORK LAMPS (continued)

TRILLIANT® CUBE LED WHITELIGHT™



PART NO.	DESCRIPTION
GRO 63981-5	SUPERSEAL TRACTORPLUS™ TRILLIANT CUBE WORK LAMP
GRO 63991-5	SUPERSEAL WIDEFLOOD TRILLIANT CUBE WORK LAMP
GRO 64H01-5	GROTE SELECT™ LED FLOOD LAMP FLOOD, HARDWIRE

⚠ WARNING: California Proposition 65 - Cancer and Reproductive Harm - www.P65Warnings.ca.gov.



LED WORK LAMPS (continued)



PART NO.	DESCRIPTION
LIT 80220	LED PAR 36 WORK LAMP, 9-36V
LIT 81360	4" WORK LAMP, 6 DIODE PATTERN, 12V, BLACK, RUGGED ALL PURPOSE WORK LAMP
LIT 81365	4" WORK LAMP, 6 DIODE PATTERN, 12V, CHROME, RUGGED ALL PURPOSE WORK LAMP
LIT 8140	SIGNAL-STAT 3" ROUND LAMP FLOOD, 4 LED, 9V-36V, 700 LUMEN
LIT 81500	RECTANGULAR LED WORK LAMP, 4.7", 2850 LUMEN
LIT 8155	RECTANGULAR, 8 DIODE, IDEAL FOR LIGHT UTILITY, CONSTRUCTION, AGRICULTURAL, AIRPORT & TOW TRUCKS, STATE & HIGHWAY DEPARTMENTS
LIT 8160	RECTANGULAR, 10 DIODE, IDEAL FOR LIGHT UTILITY, CONSTRUCTION, AGRICULTURAL, AIRPORT & TOW TRUCKS, STATE & HIGHWAY DEPARTMENTS
LIT 8170	RECTANGULAR, 5", 9 DIODE, IDEAL FOR LIGHT UTILITY, CONSTRUCTION, AGRICULTURAL, AIRPORT & TOW TRUCKS, STATE & HIGHWAY DEPARTMENTS
LIT 8180	SIGNAL-STAT 5-1/2" OVAL LAMP FLOOD, 8 LED, 9V-36V, 1400 LUMEN

⚠ WARNING: California Proposition 65 - Cancer and Reproductive Harm - www.P65Warnings.ca.gov.



HALOGEN WORK LAMPS		
	PART NO.	DESCRIPTION
	GRO 63151-5	RECTANGULAR HALOGEN WORK LAMP FLOOD
	GRO 63161-5	RECTANGULAR HALOGEN WORK LAMP SPOT
	GRO 63171-5	RECTANGULAR HALOGEN WORK LAMP TRAPEZOID, 24V
	GRO 63241-5	RECTANGULAR HALOGEN WORK LAMP FLOOD, 24V

⚠ WARNING: California Proposition 65 - Cancer and Reproductive Harm - www.P65Warnings.ca.gov.



RETRO-REFLECTIVE TAPE REFLECTORS		
	PART NO.	DESCRIPTION
	LIT 98175R	RED, 3", ROUND
	LIT 98175Y	YELLOW, 3", ROUND
	LIT 98176R	RED, 2" X 3-1/2", RECTANGULAR
	LIT 98176Y	YELLOW, 2" X 3-1/2", RECTANGULAR

⚠ WARNING: California Proposition 65 - Cancer and Reproductive Harm - www.P65Warnings.ca.gov.



LIGHTS & ELECTRICAL ACCESSORIES



OVAL REFLECTORS

- Oval two hole reflectors
- Can be used as stick-on by peeling off back paper or can be mounted with two screws

	PART NO.	DESCRIPTION
	LIT 54	RED
	LIT 54A	YELLOW

⚠ WARNING: California Proposition 65 - Cancer and Reproductive Harm - www.P65Warnings.ca.gov.

ROUND REFLECTORS

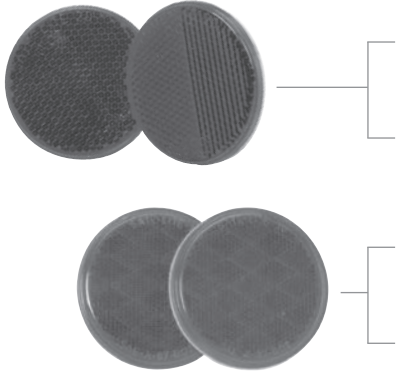
	PART NO.	DESCRIPTION
	LIT 45	RED, 2-3/16", PERMANENT ADHESIVE BACKING
	LIT 45A	YELLOW, 2-3/16", PERMANENT ADHESIVE BACKING
	LIT 47	RED, 3-3/16", STICK-ON
	LIT 47A	YELLOW, 3-3/16", STICK-ON

⚠ WARNING: California Proposition 65 - Cancer and Reproductive Harm - www.P65Warnings.ca.gov.



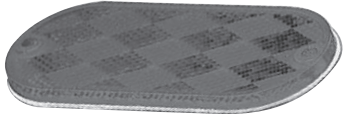

OVAL REFLECTORS

	PART NO.	DESCRIPTION
	GRO 41032	RED, STICK-ON/SCREW MOUNTABLE, 4-3/8" X 1-7/8"
	GRO 41033	YELLOW, STICK-ON/SCREW MOUNTABLE, 4-3/8" X 1-7/8"

⚠ WARNING: California Proposition 65 - Cancer and Reproductive Harm - www.P65Warnings.ca.gov.

ROUND REFLECTORS

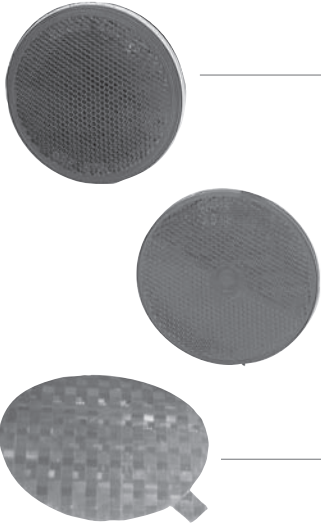
	PART NO.	DESCRIPTION
	GRO 40062	RED, SEALED 3" ROUND STICK-ON REFLECTOR
	GRO 40063	YELLOW, SEALED 3" ROUND STICK-ON REFLECTOR
	GRO 41012	<ul style="list-style-type: none"> • RED, 2", SEALED, CENTER-MOUNT REFLECTOR • SIMPLE INSTALLATION WITH SINGLE #10 SCREW
	GRO 41013	<ul style="list-style-type: none"> • YELLOW, 2", SEALED, CENTER-MOUNT REFLECTOR • SIMPLE INSTALLATION WITH SINGLE #10 SCREW
	GRO 41142	RED, STICK-ON TAPE REFLECTORS 2-15/16" ROUND
	GRO 41143	YELLOW, STICK-ON TAPE REFLECTORS 2-15/16" ROUND

⚠ WARNING: California Proposition 65 - Cancer and Reproductive Harm - www.P65Warnings.ca.gov.

RECTANGULAR REFLECTORS

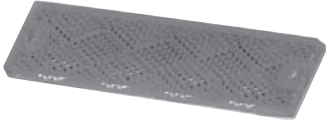
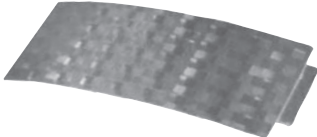
	PART NO.	DESCRIPTION
	GRO 40132	RED, MINI STICK-ON / SCREW-MOUNT RECTANGULAR REFLECTOR
	GRO 40133	YELLOW, MINI STICK-ON / SCREW-MOUNT RECTANGULAR REFLECTOR
	GRO 41152	RED, STICK-ON TAPE REFLECTOR, 1-11/16" X 4-1/4"
	GRO 41153	YELLOW, STICK-ON TAPE REFLECTOR, 1-11/16" X 4-1/4"

⚠ WARNING: California Proposition 65 - Cancer and Reproductive Harm - www.P65Warnings.ca.gov.



STROBE LIGHTS		
	PART NO.	DESCRIPTION
	LIT 44102Y	LED 44 SERIES STROBE GROMMET MOUNT YELLOW
	LIT 60120Y	LED 60 SERIES STROBE, GROMMET MOUNT KIT YELLOW

⚠ WARNING: California Proposition 65 - Cancer and Reproductive Harm - www.P65Warnings.ca.gov.

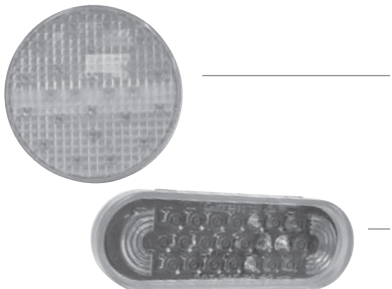

STROBE LIGHTS (continued)		
	PART NO.	DESCRIPTION
	GRO 77353	<ul style="list-style-type: none"> • YELLOW, 4" ROUND LED STROBE LIGHT • FUNCTIONS AS EITHER A DUAL FLASH STROBE OR A QUAD FLASH STROBE
	GRO 77363	<ul style="list-style-type: none"> • YELLOW, OVAL LED STROBE LIGHT • FUNCTIONS AS EITHER A DUAL FLASH STROBE OR A QUAD FLASH STROBE

⚠ WARNING: California Proposition 65 - Cancer and Reproductive Harm - www.P65Warnings.ca.gov.

STROBE BEACON		
	PART NO.	DESCRIPTION
	GRO 77123	<ul style="list-style-type: none"> • YELLOW, MEDIUM PROFILE CLASS II PLASTIC BASE STROBE • FRENSEL LENS PROVIDES 360° COVERAGE • INCLUDES 1" PIPE-MOUNT AND FLANGE-MOUNT • CHOOSE DOUBLE (7 JOULES) OR QUAD (10 JOULES) FLASH • 80 (DOUBLE) OR 65 (QUAD) FLASHES PER MINUTE • REVERSE POLARITY, VOLTAGE, AND SURGE PROTECTED

⚠ WARNING: California Proposition 65 - Cancer and Reproductive Harm - www.P65Warnings.ca.gov.



LED BEACONS		
	PART NO.	DESCRIPTION
	LIT 92564Y	LED 360 STROBE LOW PROFILE, YELLOW WITH YELLOW LENS
	LIT 92565Y	LED SOLID-STATE WARNING LAMP, MEDIUM PROFILE YELLOW

⚠ WARNING: California Proposition 65 - Cancer and Reproductive Harm - www.P65Warnings.ca.gov.



LED BEACONS (continued)		
	PART NO.	DESCRIPTION
	GRO 76253	GROTE CLASS I LED BEACON YELLOW, LOW PROFILE, 12V
	GRO 77463	LED DIRECTIONAL WARNING LAMP YELLOW
	LIT 92565-Y	GROTE 360 DEGREE LED STROBE LIGHT YELLOW
	GRO 77933	VERTEX™ HIDE-AWAY STROBE LAMP YELLOW
	GRO 78853	MEDIUM PROFILE CLASS II LED BEACON PERMANENT MOUNT, AMBER

⚠ WARNING: California Proposition 65 - Cancer and Reproductive Harm - www.P65Warnings.ca.gov.



LIGHTS & ELECTRICAL ACCESSORIES



CONSPICUITY TAPE

	PART NO.	DESCRIPTION
	GRO 40641	SILVER, 2" X 150' ROLL
	GRO 40650	ALTERNATING 7" SILVER / 11" RED - 2" X 150' ROLL - 7-YEAR WARRANTY
	GRO 41160	ALTERNATING 7" SILVER / 11" RED - 2" X 150' ROLL - 3-YEAR WARRANTY
	GRO 41050	2" X 150' ROLL, ALTERNATING 6" SILVER / 6" RED (STANDARD MANAC)
	GRO 41133	2" X 150' ROLL, YELLOW, FOR AGRICULTURAL VEHICLES, MANDATORY IN QUEBEC

⚠ WARNING: California Proposition 65 - Cancer and Reproductive Harm - www.P65Warnings.ca.gov.

MINI LIGHT BARS

	PART NO.	DESCRIPTION
	GRO 76683	ROTOLED™ CLASS I LED HYBRID BEACON, AMBER
	GRO 76813	15" ROTATING LOW PROFILE BAR LAMP, YELLOW
	GRO 76943	17" LOW-PROFILE LED MINI LIGHTBAR CLEAR LENS, YELLOW
	GRO 76953	17" LOW-PROFILE LED MINI LIGHTBAR CIGARETTE LIGHTER ADAPTER, CLEAR LENS, YELLOW
	GRO 76963	FLEXIBLE-BASE STROBE LAMP, YELLOW

⚠ WARNING: California Proposition 65 - Cancer and Reproductive Harm - www.P65Warnings.ca.gov.



MINI LIGHT BARS (continued)

	PART NO.	DESCRIPTION
	GRO 76983	17" LOW-PROFILE LED MINI LIGHTBAR PERMANENT MOUNT, YELLOW
	GRO 76993	17" LOW-PROFILE LED MINI LIGHTBAR, YELLOW
	GRO 77103	MIGHTY MINI STROBE SINGLE FLASH, YELLOW
	GRO 77163	15" ROTATING MINI-BAR LAMP, YELLOW
	GRO 77913	360° PORTABLE BATTERY OPERATED LED WARNING LIGHT, YELLOW

⚠ WARNING: California Proposition 65 - Cancer and Reproductive Harm - www.P65Warnings.ca.gov.

ABS POWER CORDS

	PART NO.	DESCRIPTION
	GRO 87101	15' LENGTH, 12" LEADS, 4/12 GA, GREEN

⚠ WARNING: California Proposition 65 - Cancer and Reproductive Harm - www.P65Warnings.ca.gov.

COILED AIR HOSES

	PART NO.	DESCRIPTION
	GRO 81-0015	15' LENGTH, 12" LEADS, RED AND BLUE, 2-PACK
	GRO 81-0015-40	15' LENGTH, 12" & 40" LEADS, RED AND BLUE, 2-PACK

⚠ WARNING: California Proposition 65 - Cancer and Reproductive Harm - www.P65Warnings.ca.gov.



LIGHTS & ELECTRICAL ACCESSORIES



ELECTRICAL CABLE ASSEMBLIES (continued)

ABS LETRACOIL™ - 1/8, 2/10 & 4/12 GA - ABS APPLICATIONS

- Recommended for ABS applications and trailers with high voltage demands
- Flexible from -82°F to 195°F (-63°C to 91°C)
- Excellent recoil memory, chemical & abrasion resistance

	PART NO.	DESCRIPTION
	PHI 30-9620	15', WITH 2 UNBREAKABLE PERMAPLUGS™*
	PHI 30-9920	15', 48" LEAD, WITH 2 UNBREAKABLE PERMAPLUGS™*
	PHI 30-9924	15', 48" LEAD, WITH QUICK-CHANGE PLUGS (QCP™)*

ABS PERMACOIL™ - 1/8, 2/10 & 4/12 GA - ABS APPLICATIONS

- Recommended for ABS applications
- Flexible from -87°F to 150°F (-66°C to 66°C)
- Good recoil memory, chemical & abrasion resistance

	PART NO.	DESCRIPTION
	PHI 30-4621	15', WITH ZINC DIE-CAST PLUGS*
	PHI 30-4921	15', 48" LEAD, WITH ZINC DIE-CAST PLUGS*
	PHI 30-4951	20', WITH ZINC DIE-CAST PLUGS*

PERMACOIL™

- For standard 7-way applications, NON-ABS equipped trailers with minimal voltage demands
- Flexible from -87°F to 150°F (-66°C to 66°C)
- Good recoil memory, chemical & abrasion resistance

1/10 & 6/12 GA - NON-ABS APPLICATIONS

	PART NO.	DESCRIPTION
	PHI 22-4621	15', WITH ZINC DIE-CAST PLUGS*
	PHI 22-4721	15', 72" LEAD, WITH ZINC DIE-CAST PLUGS*

1/12 & 6/14 GA - NON-ABS APPLICATIONS

	PART NO.	DESCRIPTION
	PHI 24-4621	15', WITH ZINC DIE-CAST PLUGS*
	PHI 24-4721	15', 72" LEAD, WITH ZINC DIE-CAST PLUGS*
	PHI 24-4951	20', WITH ZINC DIE-CAST PLUGS*

MANY SIZES & OPTIONS AVAILABLE * Working Length - as measured by pull force J2222; length of actual cable is significantly longer

⚠ WARNING: California Proposition 65 - Cancer and Reproductive Harm - www.P65Warnings.ca.gov.

ELECTRICAL CABLE ASSEMBLIES (continued)

ISOCOIL™ - 1/8, 2/10 & 4/12 GA - ABS APPLICATIONS

- For ISO/auxiliary applications
- Twisted pair brown & green wires to avoid electrical interference
- Male ground pin to prevent mis-connections
- Heavy-duty, reinforced zinc die-cast housing

	PART NO.	DESCRIPTION
	PHI 31-9623	15', WITH ZINC DIE-CAST PLUGS*
	PHI 31-9923	15', 48" LEAD, WITH 2 ZINC DIE-CAST PLUGS*

DURACOIL - 1/10 & 6/12 GA - NON-ABS APPLICATIONS

- For standard 7-way applications, NON-ABS equipped trailers
- Flexible from -82°F to 195°F (-63°C to 91°C)
- Excellent recoil memory, chemical & abrasion resistance

	PART NO.	DESCRIPTION
	PHI 22-9721	15', 72" LEAD, WITH ZINC DIE-CAST PLUGS*
	PHI 22-9921	15', 48" LEAD, WITH ZINC DIE-CAST PLUGS*

STRAIGHT ABS LECTRAFLEX™

- Spring-wrapped compression contact pins
- Chemical & abrasion resistant

	PART NO.	DESCRIPTION
	PHI 30-2050	12', WITH UNBREAKABLE PERMAPLUGS™
	PHI 30-2070	15', WITH UNBREAKABLE PERMAPLUGS™
	PHI 30-2051	12', WITH ZINC DIE-CAST PLUGS
	PHI 30-2071	15', WITH ZINC DIE-CAST PLUGS

STRAIGHT DURAFLEX™ - 1/10 & 6/10 GA - NON-ABS APPLICATIONS

- Chemical & abrasion resistant
- Heavy-duty, reinforced zinc die-cast housing
- Spring-wrapped compression contact pins

	PART NO.	DESCRIPTION
	PHI 22-2071	15', WITH ZINC DIE-CAST PLUGS

MANY SIZES & OPTIONS AVAILABLE * Working Length - as measured by pull force J2222; length of actual cable is significantly longer

⚠ WARNING: California Proposition 65 - Cancer and Reproductive Harm - www.P65Warnings.ca.gov.



LIFTGATE CHARGING CABLES

DUAL-POLE - 2/4 GA - FINE STRANDED COPPER

- Excellent recoil memory, chemical & abrasion resistance
- Flexible from -82°F to 195°F (-63°C to 91°C)
- Internal ground to improve ground connections
- Heavy-duty, reinforced zinc die-cast housing
- Mates with dual pole metal socket 15-326

	PART NO.	DESCRIPTION
	PHI 23-2626	15', 1 GROUND, 1 HOT, 100 AMP CAPACITY

DUAL-POLE TO SINGLE POLE LEAD

- Coil has one dual pole & one single pole plug
- Excellent recoil memory, chemical & abrasion resistance
- Flexible from -82°F to 195°F (-63°C to 91°C)
- Heavy-duty, reinforced zinc die-cast housing

	PART NO.	DESCRIPTION
	PHI 23-2628	15', 1 GROUND, 1 HOT, 100 AMP CAPACITY

SINGLE POLE - 1/4 GA - FINE STRANDED COPPER

- Good recoil memory, chemical & abrasion resistance
- Flexible from -87°F to 150°F (-66°C to 66°C)
- Heavy-duty, reinforced zinc die-cast housing
- Mates with single pole metal socket 15-320

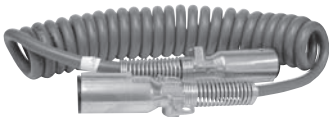
	PART NO.	DESCRIPTION
	PHI 23-4625	15', 1 HOT, 100 AMP CAPACITY

MANY SIZES & OPTIONS AVAILABLE

⚠ WARNING: California Proposition 65 - Cancer and Reproductive Harm - www.P65Warnings.ca.gov.



PLUGS

PERMAPLUG™

- Unbreakable, non-corrosive housing
- 360 ratcheting compression cable clamp
- Thread sealed screws prevent wire pull-out
- Shock absorbing insert bumper protects housing from impacts
- Spring-wrapped, machine brass compression pins

	PART NO.	DESCRIPTION
	PHI 16-730	PERMAPLUG™

ZINC DIE-CAST CONNECTOR

- Thread sealed screws prevent wire pull-out
- Shock absorbing insert bumper protects housing from impacts
- Spring-wrapped, machined brass compression pins
- Strong cable guard to support heavy cables

	PART NO.	DESCRIPTION
	PHI 15-730	HEAVY-DUTY, REINFORCED ZINC DIE-CAST PLUG WITH CABLE GUARD

ISO CONNECTOR

- Replacement plug for ISO 3731 coiled and straight cables
- Heavy-duty reinforced zinc die-cast housing for durability
- Male ground pin to prevent mis-connection
- Strong cable guard to support heavy cables
- 15-731 replacement cable guard
- 16-811 replacement insert

	PART NO.	DESCRIPTION
	PHI 15-830	ISO PLUG WITH CABLE GUARD

⚠ WARNING: California Proposition 65 - Cancer and Reproductive Harm - www.P65Warnings.ca.gov.

PHILIPS

PLUGS (continued)

7-WAY BLADE TYPE CONNECTOR

- Light-duty truck & RV connections
- Non-corrosive housing
- Use with 16-714 socket
- Large finger grips for easy coupling/uncoupling
- Brass contacts for superior conductivity

	PART NO.	DESCRIPTION	END
	PHI 16-713	7-CONDUCTOR BLADE TYPE	TRAILER END ONLY

4 & 6-WAY CONNECTORS

- Heavy-duty, reinforced zinc die-cast housing

	PART NO.	DESCRIPTION
	PHI 15-430	4-WAY PLUG W/ CABLE GUARD
	PHI 15-630	6-WAY PLUG W/ CABLE GUARD

⚠ WARNING: California Proposition 65 - Cancer and Reproductive Harm - www.P65Warnings.ca.gov.

LIFTGATE CHARGING PLUGS

SINGLE POLE - CHASSIS GROUND SYSTEM

- Universal single pole plug
- Industry-standard plug
- Lug for 4 gauge cable included
- Installs with standard lug crimp tool (crimp code gray)
- Mates with 15-320 socket

	PART NO.	DESCRIPTION
	PHI 15-335	SINGLE POLE PLUG

DUAL POLE - GROUND RETURN SYSTEM

- Provides separate power and ground connections
- Accepts 4 gauge wire only
- Separate ground pin for ground return systems
- Battery terminal crimp is required for assembly

	PART NO.	DESCRIPTION
	PHI 15-336	DUAL POLE PLUG

⚠ WARNING: California Proposition 65 - Cancer and Reproductive Harm - www.P65Warnings.ca.gov.



STA-DRY® SOCKETS

WIRE INSERTION

- Thread sealed screws prevent wire pull-out
- For protection against moisture, use socket boot P/N 15-740

	PART NO.	DESCRIPTION
	PHI 16-720	2-HOLE, WIRE INSERTION

RING & BULLET TERMINATION

- 16-722, accepts #8 ring terminals
- 16-724 and 16-725, accepts 180 bullets

	PART NO.	DESCRIPTION
	PHI 16-722	2-HOLE, RING TERMINATION

ISO SOCKET

- For ISO/auxiliary applications
- Meets ISO 3731 specifications
- Uses female ground pin
- Use #8 ring terminals

	PART NO.	DESCRIPTION
	PHI 16-822	2-HOLE, RING TERMINATION, ISO SOCKET

STRAIGHT QCS® HARNESS - REPLACEMENT SOCKET

- Significantly reduces socket replacement time
- For use with standard ABS wiring systems
- For use with most OEM configurations
- 3 o'clock, 9 o'clock and 12 o'clock positions available

	PART NO.	DESCRIPTION
	PHI 16-726	2-HOLE, BULLET WITH LOCKING CLIP FOR PHILLIPS QCS®

⚠ WARNING: California Proposition 65 - Cancer and Reproductive Harm - www.P65Warnings.ca.gov.



STA-DRY® SOCKETS (continued)

7-WAY SOCKET

- Heavy-duty, reinforced zinc die-cast housing
- Thread sealed screws prevent wire pull-out
- Elongated holes for mounting adaptability
- Stainless steel hinge pin and spring
- Full-opening lid
- Reduces exposure to contaminants & moisture, use socket boot 15-740

	PART NO.	DESCRIPTION
	PHI 15-720	2-HOLE, WIRE INSERTION SPLIT PIN

4 & 6-WAY SOCKETS

- Heavy-duty zinc die-cast housing for durability
- Elongated holes for mounting adaptability
- Stainless Steel hinge pin and spring for long-life
- Full-opening lid
- Reduce exposure to contaminants & moisture, use socket boot 15-640

	PART NO.	DESCRIPTION
	PHI 15-400	4-WAY, WIRE INSERTION, SPLIT PIN (MATES WITH 15-410 AND 15-430)
	PHI 15-600	6-WAY, WIRE INSERTION, SPLIT PIN

⚠ WARNING: California Proposition 65 - Cancer and Reproductive Harm - www.P65Warnings.ca.gov.

LIFTGATE CHARGING SOCKETS

SINGLE POLE SOCKET

- Zinc die-cast housing for durability
- Solid brass pins
- Mates with 15-335 single pole plug
- Elongated holes for mounting adaptability
- Stainless steel hinge pin and spring for long-life

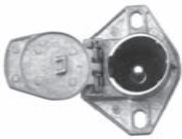
	PART NO.	DESCRIPTION
	PHI 15-320	SINGLE POLE SOCKET, FOR USE WITH 4 GAUGE, 5/16" COPPER LUG

DUAL POLE SOCKET

- Zinc die-cast housing for durability
- Solid brass pins
- Elongated holes for mounting adaptability
- Stainless steel hinge pin and spring for long life
- 1/4" stud size for lugs
- Mates with 15-336 dual pole plug

	PART NO.	DESCRIPTION
	PHI 15-326	DUAL POLE SOCKET

⚠ WARNING: California Proposition 65 - Cancer and Reproductive Harm - www.P65Warnings.ca.gov.



STA-DRY® SOCKETBREAKERS

7-WAY SOCKETBREAKERS

- Allows up to 5 ground circuits

	PART NO.	DESCRIPTION
	PHI 16-762	WITH 20 AMP CIRCUIT BREAKERS, SPLIT PINS

7-WAY EXTENDED BARREL - ZINC DIE-CAST

- Designed to support ABS cable weight
- Circuit breaker designed to be serviced in 30 seconds
- Allows up to 5 ground circuits

	PART NO.	DESCRIPTION
	PHI 15-760	WITHOUT CIRCUIT BREAKERS, SPLIT PIN
	PHI 15-762	WITH 20 AMP CIRCUIT BREAKERS, SPLIT PIN
	PHI 15-763	WITH 30 AMP CIRCUIT BREAKERS, SPLIT PIN

7-WAY ZINC DIE-CAST SOCKETBREAKER WITH NOSEBOX

- 1-7/8" deep zinc die-cast nosebox
- Fits standard mounting holes
- Includes mounting hardware for socketbreaker to nosebox

	PART NO.	DESCRIPTION
	PHI 15-7629	SOCKETBREAKER WITH 20 AMP CIRCUIT BREAKERS, SPLIT PIN

⚠ WARNING: California Proposition 65 - Cancer and Reproductive Harm - www.P65Warnings.ca.gov.





LIGHTS & ELECTRICAL ACCESSORIES

PHILIPS

ACCESSORIES

NOSEBOX KIT

- 1-7/8" deep
- For use with 15 series or 16 series socketbreakers
- Kit includes gasket, grommet and socketbreaker mounting hardware
- Does not include nosebox mounting hardware

	PART NO.	DESCRIPTION
	PHI 15-769	ZINC DIE-CAST NOSEBOX KIT
	PHI 16-775	SINGLE CAVITY NOSEBOX KIT, 3-1/2" DEEP WITH GASKET

7-WAY PLUG & SOCKET BRUSH

- Stainless steel bristles for durability
- Perfect for glove box or tool box

	PART NO.	DESCRIPTION
	PHI 4-121	7-WAY PLUG AND SOCKET BRUSH

SOCKET BOOT

	PART NO.	DESCRIPTION
	PHI 15-740	FITS PHI 15-320, PHI 15-720, PHI 15-721, PHI 15-722, PHI 16-720, PHI 16-721, PHI 16-722, PHI 16-822

⚠ WARNING: California Proposition 65 - Cancer and Reproductive Harm - www.P65Warnings.ca.gov.



CIRCUIT BREAKERS

PLUG-IN STYLE CIRCUIT BREAKERS, 12V

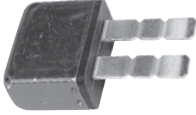
	PART NO.	AMPS	DESCRIPTION
	TWD 30409-10BX	10 AMPS	ATC/ATO BREAKERS, TYPE I CIRCUIT BREAKER SERIES
	TWD 30409-15BX	15 AMPS	
	TWD 30409-20BX	20 AMPS	
	TWD 30409-25BX	25 AMPS	
	TWD 30409-30BX	30 AMPS	

CASE STYLE CIRCUIT BREAKERS, 12V WITH STUDS

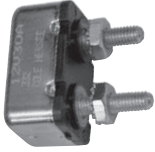
	PART NO.	AMPS	DESCRIPTION
	TWD 30056-10BX	10 AMPS	TYPE I CIRCUIT BREAKER SERIES
	TWD 30056-15BX	15 AMPS	
	TWD 30056-20BX	20 AMPS	
	TWD 30056-25BX	25 AMPS	
	TWD 30056-30BX	30 AMPS	
	TWD 30056-40BX	40 AMPS	
	TWD 30056-50BX	50 AMPS	

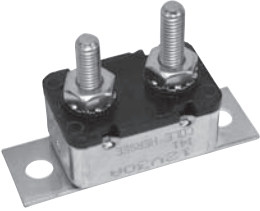
	TWD 30055-10BX	10 AMPS	TYPE I CIRCUIT BREAKER SERIES, WITH BRACKET
	TWD 30055-15BX	15 AMPS	
	TWD 30055-20BX	20 AMPS	
	TWD 30055-25BX	25 AMPS	
	TWD 30055-30BX	30 AMPS	
	TWD 30055-40BX	40 AMPS	
	TWD 30055-50BX	50 AMPS	
	TWD 30055-6BX	6 AMPS	
	TWD 30055-8BX	8 AMPS	

BLOCK WITH COMMON HOT FEED

Accepts ATC and ATO fuses and circuit breakers

	PART NO.	DESCRIPTION
	TWD 46377-6BX	6-GANG
	TWD 46377-8BX	8-GANG

⚠ WARNING: California Proposition 65 - Cancer and Reproductive Harm - www.P65Warnings.ca.gov.



LIGHTS & ELECTRICAL ACCESSORIES



Cole Hersee

CIRCUIT BREAKERS (continued)

CONNECTORS

	PART NO.	DESCRIPTION
	TWD 3032BX	FLASHER CONNECTOR ACCEPTS STANDARD 3-PRONG FLASHER UNITS

⚠ WARNING: California Proposition 65 - Cancer and Reproductive Harm - www.P65Warnings.ca.gov.



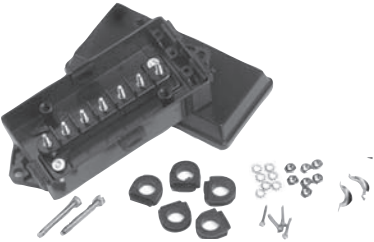

JUNCTION BOXES

	PART NO.	DESCRIPTION
	GRO 82-1000	7 TERMINAL JUNCTION BOX <ul style="list-style-type: none"> • CORROSION RESISTANT MOLDED COVER AND HOUSING • TWO-BOLT MOUNTING 7-3/8" (18.73) CENTER TO CENTER • ACCESS SLOT GROMMETS INCLUDED, FOUR OPEN-FOUR CLOSED • SEVEN #10-32 STUDS

⚠ WARNING: California Proposition 65 - Cancer and Reproductive Harm - www.P65Warnings.ca.gov.

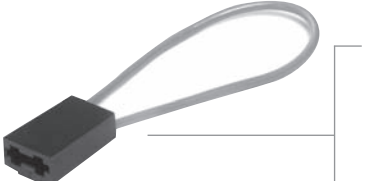
FUSE HOLDERS

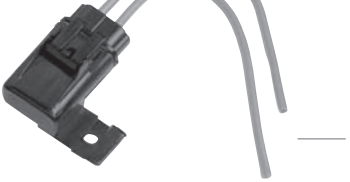
	PART NO.	DESCRIPTION
	GRO 82-2164	ATO STYLE FUSE HOLDER <ul style="list-style-type: none"> • 3-20 AMP, 14 GA 7" WIRE, BLUNT CUT • VERSATILE FUSE HOLDER FOR ATO/ATC BLADE FUSES AND PLUG-IN CIRCUIT BREAKERS
	GRO 82-2165	ATO STYLE FUSE HOLDER <ul style="list-style-type: none"> • 25-30 AMP, 12 GA 8" CONTINUOUS LOOP WIRE • VERSATILE FUSE HOLDER FOR ATO/ATC BLADE FUSES AND PLUG-IN CIRCUIT BREAKERS
	GRO 82-2166	ATO STYLE FUSE HOLDER <ul style="list-style-type: none"> • 30 AMP, 12 GA 10" WIRE • WITH PROTECTIVE CAP & MOUNTING TAB

⚠ WARNING: California Proposition 65 - Cancer and Reproductive Harm - www.P65Warnings.ca.gov.



FLASHERS		
	PART NO.	DESCRIPTION
	GRO 44530	12-LAMP ELECTROMECHANICAL FLASHER 2 TERMINAL, FLASHER
	GRO 44710	<ul style="list-style-type: none"> • 20-LAMP HEAVY DUTY ELECTRONIC FLASHER, 2 TERMINAL • 60 TO 120 FLASHES PER MINUTE • 11 TO 15-VOLTS DC • LESS THAN 3-MILLVOLTS PER AMP VOLTAGE DROP • FITS STANDARD ROUND SOCKET • EXCEEDS SAE 100-HOUR TEST
	GRO 44810	<ul style="list-style-type: none"> • 10-LAMP ELECTROMECHANICAL FLASHER, 2 TERMINAL • MOLDED BASE AND TERMINALS • HEAVY-DUTY CONTACTS • 60-120 FLASHES PER MINUTE
	GRO 44891	VARIABLE-LOAD ELECTRONIC LED FLASHER 2 TERMINAL, FLASHER

⚠ WARNING: California Proposition 65 - Cancer and Reproductive Harm - www.P65Warnings.ca.gov.

HEAVY DUTY SWITCHES		
	PART NO.	DESCRIPTION
	GRO 82-2100	PUSH/PULL SWITCH - EXTRA HEAVY DUTY, 75 AMP @ 6-12VDC - 2 POSITIONS
	GRO 82-2116	TOGGLE SWITCH - HEAVY DUTY, 75 AMP @ 6-12VDC - 2 POSITIONS
	GRO 82-2120	TOGGLE SWITCH - EXTRA HEAVY DUTY, 35 AMP @ 6-12VDC - 2 POSITIONS
	GRO 82-2125	MOMENTARY TOGGLE SWITCHES MOM ON/OFF/MOM ON
	GRO 82-2130	LED ROCKER SWITCHES ON/OFF, 25A 12V
	GRO 82-2134	LED ROCKER SWITCHES ON/OFF, 30A 12V

⚠ WARNING: California Proposition 65 - Cancer and Reproductive Harm - www.P65Warnings.ca.gov.



LIGHTS & ELECTRICAL ACCESSORIES



HEAVY DUTY ISO BASE RELAYS

- Today's trucks have as many as 40 relays
- Signal-Stat relays replace both Hella & Bosch units

	PART NO.	DESCRIPTION
	LIT 190	40A, 12V, FIVE TERMINAL, (NO TAB), SURGE PROTECTION
	LIT 191	40A, 12V, FIVE TERMINAL, (NO TAB)
	LIT 192-4	20A, 24V, FIVE TERMINAL
	LIT 192D	40A, 12V, FIVE TERMINAL
	LIT 194	40A, 12V, FOUR TERMINAL
	LIT 195	70A, 12V, FOUR TERMINAL

⚠ WARNING: California Proposition 65 - Cancer and Reproductive Harm - www.P65Warnings.ca.gov.

CONNECTORS

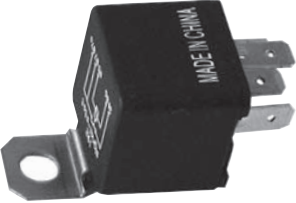
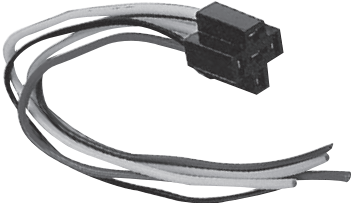
	PART NO.	DESCRIPTION
	LIT 192D	<ul style="list-style-type: none"> • FOG & DRIVING CONNECTOR • 40A, 12V, 5-TERMINAL • REPLACES BOTH HELLA AND BOSCH UNITS
	LIT 9185	<ul style="list-style-type: none"> • FOG & DRIVING RELAY CONNECTOR • WITH 12" LENGTH OF 12 GA WIRING • REPLACES BOTH HELLA AND BOSCH UNITS

⚠ WARNING: California Proposition 65 - Cancer and Reproductive Harm - www.P65Warnings.ca.gov.

ALL THESE PRODUCTS ARE AVAILABLE IN BULK.



MASTER DISCONNECT SWITCHES

SINGLE POLE

- Two positions: Off - On. For 6-36V DC systems. Will disconnect the battery circuit only.
- With diecast lever.

	PART NO.	DESCRIPTION
	TWD 2484-16BX	<ul style="list-style-type: none"> • ELECTRICAL RATINGS UL LISTED 375M: 250A AT 6V, 125A AT 12V INTERMITTENT; 40A AT 6V, 20A AT 12V CONTINUOUS • PLATED STEEL CASE, SILVER CONTACTS
	TWD 2484-ABX	<ul style="list-style-type: none"> • ELECTRICAL RATINGS 1000A INTERMITTENT, 175A CONTINUOUS; NOT UL LISTED • PLATED STEEL CASE, SILVER CONTACTS
	TWD 2484-06BX	<ul style="list-style-type: none"> • ELECTRICAL RATINGS 1000A INTERMITTENT, 175A CONTINUOUS; NOT UL LISTED • PLATED STEEL CASE, SILVER CONTACTS • WEATHER RESISTANT O-RING SEAL IN OPERATING SHAFT, GASKET-SEALED TERMINAL INSULATION AND SEALANT IN MOUNTING STEM AND CASE
	TWD 2484BX	<ul style="list-style-type: none"> • ELECTRICAL RATINGS UL LISTED 375M: 250A AT 6V, 125A AT 12V INTERMITTENT; 40A AT 6V, 20A AT 12V CONTINUOUS • PLATED STEEL CASE, COPPER CONTACTS
	TWD M-284BX	<ul style="list-style-type: none"> • ELECTRICAL RATINGS 1000A INTERMITTENT, 175A CONTINUOUS, NOT UL LISTED • BRASS CASE, COPPER CONTACTS, LONG STEM
	TWD 75908BX	<ul style="list-style-type: none"> • 2000A INTERMITTENT, WEATHER-RESISTANT • 30 SECONDS ON, 3 MINUTES OFF, 300A CONTINUOUS • PLATED STEEL CASE

SINGLE POLE, HIGH AMPERAGE CAPACITY

	PART NO.	DESCRIPTION
	TWD 75920BX	<ul style="list-style-type: none"> • 300A AT 12V DC • PROTECTS VEHICLES AGAINST TAMPERING, THEFT AND BATTERY DRAIN • CAN BE USED IN BOTH POSITIVE OR IN NEGATIVE PATH APPLICATIONS • WATERPROOF AND DUSTPROOF TO IP67IP (IMMERSIBLE)

⚠ WARNING: California Proposition 65 - Cancer and Reproductive Harm - www.P65Warnings.ca.gov.

LIGHTS & ELECTRICAL ACCESSORIES





Cole Hersee

ALL THESE PRODUCTS ARE AVAILABLE IN BULK.

MASTER DISCONNECT SWITCHES (continued)

DOUBLE POLE

- Two positions: Off - On. For 6-36V DC systems. Will disconnect the battery and the alternator or generator field circuit.
- With diecast lever.

	PART NO.	DESCRIPTION
	TWD 75903BX	<ul style="list-style-type: none"> • STEEL CASE • ELECTRICAL RATINGS: LARGE STUDS: 1000A INTERMITTENT, 15 SECONDS ON, 5 MINUTES OFF, 125A CONTINUOUS (UNLESS NOTED), SMALL STUDS: 20A CONTINUOUS • CHROME-PLATED DIECAST LEVER, BRASS CONTACTS
	TWD 75904-01BX	<ul style="list-style-type: none"> • WEATHER-RESISTANT, WITH INDEXING PIN AND O-RING • ELECTRICAL RATINGS: LARGE STUDS: 1000A INTERMITTENT 15 SECONDS ON, 5 MINUTES OFF, 125A CONTINUOUS (UNLESS NOTED), SMALL STUDS: 20A CONTINUOUS • PLATED STEEL CASE, SILVER-LAMINATED CONTACTS
	TWD 75907BX	<ul style="list-style-type: none"> • 2000A INTERMITTENT, WEATHER-RESISTANT • ELECTRICAL RATINGS: LARGE STUDS: 2000A INTERMITTENT, 30 SECONDS ON, 3 MINUTES OFF, 300A CONTINUOUS, SMALL STUDS: 20A CONTINUOUS • PLATED STEEL CASE, CHROME-PLATED DIECAST LEVER

ACCESSORIES

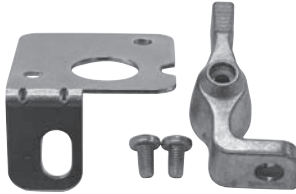
	PART NO.	DESCRIPTION
	TWD 24505BX	<ul style="list-style-type: none"> • LOCKOUT LEVER KIT • SPECIAL LEVER AND FLANGE PLATE ACCEPT A PADLOCK TO SECURELY LOCK A DISCONNECT SWITCH IN THE OFF POSITION, WHICH IS REQUIRED BY MANY LOCK-OUT/TAG-OUT SAFETY REGULATIONS

⚠ WARNING: California Proposition 65 - Cancer and Reproductive Harm - www.P65Warnings.ca.gov.

LIGHTS & ELECTRICAL ACCESSORIES

ALL THESE PRODUCTS ARE AVAILABLE IN BULK.



TOGGLE SWITCHES

HEAVY DUTY, 25A

Standard handle. Universal application. Silver contacts.

SPST		
	PART NO.	DESCRIPTION
	TWD 55014BX	<ul style="list-style-type: none"> • UP: ON, DOWN: OFF • TWO BLADE TERMINALS
	TWD 5582BX	<ul style="list-style-type: none"> • UP: ON, DOWN: OFF • TWO SCREW TERMINALS
	TWD 5582-10BX	<ul style="list-style-type: none"> • UP: ON, DOWN: OFF • TWO 8" (203.2 MM) LEADS, O-RING SEAL, PVC COATED
SPDT		
	PART NO.	DESCRIPTION
	TWD 5584BX	<ul style="list-style-type: none"> • UP: ON, DOWN: ON • THREE SCREW TERMINALS
	TWD 5586BX	<ul style="list-style-type: none"> • UP: ON, CENTER: OFF, DOWN: ON • THREE SCREW TERMINALS
SPDT MOMENTARY		
	PART NO.	DESCRIPTION
	TWD 55021BX	<ul style="list-style-type: none"> • UP: MOM ON, CENTER: OFF, DOWN: MOM ON • THREE SCREW TERMINALS
	TWD 55021-07BX	<ul style="list-style-type: none"> • UP: MOM ON, CENTER: OFF, DOWN: MOM ON • PVC COATED HOUSING WITH THREE 8" (203.2 MM) LEADS. O-RING SEAL IN THE STEM.



LIGHTS & ELECTRICAL ACCESSORIES

⚠ WARNING: California Proposition 65 - Cancer and Reproductive Harm - www.P65Warnings.ca.gov.



Cole Hersee

ALL THESE PRODUCTS ARE AVAILABLE IN BULK.

TOGGLE SWITCHES (continued)

HEAVY DUTY, 25A (continued)

DPDT

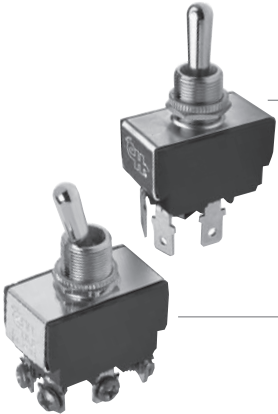
	PART NO.	DESCRIPTION
	TWD 55046BX	<ul style="list-style-type: none"> • UP: MOM ON, CENTER: OFF, DOWN: MOM ON • FOUR BLADE TERMINALS
	TWD 5592BX	<ul style="list-style-type: none"> • UP: ON, CENTER: OFF, DOWN: ON • SIX SCREW TERMINALS

DPDT MOMENTARY

	PART NO.	DESCRIPTION
	TWD 55054BX	<ul style="list-style-type: none"> • UP: MOM ON, CENTER: OFF, DOWN: MOM ON • SIX SCREW TERMINALS

ACCESSORIES

	PART NO.	DESCRIPTION
	TWD 81264BX	<ul style="list-style-type: none"> • TOGGLE BOOT SEAL - GRAY • DURABLE SILICONE RUBBER BONDED TO A STANDARD 15/32" - 32 THREAD NICKEL PLATED BRASS HEXNUT
	TWD 81255BX	<ul style="list-style-type: none"> • HALF-BOOT SEAL • ALLOWS ANY LENGTH OF HANDLE TO PROTRUDE, YET SEALS TIGHTLY TO HANDLE

⚠ WARNING: California Proposition 65 - Cancer and Reproductive Harm - www.P65Warnings.ca.gov.

LIGHTS & ELECTRICAL ACCESSORIES

ALL THESE PRODUCTS ARE AVAILABLE IN BULK.



WEATHER-RESISTANT ROCKER SWITCHES

SPST ON-OFF, DEPENDENT

- Single pole, single throw, with dependent illumination
- Three blade terminals
- 25A at 12V DC, incandescent

	PART NO.	DESCRIPTION
	TWD 58328-04BX	RED LENS
	TWD 58328-11BX	GREEN LENS

⚠ WARNING: California Proposition 65 - Cancer and Reproductive Harm - www.P65Warnings.ca.gov.

MOMENTARY SWITCHES

NORMALLY OFF PUSH-BUTTON SWITCHES

For applications to 36V DC

	PART NO.	DESCRIPTION
	TWD 9245BX	<ul style="list-style-type: none"> • WITH SEAL AND SNAP-ON CAP • TWO SCREW TERMINALS, SILVER CONTACTS • O-RING SEAL IN THE MOUNTING STEM, SNAP-ON BLACK RUBBER PROTECTIVE CAP (407-03), AND BLACK PLASTIC BUTTON
	TWD 90030BX	<ul style="list-style-type: none"> • WITH PLASTIC BUTTON, AND SCREW-ON CAP • TWO SCREW TERMINALS • WITH SCREW-ON BLACK RUBBER PROTECTIVE CAP (83280-03)

⚠ WARNING: California Proposition 65 - Cancer and Reproductive Harm - www.P65Warnings.ca.gov.

SOLENOIDS

CONTINUOUS DUTY

85A except where noted, normally open contacts, SPST, one circuit: Off - On

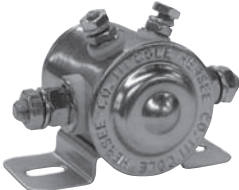
	PART NO.	DESCRIPTION
	TWD 24063BX	24V INSULATED, PLATED STEEL HOUSING
	TWD 24214BX	<ul style="list-style-type: none"> • 24V INSULATED, ELECTRICAL RATING: 200A CARRY ONLY • NOT TO BREAK 200A AT 24V DC, SILVER TUNGSTEN CARBIDE CONTACTS

⚠ WARNING: California Proposition 65 - Cancer and Reproductive Harm - www.P65Warnings.ca.gov.



ALL THESE PRODUCTS ARE AVAILABLE IN BULK.

SOLENOIDS (continued)

CONTINUOUS DUTY (continued)

	PART NO.	DESCRIPTION
	TWD 24059BX	12V INSULATED
	TWD 24106BX	12V GROUNDED
	TWD 24213BX	12V INSULATED, ELECTRICAL RATING: 200A, SILVER TUNGSTEN CARBIDE CONTACTS
	TWD 24082BX	12V GROUNDED, CURVED BRACKET

INTERMITTENT DUTY

Normally Off, SPST, One circuit: Off - On

	PART NO.	DESCRIPTION
	TWD 24008BX	24V INSULATED
	TWD 24037BX	12V GROUNDED
	TWD 24047BX	12V INSULATED

MOTOR REVERSING, INTERMITTENT DUTY

	PART NO.	DESCRIPTION
	TWD 24450BX	MOTOR REVERSING SOLENOID, DPDT INTERMITTENT DUTY, 12V DC

⚠ WARNING: California Proposition 65 - Cancer and Reproductive Harm - www.P65Warnings.ca.gov.

LIGHTS & ELECTRICAL ACCESSORIES

ALL THESE PRODUCTS ARE AVAILABLE IN BULK.



WARNING DEVICES

	PART NO.	DESCRIPTION
	TWD 4099BX	UNIVERSAL BUZZER 12V DC • HUNDREDS OF USES. • FOR "DOOR AJAR" WARNING, BUS DRIVER ALERT, LOW AIR PRESSURE, TEMPERATURE, ETC. • WORKS WITH ANY TEMPERATURE, PRESSURE, DOOR OR MOMENTARY SWITCH

⚠ WARNING: California Proposition 65 - Cancer and Reproductive Harm - www.P65Warnings.ca.gov.

HEAVY-DUTY PILOT LIGHTS

PL-20 SERIES WITH EXTRA WIRE FOR GROUND

	PART NO.	DESCRIPTION
	TWD PL-20-AC	AMBER LENS
	TWD PL-20-GC	GREEN LENS
	TWD PL-20-RC	RED LENS

PL-19 SERIES WITH CHROME BEZEL

	PART NO.	DESCRIPTION
	TWD PL-19-AC	AMBER LENS
	TWD PL-19-GC	GREEN LENS
	TWD PL-19-RC	RED LENS

PL-2 SERIES WITH SMALL 3/16" LENS

	PART NO.	DESCRIPTION
	TWD PL-2-AC	AMBER LENS
	TWD PL-2-GC	GREEN LENS
	TWD PL-2-RC	RED LENS

⚠ WARNING: California Proposition 65 - Cancer and Reproductive Harm - www.P65Warnings.ca.gov.





J

UNDER THE HOOD

BATTERIES.....	296-297
WIRES & CABLES.....	298-301
BATTERY ACCESSORIES.....	301-302
ALTERNATORS & STARTERS.....	303-309
WATER PUMPS.....	310-311
OIL FILLER CAPS & DIPSTICKS.....	312
RADIATOR COMPONENTS & THERMOSTATS.....	313
COOLANT RESERVOIRS & COMPONENTS.....	314
WINDSHIELD WASHER RESERVOIRS.....	315
HOSES, BELTS & ACCESSORIES.....	315-317



TRUCKS & BUSES (GROUP 31) - 6 VOLT

- Anchor-locked elements resist vibration damage for added dependability, extended life. Tough reinforced polypropylene cases withstand heavy commercial service. Deep pocket envelope separators protect all sides of the plate to prevent shorts, ensuring top performance

	BCI Group	Part No.	Min. Cranking Amps (CCA) @ 32 F	Cold Cranking Amps (Cca) @ 0 F	Min. Reserve Capacity @ 80 F	Length (In)	Width (In)	Height (In)
	1	BAT 7244	800	640	130	9	6-7/8	8-3/4
	2	BAT 7204	840	675	185	10-3/8	6-7/8	8-3/4
	3EH	BAT 7248	1035	875	250	19-1/4	4-1/4	10
	4	BAT 7212, BAT 7264D	1190	975	250	12-1/2	6-7/8	9-1/2
	5D	BAT 7263	1100	880	250	13-3/8	7-1/8	9-1/4

HEAVY DUTY COMMERCIAL & FARM EQUIPMENT-12 VOLT

- Extra heavy-duty batteries deliver more cranking amps per pound. Quality workmanship and computer-aided manufacturing provides the latest in dependable power and advanced durability. Batteries feature anchor-locked elements, deep pocket envelope separators, and reinforced polypropylene cases.

	BCI Group	Part No.	Min. Cranking Amps (CCA) @ 32 F	Cold Cranking Amps (Cca) @ 0 F	Min. Reserve Capacity @ 80 F	Length (In)	Width (In)	Height (In)
	4D	BAT 7266	1280	1050	290	20-3/4	8-1/2	10-1/8
	8D	BAT 7271FT	1730	1425	440	20-3/4	11	10
	8D	BAT 7271	1700	1400	430	20-3/4	11	10
	8D	BAT 7269	1340	1100	325	20-3/4	11	10
	30H	BAT 7218	800	650	150	13	6-3/4	9-1/2

AGM TECHNOLOGY

- AGM design provides superior starting and reserve power for multiple accessories, electronic loads, and emergency needs. Tough reinforced polypropylene cases and maintenance-free construction without the need to add water. Requires less charging time than conventional batteries.

	BCI Group	Part No.	Min. Cranking Amps (CCA) @ 32 F	Cold Cranking Amps (Cca) @ 0 F	Res. Cap.	Length (In)	Width (In)	Height (In)
	4D	BAT 9273	1110	-	380	20-3/4	8-1/2	10
	8D	BAT 9275	1450	-	480	20-3/4	11	10

⚠ WARNING: Battery posts, terminals and related accessories contain lead and lead compounds, chemicals known to the State of California to cause cancer and reproductive harm. Batteries also contain other chemicals known to the State of California to cause cancer. WASH HANDS AFTER HANDLING.

UNDER THE HOOD

J



NAPA COMMERCIAL BATTERIES



- Constructed using calcium, maintenance-free lead alloy plates. Oversized straps reduce resistance for maximum cold cranking amps. Anchor-locked elements resist vibration damage for dependable use and extended life.

	Part No.	Type		V	CCA	CA	RC	Length	Width	Height	Approx. Weight
	BAT 7231	Commercial	Wet	12	650	800	150	13	6-3/4	9-1/2	52
	BAT 7234	Commercial	Wet	12	1125	1380	195	13	6-3/4	9-1/2	63.5
	BAT 7236	Commercial	Wet	12	950	1170	175	13	6-3/4	9-1/2	56.5
	BAT 7238	Commercial	Wet	12	760	935	170	13	6-3/4	9-1/2	53.5

⚠ WARNING: Battery posts, terminals and related accessories contain lead and lead compounds, chemicals known to the State of California to cause cancer and reproductive harm. Batteries also contain other chemicals known to the State of California to cause cancer. WASH HANDS AFTER HANDLING.

NAPA COMMERCIAL AGM BATTERIES

- Feature Dual SAE Posts & Stainless Steel Studs to fit more commercial applications. Over-the-top handles provide easy installations, fold out of the way after installation.

	Part No.	Type		V	CCA	CA	RC	Length	Width	Height	Approx. Weight
	BAT 9833	Commercial AGM	Glass Mat	12	800	1000	200	13	6-3/4	9-1/2	67.5
	BAT 9835	Commercial AGM	Glass Mat	12	925	1050	190	13	6-3/4	9-1/2	66.5
	BAT 9831DT	Commercial AGM	Glass Mat	12	800	1000	200	12-7/8	6-3/4	9-3/8	67.5

⚠ WARNING: Battery posts, terminals and related accessories contain lead and lead compounds, chemicals known to the State of California to cause cancer and reproductive harm. Batteries also contain other chemicals known to the State of California to cause cancer. WASH HANDS AFTER HANDLING.

UNDER THE HOOD



Belden
BATTERY CABLE
Type SGR

- 100% Copper Cable
- Meets all SAE code J1127 specifications
- All Battery Cable is spooled
- Chlorinated Polyethylene (CPE) jacket rated at -40°C (-40°F) to 90°C (194°F)
- 1000' + custom size spools available upon request



PART NO.	GAUGE	OUTSIDE DIAMETER
25' SPOOLS (7.6 M), BLACK		
BEL 736102	4	.365"
BEL 736104	2	.490"
BEL 736106	1	.490"
BEL 736150	1/0	.535"
BEL 736152	2/0	.575"
BEL 736154	3/0	.670"
BEL 736156	4/0	.788"
50' SPOOLS (15.2 M), BLACK		
BEL 736164	4	.365"
BEL 736163	2	.490"
BEL 736162	1	.490"
BEL 736161	1/0	.535"
BEL 736153	2/0	.575"
BEL 736155	3/0	.670"
100' SPOOLS (30.5 M), BLACK		
BEL 736103	4	.365"
BEL 736105	2	.490"
BEL 736107	1	.490"
BEL 736151	1/0	.535"
BEL 736157	2/0	.575"

WARNING: California Proposition 65 - Cancer and Reproductive Harm - www.P65Warnings.ca.gov.

PHILIPS**BULK TRAILER CABLES – LECTRAFLEX™****7 CONDUCTOR - 1/8, 2/10, 4/12 GA (.700 O.D.)**

- For ABS applications
- Superior abrasion resistance
- Meets SAE J2394 specifications
- Green jacket
- Stays flexible to -40°F (-40°C)



	PART NO.	LENGTH	STRANDING 12 GA	STRANDING 10 GA	STRANDING 8 GA
	PHI 3-327	100'	65 X 30	105 X 30	168 X 30
	PHI 3-328	250'	65 X 30	105 X 30	168 X 30
	PHI 3-329	500'	65 X 30	105 X 30	168 X 30

⚠ WARNING: California Proposition 65 - Cancer and Reproductive Harm - www.P65Warnings.ca.gov.

BULK TRAILER CABLES – ARCTIC SUPERFLEX

- Designed for durability in extreme temperatures
- Stays flexible from -85°F to 175°F (-65°C to 79°C)
- Resistant to chemicals, oils & fuels
- Dark blue jacket color

**7 CONDUCTOR - 1/10, 6/12 GA (.640 O.D.)**

Black - Brown - Blue - Green - Red - White - Yellow

PART NO.	LENGTH	STRANDING 12 GA	STRANDING 10 GA
PHI 3-632	100'	65 X 30	105 X 30
PHI 3-633	250'	65 X 30	105 X 30

7 CONDUCTOR - 6/14, 1/2 GA (.570 O.D.)

Black - Brown - Blue - Green - Red - White - Yellow

PART NO.	LENGTH	STRANDING 14 GA	STRANDING 12 GA
PHI 3-622	100'	41 X 30	65 X 30
PHI 3-623	250'	41 X 30	65 X 30
PHI 3-624	500'	41 X 30	65 X 30

6 CONDUCTOR - 6/14 GA (.550 O.D.)

Black - Brown - Green - Red - White - Yellow

PART NO.	LENGTH	STRANDING
PHI 3-613	250'	41 X 30

⚠ WARNING: California Proposition 65 - Cancer and Reproductive Harm - www.P65Warnings.ca.gov.

PHILIPS

BULK TRAILER CABLES – ARCTIC SUPERFLEX (continued)

4 CONDUCTOR – 4/14 GA (.440 O.D.)

Brown - Yellow - Green - White

PART NO.	LENGTH	STRANDING
PHI 3-602	100'	41 X 30
PHI 3-603	250'	41 X 30

3 CONDUCTOR – 3/14 GA (.440 O.D.)

Black - Red - White

PART NO.	LENGTH	STRANDING
PHI 3-663	250'	41 X 30

2 CONDUCTOR – 2/14 GA (.340 O.D.)

Black - White

PART NO.	LENGTH	STRANDING
PHI 3-653	250'	41 X 30
PHI 3-654	500'	41 X 30

⚠ WARNING: California Proposition 65 - Cancer and Reproductive Harm - www.P65Warnings.ca.gov.

BULK TRAILER CABLES – DURAFLEX™

- For general trailer re-wiring
- Black jacket
- Stays flexible to -40°F (-40°C)
- Meets SAE J1128 specifications



7 CONDUCTOR – 1/10, 6/12 GA (.570 O.D.)

Black - Brown - Blue - Green - Red - White - Yellow

PART NO.	LENGTH
PHI 3-222	100'
PHI 3-224	500'

7 CONDUCTOR – 1/12, 6/14 GA (.500 O.D.)

Black - Brown - Blue - Green - Red - White - Yellow

PART NO.	LENGTH
PHI 3-242	100'
PHI 3-243	250'
PHI 3-244	500'

⚠ WARNING: California Proposition 65 - Cancer and Reproductive Harm - www.P65Warnings.ca.gov.



BULK TRAILER CABLES – DURAFLEX™ (continued)

4 CONDUCTOR - 4/14 GA (.400 O.D.)

Brown - Yellow - Green - White

PART NO.	LENGTH
PHI 3-192	100'
PHI 3-194	500'

⚠ WARNING: California Proposition 65 - Cancer and Reproductive Harm - www.P65Warnings.ca.gov.

BATTERY CABLE

- Rope-style stranding for flexibility
- Easy to strip
- Superior abrasion resistance
- Operating temperature range -40°F to 150°F (-40°C to 66°C)
- Multiple sizes available, please contact your Traction representative for details



PART NO.	SIZE	LENGTH	STRANDING	COLOR
PHI 3-511	2/0 GA	25'	259 X 23	RED
PHI 3-511-250	2/0 GA	250'	259 X 23	RED
PHI 3-512	2/0 GA	25'	259 X 23	BLACK
PHI 3-512-250	2/0 GA	250'	259 X 23	BLACK

⚠ WARNING: California Proposition 65 - Cancer and Reproductive Harm - www.P65Warnings.ca.gov.



Wire Products

BATTERY TERMINALS

COPPER LUGS

- Seamless 100% copper tube construction
- Can be crimped or soldered
- Ideal for most general purpose applications



PART NO.	GAUGE	STUD OR TAB SIZE	PACK	PART NO.	GAUGE	STUD OR TAB SIZE	PACK
NW 728033	8	# 10	25	NW 728038	1	1/2"	25
NW 728552	8	3/8"	10	NW 728037	1	3/8"	25
NW 728554	6	1/4"	10	NW 728104	1	1/2"	5
NW 728034	6	# 10	25	NW 728039	1/0	3/8"	25
NW 728101	6	3/8"	5	NW 728105	1/0	1/2"	5
NW 785905	6	3/8"	2	NW 728060	2/0	3/8"	10
NW 728005	4	1/4"	5	NW 728040	2/0	1/2"	10
NW 728035	4	3/8"	25	NW 728555	3/0	3/8"	10
NW 728103	2	1/2"	5	NW 728107	4/0	3/8"	5
NW 728036	2	3/8"	25	NW 728106	4/0	1/2"	5

⚠ WARNING: California Proposition 65 - Cancer and Reproductive Harm - www.P65Warnings.ca.gov.

UNDER THE HOOD





NAPA Wire Products

UNDER THE HOOD

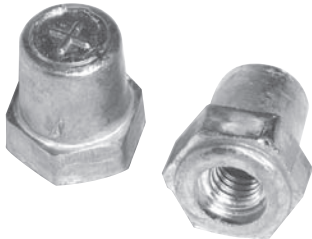

BATTERY HARDWARE

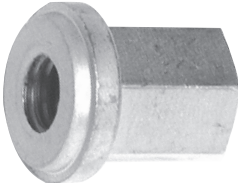
	PART NO.	DESCRIPTION
	NW 728199	HEAVY DUTY CONVERSION CONNECTORS - STUD-TO-TOP POST • CONVERTS STUD TERMINAL BATTERY TO A TOP POST • POLARITY SPECIFIC FOR EXACT FIT • LEAD; DIE CAST STEEL • 3/8" - 16 THREADED STEEL INSERT AND NYLON LOCK RING PROVIDE SUPERIOR ELECTRICAL CONDUCTIVITY • 3/4" HEX BASE PERMITS PRECISE TORQUING STYLE: POSITIVE/NEGATIVE
	NW 728302	HEAVY DUTY UNIVERSAL CLAMPS, BULK PACK • DESIGNED FOR TRUCK, BUS, CONSTRUCTION, AGRICULTURE AND INDUSTRIAL APPLICATIONS • POLARITY SPECIFIC BRASS OR UNIVERSAL POLARITY LEAD CONSTRUCTION • HARDWARE INCLUDED • ACCEPT 1 GA THROUGH 3/0 GA CABLES LEAD; ZINC PLATED
	NW 728006	NUT, CLOSED CAP FOR GROUP 31, BULK PACK • STAINLESS STEEL • 3/8-16 THREADS • MEETS OEM AND SAE SPECIFICATIONS

⚠ WARNING: California Proposition 65 - Cancer and Reproductive Harm - www.P65Warnings.ca.gov.

NAPA BALKAMP

BOOSTER CABLES

- Industrial grade; cable construction of 100% fine stranded copper wire
- Red & black; pack size: 1
- Tangle-free design remains flexible even in cold climate







PART NO.	GAUGE	FEATURES	LENGTH	STYLE
BK 782-5252	4 GAUGE	500 AMP	20'	PARROT JAW
BK 782-5251	2 GAUGE	600 AMP	25'	STANDARD JAW
BK 782-5259	4 GAUGE	600 AMP	25'	STANDARD JAW

⚠ WARNING: California Proposition 65 - Cancer and Reproductive Harm - www.P65Warnings.ca.gov.



REMAN & NEW ALTERNATORS

	PART NO.	DESCRIPTION	REPLACEMENT OPTIONS
21SI			
	TWD 10459013	REMAN, J180 HINGE MOUNT - 12V, 100A	19020310
	TWD 10459037	REMAN, J180 HINGE MOUNT - 12V, 130A	19020310
22SI			
	TWD 19020310	NEW, J180 HINGE MOUNT - 12V, 150A	19020310
	TWD 19020889	NEW, PAD MOUNT - 12V, 150A	19020889
	TWD 10459320	REMAN, PAD MOUNT - 12V, 130A	19020889
24SI			
	TWD 8700008	REMAN, PAD MOUNT - 12V, 145A	-
	TWD 8600889	NEW, PAD MOUNT - 12V, 160A	8600889
26SI			
	TWD 10459076	REMAN, J180 HINGE MOUNT - 24V, 75A	-
28SI			
	TWD 8600314	NEW, PAD MOUNT - 12V, 200A	8600314
30SI			
	TWD 10459008	REMAN, J180 HINGE MOUNT - 105A, 12V	-
35SI			
	TWD 8600066	REMAN, PAD MOUNT - 12V, 140A	8600127
	TWD 8700018	REMAN, PAD MOUNT - 12V, 140A	8600127









UNDER THE HOOD



⚠ WARNING: California Proposition 65 - Cancer and Reproductive Harm - www.P65Warnings.ca.gov.



ALTERNATORS





	PART NO.	VOLTAGE	AMPERAGE	SERIES	O.E. MANUF.
	WIL 90014072	12V	145A	21SI	DELCO REMY
	WIL 90014074	12V	130A	21SI	DELCO REMY
	WIL 90014152	24V	70A	21SI	DELCO REMY
	WIL 90014262	12V	135A	33SI	DELCO REMY
	WIL 90014270	12V	145A	22SI	DELCO REMY
	WIL 90014334	24V	70A	21SI	DELCO REMY
	WIL 90014393	12V	145A	22SI	DELCO REMY
	WIL 90015504	24V	270A	50DN	DELCO REMY
	WIL 90025065	12V	130A	3G	FORD
	WIL 90047021	12V	130A	2600, 2700	PRESTOLITE (LEECE NEVILLE)
	WIL 90059249	12V	140A	BLP	PRESTOLITE (MOTOROLA)
	WIL 90059251	12V	160A	BLP	PRESTOLITE (MOTOROLA)
	WIL 90156392	24V	140A	T1	BOSCH

UNDER THE HOOD





⚠ WARNING: California Proposition 65 - Cancer and Reproductive Harm - www.P65Warnings.ca.gov.



ALTERNATORS (continued)		
	PART NO.	DESCRIPTION
	TWD 110555JHO	J-180 MOUNT, 12V, 160A
	TWD 110555PHO	PAD MOUNT, 12V, 160A
	TWD 110444	J-180 MOUNT, 12V, 150A
	TWD 2800LC	J-180 MOUNT, 12V, 160A
	TWD AVI555P	AVI ALTERNATOR, PAD MOUNT, 12V, 170A

⚠ WARNING: California Proposition 65 - Cancer and Reproductive Harm - www.P65Warnings.ca.gov.



ALTERNATORS (continued)		
	PART NO.	DESCRIPTION
22 SERIES		
	TWD ALT1003	12V, 150A, PAD MOUNT
	TWD ALT1004	12V, 150A, STD. J180 MOUNT (WITH 1/4" BATTERY POST)
24 SERIES		
	TWD ALT1240	12V, 160A, PAD MOUNT (DELCO 24SI)







⚠ WARNING: California Proposition 65 - Cancer and Reproductive Harm - www.P65Warnings.ca.gov.

UNDER THE HOOD



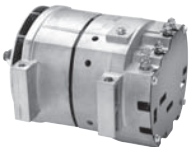

ALTERNATORS (continued)

	PART NO.	DESCRIPTION
22 SERIES		
	TWD ALT1003	12V, 150A, PAD MOUNT
	TWD ALT1004	12V, 150A, STD. J180 MOUNT (WITH 1/4" BATTERY POST)
24 SERIES		
	TWD ALT1240	12V, 160A, PAD MOUNT (DELCO 24SI)
28 SERIES		
	TWD ALT1280	12V, 200A, STD. PAD MOUNT
	TWD ALT1281	12V, 200A, STD. J180 MOUNT (DELCO 28SI)
	TWD ALT1282	12V, 200A, STD. J180 LEECE-NEVILLE MOUNT (DELCO 28SI)
33 SERIES		
	TWD ALT3632	12V, 135A, J180 MOUNT
35 SERIES		
	TWD ALT3650	12V, 140A, PAD MOUNT
36 SERIES		
	PART NO.	DESCRIPTION
	TWD ALT3600	12V, 170A, PAD MOUNT

⚠ WARNING: California Proposition 65 - Cancer and Reproductive Harm - www.P65Warnings.ca.gov.



ALTERNATORS (continued)

110 SERIES

	PART NO.	DESCRIPTION
	TWD ALT0050	12V, 160A, STD. J180 MOUNT
	TWD ALT0060	12V, 165A, STD. J180 MOUNT
	TWD ALT0061	12V, 165A, PAD MOUNT

HIGH AMP

	PART NO.	DESCRIPTION
	TWD ALT0270	12V, 275A, HINGE MOUNT

⚠ WARNING: California Proposition 65 - Cancer and Reproductive Harm - www.P65Warnings.ca.gov.

STARTERS

28 SERIES

	PART NO.	DESCRIPTION
	TWD STR7051	12V, 2.5KW, 10 TEETH
	TWD STR0120	12V, 4.6KW, 10 TEETH
	TWD STR0123	12V, 4.6KW, 11 TEETH

⚠ WARNING: California Proposition 65 - Cancer and Reproductive Harm - www.P65Warnings.ca.gov.

UNDER THE HOOD





STARTERS (continued)

39 SERIES

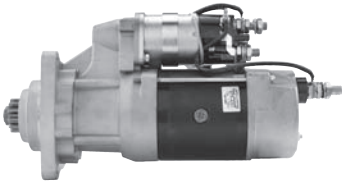
	PART NO.	DESCRIPTION
	TWD STR4292	12V, 11 TEETH
	TWD STR4295	12V, 12 TEETH

42 SERIES

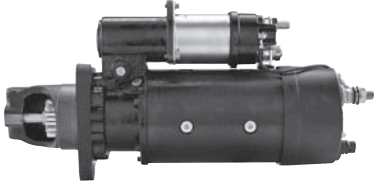

	PART NO.	DESCRIPTION
	TWD STR4200	12V, 11 TEETH
	TWD STR4201	12V, 11 TEETH
	TWD STR4202	12V, 12 TEETH
	TWD STR4207	12V, 11 TEETH
	TWD STR4208	12V, 11 TEETH
	TWD STR4302	24V, 11 TEETH
	TWD STR4303	24V, 12 TEETH

⚠ WARNING: California Proposition 65 - Cancer and Reproductive Harm - www.P65Warnings.ca.gov.

UNDER THE HOOD



STARTERS (continued)

	PART NO.	VOLTAGE	SERIES	NO. OF TEETH
	WIL 91013700	24V	40MT	11
	WIL 91013701	12V	40MT	11
	WIL 91013703	24V	40MT	12
	WIL 91013948	24V	50MT	11
	WIL 91014107	12V	50MT	11
	WIL 91014159	24V	42MT	11
	WIL 91014161	12V	42MT	12
	WIL 91014166	12V	42MT	11
	WIL 91014296	12V	42MT	11

⚠ WARNING: California Proposition 65 - Cancer and Reproductive Harm - www.P65Warnings.ca.gov.



STARTERS (continued)				
	PART NO.	VOLTAGE	SERIES	NO. OF TEETH
	WIL 91014307	12V	37MT	10
	WIL 91014396	12V	37MT	12
	WIL 91157143	12V	DW	9
	WIL 91295550	12V	P5.0	12

⚠ WARNING: Cancer and Reproductive Harm



UNDER THE HOOD

STARTERS (continued)		
REMAN & NEW STARTERS		
	PART NO.	DESCRIPTION
37MT		
	TWD 10461169	REMAN - 12V
	TWD 10461098	REMAN - 12V
39MT		
	TWD 8200289	NEW - 12V
42MT		
	TWD 10461052	REMAN - 12V
	TWD 10461053	REMAN - 12V
	TWD 10461055	REMAN - 12V
	TWD 10461075	REMAN - 12V

⚠ WARNING: California Proposition 65 - Cancer and Reproductive Harm - www.P65Warnings.ca.gov.

J



HEAVY-DUTY WATER PUMPS

37 SKUs For Virtually Any Heavy-Duty/Fleet Application.



UNDER THE HOOD

Part No.	Engine
CATERPILLAR	
TFW 43233HD	Caterpillar 3208
TFW 43554HD	Caterpillar 3116/3126 - 4.37" Pulley
TFW 45009HD	Caterpillar 3406B&C
TFW 44054HD	Caterpillar 3406E, BDITA, C15
TFW 44600HDBP	Caterpillar Back Plate 3406 B/C
CUMMINS	
TFW 43320HD	Cummins C series, 8.3 liter Long Nose
TFW 43321HD	Cummins C series, 8.3 liter Long Nose Hardened Pulley
TFW 44094HD	Cummins Diesel L10
TFW 43307HD	Cummins Diesel L10, M11, ISM
TFW 44084HD	Cummins Diesel 14.0L, 6Cyl
TFW 44086HD	Cummins Diesel 14.0L, 6Cyl
TFW 44064HD	Cummins Diesel 14.0L, NT 6Cyl
TFW 44092HD	Cummins Diesel Big Cam VI 14.0L, 6Cyl

Part No.	Engine
CUMMINS (continued)	
TFW 42352HD	Cummins Diesel C Series 8.3L, C160,175,180,CF160
TFW 45051HD	Cummins Diesel ISX 4089908 10 Rib Pulley
TFW 45054HD	Cummins Diesel ISX 4089910 12 Rib Pulley
TFW 44052HD	Cummins Diesel N14 14.0L
TFW 41111HD	Cummins Diesel Idler 14.0L
TFW 42146HD	Cummins ISC & ISL 8.3L
DETROIT DIESEL	
TFW 46003HD	DETROIT DIESEL 12L EGR 60 SERIES
TFW 46004HD	Detroit Diesel 14L EGR 60 Series
TFW 43309HD	Detroit Diesel 53 Series, Left hand
TFW 44066HD	Detroit Diesel 6 Cyl, 11.1L, 12.7L, 60 Series, 50-55 Series
TFW 46002HD	Detroit Diesel 60 Series Pocket Pump
TFW 46001HD	Detroit Diesel V8 8.2L
FORD	
TFW 43042HD	Ford Tractor & Industrial 3CYL 158,175, 4CYL,233, 256
TFW 43021HD	Ford Truck 6CYL, 6.6L 7.8L
TFW 43125HD	Ford Truck 6CYL, 6.6L 7.8L
INTERNATIONAL	
TFW 42114HD	International 9.0 Liter Engine, 1976-83
TFW 43545HD	International Harvester 7.3L DT444E 1994-2005, VT365
TFW 43325HD	International Truck Navistar DT466
TFW 44059HD	International Truck Navistar DT360, DT466
TFW 44053HD	International Truck Navistar T444 V8 7.3L Diesel
TFW 44058HD	International Truck Navistar DT360, DT466
TFW 42318HD	International Truck Navistar DT408, DT466
TFW 42111HD	International V345 (5.6L)
TFW 43240HD	Mack Truck 6Cyl 11.0L, 12.0L



HALDEX WATER PUMP CROSS-REFERENCE

LIGHT TRUCK - MEDIUM TRUCK - HEAVY TRUCK

Install Haldex Water Pumps With Confidence

- Remanufactured in the USA
- Packaged in special "VCI" corrosion inhibiting poly bags
- All shafts, gears, pulleys and impellers are reconditioned to OEM specifications or replaced
- Each unit includes necessary gaskets, seals and hardware for fast, trouble-free installation
- Full one year/100,000 mile Haldex warranty

HALDEX REMAN NO.	DESCRIPTION	BEPCO NO.	GATES NO.	PRECISION NO.	SLOAN NO.
MBI RW1017X	CATERPILLAR C15, C18 STRAIGHT TOOTH GEAR	7017	-	-	-
MBI RW1017X	CATERPILLAR C15, C18 STRAIGHT TOOTH GEAR	7017	44062HD	-	-
MBI RW1073X	CUMMINS N14 ENGINE MULTI-GROOVE	7068X	44052HD	WP689	6073
MBI RW1170X	CUMMINS BIG CAM LLL & LV - 4-1/2" IMPELLER	7052X	44086HD	WP638	6052
MBI RW1172X	CUMMINS BIG CAM IV - 4-1/2" IMPELLER	7064X	44092HD	WP636	6064
MBI RW1194PX	CATERPILLAR 3406B/C - FLAT GEAR	7006X	45009HD	WP1006	6006
MBI RW4011X	CATERPILLAR 3176B, C-10 & C-12	7011X	-	WP1019	-
MBI RW4015X	CATERPILLAR 3116/3126 - 3.75" PULLEY	7015X	43554HD	WP1021	-
MBI RW4068X	CUMMINS ISX - 12 GROOVE PULLEY	-	-	-	-
MBI RW4076X	CUMMINS L10 & M11 - 1991 AFTER	7072X	43307HD	WP671	6076
MBI RW4122X	DETROIT 60 SERIES AFTER 12/90	7122X	44066HD	WP1409	6122
MBI RW4123X	DETROIT 60 SERIES - HIGH FLOW	7126X	-	WP1408	4122
MBI RW4124X	DETROIT 60 SERIES EGR - 61 TOOTH DRIVE	-	-	-	-
MBI RW4125PX	DETROIT 60 SERIES POCKET STYLE	-	-	-	6131
MBI RW6012X	CATERPILLAR 3406B/C/E - DOME GEAR	7006EX	44054HD	WP1016	6012
MBI RW6014X	CATERPILLAR C15 - STRAIGHT TOOTH	-	44051HD	WP1017	6015

⚠ WARNING: California Proposition 65 - Cancer and Reproductive Harm - www.PG5Warnings.ca.gov.

UNDER THE HOOD





SLOAN ADJUSTABLE OIL FILLER CAPS

- Creates a positive seal that cannot be bounced or jarred loose
- Tight seal virtually locks out dirt, rust and other engine damaging matter
- Available in a variety of standard sizes
- Special optional features include chain, plastic low clearance handles and shrouded caps



PART NO.	FITS FILLER I.D.	FIGURE	SPECIAL FEATURES
TWD 431093	1"	A	—
TWD 431096	1-1/4"	A	—
TWD 431099	1-3/8"	A	—
TWD 431094	1-1/2"	A	—
TWD 431095	1-1/2"	D	WITH CHAIN
TWD 431101	1-5/8"	A	—
TWD 431098	1-3/4"	A	—
TWD 431102	1-7/8"	D	WITH CHAIN
TWD 431103	2"	A	—
TWD 431104	2"	D	WITH CHAIN
TWD 431107	2-1/4"	A	—

HOW IT WORKS

As the handle is turned clockwise, the bottom plate moves upward. This action causes the grooved rubber body to expand, completing a firm, positive, airtight seal. Release with a simple, counter-clockwise turn of the handle.

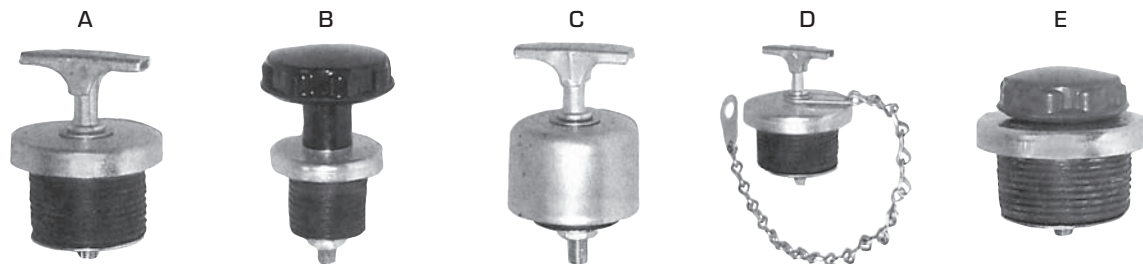

⚠ WARNING: California Proposition 65 - Cancer and Reproductive Harm - www.P65Warnings.ca.gov.

SLOAN UNIVERSAL ADJUSTABLE OIL DIPSTICKS

- Fits most makes and models
- Easy to use: cut to proper length, insert in engine filled with oil and then mark



PART NO.	SIZE	BLADE SIZE/MATERIAL
TWD 431116	31/32" X 48"	.032" X .25" SPRING STEEL
TWD 431117	31/32" X 84"	.032" X .25" SPRING STEEL

⚠ WARNING: California Proposition 65 - Cancer and Reproductive Harm - www.P65Warnings.ca.gov.





RADIATOR FAN

	PART NO.	OEM	MAKE	MODEL	YEARS
	NHD 155-9001	8-97383-808-0	ISUZU	N SERIES	NPR 2008-94, NPR HD 2008-99

⚠ WARNING: This product can expose you to chemicals including Chromium, which are known to the State of California to cause cancer and birth defects or other reproductive harm. For more information go to www.P65Warnings.ca.gov.

NAPA Thermostats

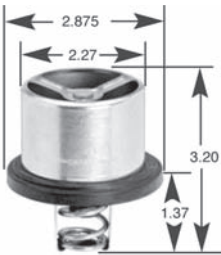
THERMOSTATS

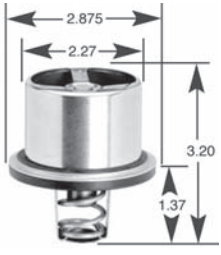
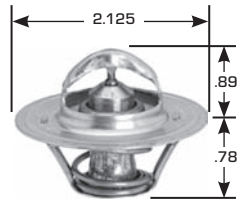
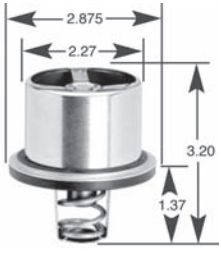
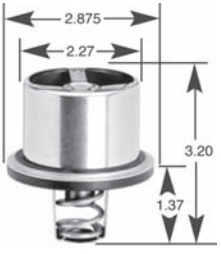
	PART NO.	DESCRIPTION		PART NO.	DESCRIPTION
	THM 613-090	190°F		THM 138	180°F
	THM 613-060	160°F		THM 169	180°F
	THM 613-070	170°F			
	THM 613-080	180°F			

UNDER THE HOOD



COOLANT RESERVOIRS & COMPONENTS



COOLANT RESERVOIRS



PART NO.	OEM	MAKE	MODEL	YEARS
NHD 448-9000	2002105C3, 2002105C2, 5C4Z-8A080-AA	NAVISTAR	3800, 4700, 4800, 4900	2002-95
NHD 448-9002	05-23045-000, 05-23045-001, 05-20529-000	FREIGHTLINER	CENTURY, COLUMBIA, CL112, CL120	2009-04
NHD 448-9003	05-23195-000, 05-21178-000, Z05-30740-000	FREIGHTLINER	M2 BUSINESS CLASS	2010-05

COOLANT TANK CAPS



PART NO.	OEM	MAKE	MODEL	YEARS
NHD 111-9000	2039390C3	NAVISTAR	4000 SERIES	2008-02
NHD 111-9001	3578833C3	NAVISTAR	9000 SERIES	2010-03
NHD 111-9002	05-20763-001	FREIGHTLINER	CENTURY, COLUMBIA, CL112, CL120	2009-04
NHD 111-9003	05-17223-002	FREIGHTLINER	M2 BUSINESS CLASS	2010-05
NHD 111-9008	5481-9916238	MACK	CV713	2008-04

⚠ WARNING: This product can expose you to chemicals including Chromium, which are known to the State of California to cause cancer and birth defects or other reproductive harm. For more information go to www.P65Warnings.ca.gov.

COOLANT TUBES



PART NO.	OEM	MAKE	MODEL	YEARS
NHD 419-9018	A05-16380-003, A05-16380-000	FREIGHTLINER	CENTURY CLASS, ARGOSY, COLUMBIA WITH DETROIT DIESEL 60 SERIES	2011-99
NHD 419-9019	A05-16384-001, A05-16384-000	FREIGHTLINER	FLD, CENTURY, COLUMBIA WITH CATERPILLAR C15	2011-90
NHD 959-9003	07-06462	PETERBILT	379, 378, 377, 357 WITH CATERPILLAR 3406E	2005-87
NHD 959-9004	K181-5141	KENWORTH	W900B, W900L, CATERPILLAR C15 3406E, & 3176	2011-90
NHD 959-9005	K181-5483	KENWORTH	T800, T600 WITH CATERPILLAR C15, 3406E	2003-90
NHD 959-9006	K181-5597	KENWORTH	W900L, W900B WITH 3406E	2011-95
NHD 959-9007	20561364, 20469768, 20462647	VOLVO	D12, N14 BYPASS TUBE	2008-01

⚠ WARNING: This product can expose you to chemicals including Nickel, which is known to the State of California to cause cancer. For more information go to www.P65Warnings.ca.gov.



WINDSHIELD WASHER RESERVOIRS



PART NO.	OEM	MAKE	MODEL	YEARS
NHD 448-9004	K114-20	KENWORTH	T SERIES, W900, C500	2002-99



COOLANT HOSES (continued)

PART NO.	DIMENSION	DESCRIPTION
NBH 641	2.75" I.D. X 36.00" OAL	HEAVY-DUTY 2-PLY
NBH 643	3.00" I.D. X 36.00" OAL	HEAVY-DUTY 2-PLY
NBH 644	3.50" I.D. X 36.00" OAL	HEAVY-DUTY 2-PLY
NBH 664	2.00" I.D. X 36.00" OAL	HEAVY-DUTY 4-PLY
NBH 666	2.25" I.D. X 36.00" OAL	HEAVY-DUTY 4-PLY
NBH 668	2.50" I.D. X 36.00" OAL	HEAVY-DUTY 4-PLY
NBH 672	3.00" I.D. X 36.00" OAL	HEAVY-DUTY 4-PLY

HEATER HOSES

PART NO.	DIMENSION	DESCRIPTION
NBH H-130	.625" I.D. X 50' BOX	STRAIGHT, HEAVY-DUTY
NBH H-131	.750" I.D. X 50' BOX	STRAIGHT, HEAVY-DUTY

UNDER THE HOOD





BELTS & DRIVE SYSTEMS

HEAVY-DUTY FLEET

DRIVEALIGN® HEAVY-DUTY AUTOMATIC BELT TENSIONERS



PART NO.	
NBH 38501	
NBH 38504	
NBH 38506	<ul style="list-style-type: none"> • Labyrinth Seal – prevents contamination of internal parts for maximum durability and service life.
NBH 38509	<ul style="list-style-type: none"> • Machined Steel Pulley – reduces surface wear while shielding internal bearing from outside contaminants.
NBH 38511	<ul style="list-style-type: none"> • Double Row Bearings – twin rows of bearings carry more load and last up to three times longer than two individual bearings.
NBH 38514	<ul style="list-style-type: none"> • Optimized Components – engineered for maximum strength and durability.
NBH 38517	<ul style="list-style-type: none"> • Patented Design – provides superior belt alignment and tension for improved drive efficiency and life.
NBH 38550	<ul style="list-style-type: none"> • Round Spring Wire – includes chrome-silicone torsion spring for less flex-fatigue than flat-wire designs.
NBH 38631	<ul style="list-style-type: none"> • Patented Damping Mechanism – provides maximum stability, reducing vibration and increasing the life of belt, tensioner and other accessory drive components.

UNDER THE HOOD





BELTS & DRIVE SYSTEMS (continued)

HEAVY-DUTY FLEET (continued)

DRIVEALIGN® HEAVY-DUTY IDLER PULLEYS



PART NO.	
NBH 36091	<p>Long-lasting pulleys built to endure the rigors of today's heavy-duty, fleet and off-road equipment.</p> <ul style="list-style-type: none"> • Superior bearings out perform OE Idler Pulleys. • Robust and high quality pulley materials to withstand contaminants. • New hardware included on some popular applications. • Built with precise dimensional tolerance to ensure proper fit and long lasting performance. • Built with corrosive-resistant coating to prevent rust and increase durability.
NBH 36223	
NBH 38028	
NBH 38053	
NBH 38075	
NBH 38076	

FLEETRANNER® HEAVY-DUTY V-BELTS

Patented EPDM construction with distinct green overcord built specifically for more durability and longer life on heavy duty drives.

- Outperforms the competition on the most troublesome drives. • Oil and heat resistant.
- Special compound provides un-matched flexibility, stability, load carrying capacity and belt life.
- Patented material provides peak performance at extreme prolonged operating temperatures.
- Heavy-duty construction resists cracking and wear. • Available in over 70 sizes.
- Unique undercord notch pattern offers increased flexibility for smaller diameter pulleys.

	PART NO.	TOP WIDTH	O.C. LENGTH (IN)
	NBH 25-9447HD	1/2	44-27/32
	NBH 25-9510HD	1/2	51-3/8
	NBH 25-9525HD	1/2	52-7/8
	NBH 25-9590HD	1/2	59-13/32
	NBH 25-9620HD	1/2	62-3/8
	NBH 25-9650HD	1/2	65-3/8

UNDER THE HOOD

J











K

CHEMICAL PRODUCTS

CLEANING PRODUCTS	320-324
TIRE REPAIR	324-325
CLEANERS & DEGREASERS	326
WINDSHIELD WASHER FLUID	326-327
ICE MELT	327



HAND CLEANERS

	PART NO.	SIZE	CASE QTY.	DESCRIPTION
	NCB 2358	1 gal. Pump Bottle	2	GOJO® Cherry Gel Pumice Hand Cleaner Gel-style, heavy-duty hand cleaner with cherry fragrance and pumice scrubbers quickly removes dirt, grease and oil. pH balanced to promote skin comfort. Provides a quick, easy, and complete rinse, leaving skin refreshed.
	NCB 1109	14 oz. Tub	12	GOJO® Original Formula™ Hand Cleaner Crème-style hand cleaner that removes grease, tar, oil and asphalt. Contains skin conditioners and cleans with or without water.
	NCB 1115	4.5 lbs. Canister	6	
	NCB 1135	4.5 lbs. Canister	6	GOJO® Original Pumice Hand Cleaner Crème-style hand cleaner with pumice scrubbers for removing difficult soils. Effective on grease, tar, oil and asphalt. Cleans with or without water.
	NCB 0915	4.5 lbs. Canister	6	GOJO® Lemon Pumice Hand Cleaner Crème-style hand cleaner with lemon fragrance and pumice scrubbers for removing difficult soils. Effective on grease, tar, oil and asphalt. Cleans with or without water.
	NCB 6396	72 ct. Bucket	6	GOJO® Scrubbing Towels Extra-large, dual textured wet shop towels for quick, convenient cleaning of oil, grease, grime, paint, dyes, tar, asphalt and adhesives from hands, tools and surfaces. SIMPUL™ nozzle is designed to keep towels wet from the first to the last – no more dry wipes. The nozzle allows only one wipe per pull – no roping. Bucket comes pre-threaded and ready to use.
	NCB 727204	2000 ml Refill	1	GOJO® Supro Max™ Hand Cleaner Fast and effective hand cleaner with walnut scrubbers removes oil, grease, paint and adhesives. Ideal for professional technicians in automotive, manufacturing, and other services and repair facilities. Non-drying formula.

CHEMICAL PRODUCTS

K





HAND CLEANERS (continued)				
	PART NO.	SIZE	CASE QTY.	DESCRIPTION
	NCB R09701	2000 mL Push-Style Dispenser	1	GOJO® PRO™ TDX™ 2000 Dispenser Large-size hand cleaner dispenser with diamond plate design. Lifetime guarantee. Compatible with GOJO® PRO TDX 2000 mL refills.
	NCB 6298	130 Ct. Bucket	4	GOJO® Fast Towels Large single textured wet shop towels remove dirt, oil and grease. Effective for cleaning hands, arms, tools and surfaces - no water needed. Contains skin moisturizers to help prevent dryness and irritation.
	NCB 6299	225 Ct. Bucket	2	
	NCB 0957	14 oz. Squeeze Bottle	12	GOJO® Natural* Orange™ Pumice Hand Cleaner Quick-acting lotion formula with fresh citrus scent and pumice scrubbing particles. Removes dirt, oil, grease and paint. * Natural citrus ingredient.
	NCB 0955	1 gal. Pump Bottle	2	

CHEMICAL PRODUCTS





K



HAND CLEANERS (continued)				
	PART NO.	SIZE	CASE QTY.	DESCRIPTION
	NCB 5000	14 oz.	12	MAC's® Waterless Hand Cleaner Crème formula for removing grease, tar and oil. Use with or without water. No harsh solvents.
	NCB 5005	4.5 lbs.	6	
	NCB 5100	14 oz.	12	MAC's® Heavy-Duty Waterless Pumice Hand Cleaner Contains pumice scrubbing particles for extra cleaning action. Use with or without water. No harsh solvents.
	NCB 5105	4.5 lbs.	6	



HAND CLEANERS (continued)

	PART NO.	SIZE	CASE QTY.	DESCRIPTION
	NCB 5115	15 oz.	12	<p>MAC's® Citrus Orange Pumice Lotion Hand Cleaner The #1 selling, biodegradable, waterless, petroleum solvent-free hand cleaner that contains no harsh chemicals, mineral oils or ammonia that can sting cuts and abrasions. Pure, fresh-smelling natural citrus power does the cleaning. Fortified with aloe, lanolin, glycerin, and other skin conditioners. Fine pumice formula gently deep cleans the toughest dirt. Works great on laundry stains, scuff marks, tile floors, pet odors and many other household cleaning needs. Suggested Applications: Resins, oil, grease, tar, grime, soil, printers' ink, epoxies, paint, rubber cement, gasket and tile cements.</p>
	NCB 5125	1 gal.	4	
	NCB 5015	15 oz.	12	<p>MAC's® Citrus Orange Smooth Lotion Hand Cleaner The #1 selling, biodegradable, waterless, petroleum solvent-free hand cleaner that contains no harsh chemicals, mineral oils or ammonia that can sting cuts and abrasions. Pure, fresh-smelling natural citrus power does the cleaning. Fortified with aloe, lanolin, glycerin, and other skin conditioners. Smooth formula gently deep cleans the toughest dirt. Works great on laundry stains, pet odors and many other household cleaning needs. Suggested Applications: Resins, oil, grease, tar, grime, soil, printers' ink, epoxies, paint, rubber cement, gasket and tile cements.</p>
	NCB 5025	1 gal.	4	
	NCB 5215	15 oz.	12	<p>MAC's® Cherry Pumice Lotion Hand Cleaner Professional strength waterless hand cleaner that removes dirt and grime quickly. Cherry fragrance eliminates petroleum odors. Fortified with aloe, lanolin, jojoba and other skin conditioners. Fine pumice formula gently deep cleans the toughest dirt. Works great on laundry stains, scuff marks, tile floors, pet odors and many other household cleaning needs. Suggested Applications: Resins, grease, grime, paint, soils, glue and printer's ink.</p>
	NCB 5225	1 gal.	4	
	NCB 5315	15 oz.	12	<p>MAC's® Cherry Smooth Lotion Hand Cleaner Professional strength waterless hand cleaner that removes dirt and grime quickly. Cherry fragrance eliminates petroleum odors. Fortified with aloe, lanolin, jojoba and other skin conditioners. Smooth formula gently deep cleans the toughest dirt. Works great on laundry stains, scuff marks, tile floors, pet odors and many other household cleaning needs. Suggested Applications: Resins, grease, grime, paint, soils, glue and printer's ink.</p>
	NCB 5325	1 gal.	4	

CHEMICAL PRODUCTS

K



HAND CLEANERS (continued)

	PART NO.	SIZE	CASE QTY.	DESCRIPTION
	NCB K0350007	3.4 oz	6	<p>O'Keeffe's® Working Hands®</p> <p>O'Keeffe's® Working Hands® Hand Cream is a concentrated hand cream that heals, relieves and repairs extremely dry, cracked hands. It is safe and effective for people with diabetes. When used daily, O'Keeffe's® Working Hands® is clinically proven to:</p> <ul style="list-style-type: none"> • Instantly boost moisture levels • Create a protective layer on the skin's surface • Help prevent further moisture loss





HAND CLEANER (continued)

	PART NO.	SIZE	CASE QTY.	DESCRIPTION
	NCB 01013	14 oz. Plastic Tub	12	<p>DL® Permatex® Blue Label™ Cream Hand Cleaner</p> <p>This cream formula waterless hand cleaner. Takes off many difficult to remove substances yet is gentle to hands. Does not leave a greasy feeling after use. The 4.5 lb. can fits most dispensers. Suggested Applications: Oil, grease, tar, grime, soil, resins, printers' ink, epoxies, paint, rubber cement, gasket and tile cements.</p>



HAND CLEANER (continued)





	PART NO.	SIZE	CASE QTY.	DESCRIPTION
	NCB 7200-01	1 gal.	4	<p>Zep® Smooth Cherry Industrial Hand Cleaner with Waterless Rinsing</p> <p>No matter where you are, this smooth, no pumice cherry hand cleaner makes it easy to clean hands while effectively eliminating the strong odors found in many industrial settings.</p> <ul style="list-style-type: none"> • May be used with or without water • Excellent cleaning action • Cherry fragrance eliminates petroleum odors • Contains no abrasives to irritate skin
	NCB R10901	500 ml.	12	<p>Zep® Alcohol Hand Sanitizing Gel</p> <p>Controls many of the microorganisms that are of public health concern. Enables the instant, thorough sanitizing of hands without water. Kills potentially harmful microorganisms. Convenient to use anywhere.</p> <ul style="list-style-type: none"> • Evaporates quickly • Leaves no sticky feeling • Broad spectrum sanitizing • No water needed

CHEMICAL PRODUCTS

K



HAND CLEANERS (continued)

	PART NO.	SIZE	CASE QTY.	DESCRIPTION
	NCB R04825	1 gal.	4	<p>Zep® Cherry Classic Industrial Hand Cleaner with Pumice This heavy duty hand soap is tough on dirt and grime, and gentle on hard-working hands. It is formulated to remove stubborn industrial soils such as inks, resins, paints, adhesives, tar, carbon, and asphalt.</p> <ul style="list-style-type: none"> •Pumice •Moisturizes hands •Cherry fragrance eliminates grease/solvent odors
	NCB R05125	1 gal.	4	<p>Zep® Orange Classic Industrial Hand Cleaner with Pumice Heavy-duty, citrus scented hand cleaner with pumice. Uses citrus solvents to remove tough greases, oils, and odors.</p> <ul style="list-style-type: none"> •Powerful citrus solvents remove tough soils •Pumice formulation designed to remove toughest grime •Orange fragrance leaves hands smelling fresh
	NCB R05360	1 gal.	4	<p>Zep® Walnut Paste Industrial Hand Cleaner with Scrubbing Shells A premium paste formula with thousands of scrubbing shells combine in a powerful, environmentally responsible solvent, surfactant blend.</p> <ul style="list-style-type: none"> •Rich, soothing paste formula leaves hand fresh •Less scrubbing and environmentally responsible •Reduced settling in drains and traps with floating shell pieces
	NCB R09701	-	-	<p>Zep® D-4000 Plus Dispenser Industrial grade dispensing system that offers a sleek appearance with the durability of stainless steel internal components. For our one-gallon hand care products Dispenses the right volume of any type cleaner Years of service even in the toughest settings</p>

CHEMICAL PRODUCTS

K







TIRE REPAIR

	PART NO.	SIZE	CASE QTY.	DESCRIPTION
	NCB 60174	16 oz.	6	<p>Slime® Thru-Core Emergency Sealant Changing an emergency flat tire just got easier. Slime's Thru-Core™ Tire Sealant seeks out and instantly seals tread area punctures up to 1/4" diameter. There is no need to remove the valve core. Slime's Thru-Core Technology™ seamlessly injects the new sealant formula through the valve stem directly into the tire. Then just air up your tire with an inflator to get back on the road quickly. Slime Thru-Core™ Tire sealant is non-toxic, non-corrosive and tire sensor safe. This new easy install formula is tested and approved by leading automakers and cleans up easily with water.</p>



TIRE REPAIR (continued)



	PART NO.	SIZE	CASE QTY.	DESCRIPTION
	NCB SLIME10008	24 oz. for ATV's, Mowers and Golf Cars	6	<p>Slime® Flat Preventative Tire Sealant Prevent and repair punctures for up to two years in all your non-highway vehicle tires, including tractors, trailers, lawn mowers, wheelbarrows, golf carts, ATVs/UTVs and more. Don't let a flat tire ruin your fun! No more flats! Slime's Prevent & Repair Tire Sealant seeks out and instantly seals tread area punctures in tubeless tires up to 1/4" (6mm). When a puncture occurs, our patented sealant is carried directly to the source. The pressure of the escaping air forces the particles into the opening, where they build up and intertwine to form a long-lasting, flexible plug. Instantly, air loss is blocked and a flat tire is prevented. Install in any of your tubeless non-highway vehicles (including ATVs/UTVs, golf carts, riding lawn mowers, small trailers, tractors, scooters and much more) and enjoy two years of continuous flat tire protection.</p> <ul style="list-style-type: none"> • Instantly seals up to 1/4" (6mm) punctures • Seals punctures for up to 2 years • Stops slow leaks • Safe and easy • Great for preventing flat tires in: ATVs/UTVs, golf carts, riding lawn mowers, small trailers, tractors, scooters and all other non-highway tubeless tires.
	NCB SLIME10009	32 oz. For all tubeless tires	6	
	NCB 10163	1-gallon for shop, construction and agricultural use. Includes pump.	—	
	NCB SLIME10011	16 oz.	6	

CHEMICAL PRODUCTS

K



CLEANERS & DEGREASERS

	PART NO.	SIZE	CASE QTY.	DESCRIPTION
	NCB 3520P	1 gal.	6	<p>Purple Power® Driveway and Concrete Cleaner Removes oil and grease stains from concrete, warehouse floors, driveways, parts and equipment. In just seconds the professional-strength formula cuts grease, oil stains and grime. Do not use on asphalt or sealer coats.</p> <ul style="list-style-type: none"> • Cleans oil and grease stains on contact • May be diluted with water (depending on surface to be cleaned)
	NCB 85055G	5 gal.	—	<p>Purple Power® Steam Cleaning Compound A liquid steam cleaning compound for all types of cleaning. A powerful, low-foam cleaning system combined with special solvents to quickly liquify and remove grease, tar, and heavy oil.</p>

CHEMICAL PRODUCTS

K





WINDSHIELD WASHER FLUID

	PART NO.	SIZE	CASE QTY.	DESCRIPTION
	NCB KIN16	16 oz.	6	<p>Super K Concentrated Windshield Washer Fluid</p> <ul style="list-style-type: none"> • Highly-concentrated windshield washer fluid. • One 16 oz. bottle makes 165 gallons of premium washer fluid • 3 pumps=1 gallon • 1/2 a bottle makes a 55-gallon drum • Easy to use



WINDSHIELD WASHER FLUID (continued)

	PART NO.	SIZE	CASE QTY.	DESCRIPTION
	WWS RX68106	1 gal.	6	Rain-X® -25°F Deicer • Repels light snow and ice • Helps repel road spray • Instantly applies Rain X water beading technology Note: Not for sale or use in California.
	WWS 5061320	1 gal.	6	Rain-X® 0°F All Season Repels Light Snow & Ice • Helps repel road spray • Powers off bugs and road grime • Instantly applies Rain X water beading technology
	WWS RX68806	1 gal.	6	Rain-X® +32°F Bug Remover • Repels light snow and ice • Helps repel road spray • Powers off bugs and road grime • Instantly applies Rain X water beading technology

⚠ ANTIFREEZE – WARNING: Reproductive Harm - www.P65Warnings.ca.gov
 WINDSHIELD WASH – including any products containing Methanol: WARNING: Reproductive Harm - www.P65Warnings.ca.gov
 HERCULINER - WARNING: Cancer and Reproductive Harm - www.P65Warnings.ca.gov
 ELECTRONICS – WARNING: Cancer and Reproductive Harm - www.P65Warnings.ca.gov
 LIGHTING PRODUCTS: WARNING: Cancer and Reproductive Harm - www.P65Warnings.ca.gov
 DIESEL ADDITIVES (Each product may vary depending on the chemical(s) within the formula): WARNING: Cancer and Reproductive Harm - www.P65Warnings.ca.gov

ROAD RUNNER® ICE MELT

- Contains calcium chloride pellets; the fastest de-icer available
- Begins melting ice and snow immediately upon contact and quickly generates melting heat
- Fewer applications required for excellent results
- Safer on concrete and vegetation than rock salt when used correctly
- Effectively melts ice and snow temperatures down to -15°F

	PART NO.	SIZE		PART NO.	SIZE
	NCB 00029	12 lb. Shaker Jug		NCB 00020	20 lb. Bag

CHEMICAL PRODUCTS

K

PART NUMBERS INDEX

B

BAT 7204	296
BAT 7212	296
BAT 7218	296
BAT 7231	297
BAT 7234	297
BAT 7236	297
BAT 7238	297
BAT 7244	296
BAT 7248	296
BAT 7263	296
BAT 7264D	296
BAT 7266	296
BAT 7269	296
BAT 7271	296
BAT 7271FT	296
BAT 9273	296
BAT 9275	296
BAT 9831DT	297
BAT 9833	297
BAT 9835	297
BEL 736102	298
BEL 736103	298
BEL 736104	298
BEL 736105	298
BEL 736106	298
BEL 736107	298
BEL 736150	298
BEL 736151	298
BEL 736152	298
BEL 736153	298
BEL 736154	298
BEL 736155	298
BEL 736156	298
BEL 736157	298
BEL 736161	298
BEL 736162	298
BEL 736163	298
BEL 736164	298
BK 782-5251	302
BK 782-5252	302
BK 782-5259	302

G

GRO 07001-4	239
GRO 40062	269
GRO 40063	269
GRO 40132	269
GRO 40133	269
GRO 40641	272
GRO 40650	272
GRO 41012	269
GRO 41013	269
GRO 41032	269
GRO 41033	269
GRO 41050	272
GRO 41133	272
GRO 41142	269
GRO 41143	269
GRO 41152	269
GRO 41153	269
GRO 41160	272
GRO 43100	256
GRO 43253	254
GRO 43362	256
GRO 43390	249
GRO 43572	253
GRO 43690	247
GRO 43780	249
GRO 43850	249
GRO 44530	285
GRO 44710	285
GRO 44810	285
GRO 44891	285
GRO 45583	249
GRO 45812	244
GRO 45813	244
GRO 45822	241
GRO 45823	241
GRO 45832	244

GRO 45833	244
GRO 46143	243
GRO 46412	249
GRO 46413	249
GRO 46742	249
GRO 46743	249
GRO 46792	249
GRO 46793	249
GRO 46872	249
GRO 46873	249
GRO 47072	247
GRO 47073	247
GRO 47092	247
GRO 47093	247
GRO 47122	243
GRO 47123	243
GRO 47242	247
GRO 47243	247
GRO 49082	250
GRO 49172	250
GRO 49182	250
GRO 49192	250
GRO 50792	253
GRO 52182	255
GRO 52193	255
GRO 52513	255
GRO 52672	252
GRO 52772	252
GRO 52773	252
GRO 52892	255
GRO 52893	255
GRO 52922	252
GRO 53063	249
GRO 53102	252
GRO 53252	251
GRO 53253	251
GRO 53962	255
GRO 53963	255
GRO 54332	251
GRO 54342	251
GRO 54672	255
GRO 54682	255
GRO 56150-5	257
GRO 56160-5	257
GRO 56170-5	257
GRO 56180-5	257
GRO 60001	259
GRO 60261	259
GRO 60271	260
GRO 60280	259
GRO 60291	259
GRO 60381	259
GRO 60411	260
GRO 60421	260
GRO 60671	259
GRO 60681	259
GRO 60721	259
GRO 61261	261
GRO 61291	261
GRO 61E41	257
GRO 61H91	261
GRO 62171	257
GRO 62231	255
GRO 62271	257
GRO 62691	257
GRO 63151-5	267
GRO 63161-5	267
GRO 63171-5	267
GRO 63241-5	267
GRO 63571	264
GRO 63581	264
GRO 63591	264
GRO 63601-5	264-265
GRO 63610	264-265
GRO 63611-5	264-265
GRO 63621-5	264-265
GRO 63731	264-265
GRO 63741-5	264-265
GRO 63751-5	264-265
GRO 63761	264
GRO 63821-5	265

GRO 63831-5	265
GRO 63861-5	265
GRO 63871-5	265
GRO 63981-5	266
GRO 63991-5	266
GRO 63E41	264
GRO 63F31	265
GRO 63F51	265
GRO 63F61	265
GRO 63F71	265
GRO 63G01	265
GRO 63G11	265
GRO 63J01	264
GRO 63J11	264
GRO 63J21	264
GRO 63J31	264
GRO 64H01-5	266
GRO 66815	262
GRO 66843	262
GRO 66850	262
GRO 66861	262
GRO 66910	262
GRO 66931	262
GRO 67000	262
GRO 67001	262
GRO 67002	262
GRO 67010	263
GRO 67050	263
GRO 67090	263
GRO 68380	263
GRO 68680	263
GRO 71422	233
GRO 76253	271
GRO 76683	272
GRO 76813	272
GRO 76943	272
GRO 76953	272
GRO 76963	272
GRO 76983	273
GRO 76993	273
GRO 77103	273
GRO 77123	270
GRO 77163	273
GRO 77353	270
GRO 77363	270
GRO 77463	271
GRO 77913	273
GRO 77933	271
GRO 78853	271
GRO 81-0012-C	127
GRO 81-0015	127
GRO 81-0015	273
GRO 81-0015-40	127
GRO 81-0015-40	273
GRO 81-0015-40B	127
GRO 81-0015-40C	127
GRO 81-0015-40R	127
GRO 81-0015-B	127
GRO 81-0015-C	127
GRO 81-0015-R	127
GRO 81-0020-C	127
GRO 82-1000	284
GRO 82-2100	285
GRO 82-2116	285
GRO 82-2120	285
GRO 82-2125	285
GRO 82-2130	285
GRO 82-2134	285
GRO 82-2164	284
GRO 82-2165	284
GRO 82-2166	284
GRO 84-1006	263
GRO 87101	273
GRO 91400	246
GRO 91410	246
GRO 91740	254
GRO 91950	254
GRO 92070	246
GRO 92120	243
GRO 92420	256
GRO 92513	254

GRO 92720	256
GRO G1002	243
GRO G1003	243
GRO G1032	243
GRO G1033	243
GRO G1082	245
GRO G1083	245
GRO G3002	240
GRO G3003	240
GRO G3092	242
GRO G3093	242
GRO G4002	251
GRO G5082-5	257
GRO G5092-5	257
GRO G5300	258
GRO G5530	258
GRO G5540	258
GRO G5543	258
GRO G6002	255

L

LIT 10050R	244
LIT 10202R	244
LIT 10203R	245
LIT 10203Y	245
LIT 10205R	244
LIT 10205Y	244
LIT 10212Y	244
LIT 10250R	244
LIT 10250Y	244
LIT 10414	245
LIT 1050	244
LIT 1050A	244
LIT 10700	246
LIT 10702	246
LIT 10704	247
LIT 10725	245
LIT 10729	253
LIT 1075	245
LIT 1075A	245
LIT 1211	248
LIT 1211A	248
LIT 15011	258
LIT 15200C	260
LIT 15200R	248
LIT 15200Y	248
LIT 15205	261
LIT 15208	259
LIT 1560	248
LIT 1560A	248
LIT 15720	250
LIT 15741R	250
LIT 190	286
LIT 191	286
LIT 192-4	286
LIT 19200C	260
LIT 19200R	248
LIT 19200Y	248
LIT 19250R	248
LIT 19250Y	248
LIT 192D	286
LIT 194	286
LIT 195	286
LIT 1960	248
LIT 1960A	248
LIT 19721	250
LIT 21002R	248
LIT 21002Y	248
LIT 21204C	259
LIT 26330	261
LIT 26335	259
LIT 2660	248
LIT 2660A	248
LIT 27270C	236
LIT 27450C	236
LIT 27640C	236
LIT 27645C	236
LIT 29203R	248
LIT 29203Y	248
LIT 30200R	241

LIT 30200Y	241
LIT 30201R	242
LIT 30201Y	242
LIT 30250R	240
LIT 30250Y	240
LIT 3050	240
LIT 3050A	240
LIT 30700	242
LIT 30702	242
LIT 3075	241
LIT 3075A	241
LIT 33050R	240
LIT 33050Y	240
LIT 33075Y	240
LIT 35001R	248
LIT 35001Y	248
LIT 35200R	248
LIT 35200Y	248
LIT 36041C	259
LIT 40202R	252
LIT 40204	258
LIT 40242R	252
LIT 40282R	252
LIT 40282Y	252
LIT 40285R	252
LIT 4050	251
LIT 4050A	251
LIT 4060C	258
LIT 40700	254
LIT 40720	253
LIT 40725	253
LIT 40756	253
LIT 40757	253
LIT 44030R	251
LIT 44102Y	270
LIT 44302R	251
LIT 44322R	251
LIT 44438C	260
LIT 44700	254
LIT 44701	254
LIT 44705	254
LIT 45	268
LIT 45A	268
LIT 47	268
LIT 47A	268
LIT 49202R	252
LIT 54	268
LIT 54A	268
LIT 60120Y	270
LIT 60202R	256
LIT 60202Y	256
LIT 60204C	258
LIT 60215Y	256
LIT 60250R	255
LIT 6050	255
LIT 6050A	255
LIT 6060C	258
LIT 60700	256
LIT 60704	256
LIT 60709	256
LIT 60720	256
LIT 60729	256
LIT 69202Y	256
LIT 80220	236, 266
LIT 80251C	261
LIT 80255C	260
LIT 80350	260
LIT 80351	260
LIT 81360	266
LIT 81365	266
LIT 8140	266
LIT 81500	266
LIT 8155	266
LIT 8160	266
LIT 8170	266
LIT 8180	266
LIT 9185	286
LIT 92564Y	271
LIT 92565-Y	271
LIT 92565Y	271
LIT 97940	263

LIT 97944	263
LIT 97946-3	263
LIT 98175R	267
LIT 98175Y	267
LIT 98176R	267
LIT 98176Y	267

M

MBI 051U80-6N	51
MBI 11401	125
MBI 11402	125
MBI 1212015	98
MBI 40010001	22
MBI 40010008	22
MBI 40010013	22
MBI 40010070	22
MBI 40010121	22
MBI 40010140	22
MBI 40010141	22
MBI 40010142	22
MBI 40010143	22
MBI 40010144	22
MBI 40010155	22
MBI 40010156	22
MBI 40010211	22
MBI 40010212	22
MBI 40010214	22
MBI 40010215	22
MBI 40010216	23
MBI 40020211	23
MBI 40020212	23
MBI 40020215	23
MBI 40020216	23
MBI 42710553	24
MBI 42710558	23
MBI 42710563	24
MBI 44310204	24
MBI 44310318	24
MBI 45210058	24
MBI 45210125	23
MBI 45210128	24
MBI 45210129	24
MBI 48100225	135
MBI 48100367	136
MBI 48100374	136
MBI 48100375	136
MBI 90555105	135
MBI 90555108	134
MBI 90555263	133
MBI 90555318	133
MBI 90555335	134
MBI 90555353	133
MBI 90555375	134
MBI 90555376	134
MBI 90555425	136
MBI 90555426	136
MBI A39219	106
MBI A48373	106
MBI A72420	106
MBI A75962	106
MBI AL10271914	92
MBI AL10271915	92
MBI AL1027196	92
MBI AL1364040	88
MBI AL1364041	89
MBI AL430614	89
MBI AL430624	89
MBI AL430668	89
MBI AL919338	91
MBI AL919342	91
MBI AL919803	92
MBI AQ15473	92
MBI AQ960502	91
MBI AQ960503	90
MBI AQ963002	88

MBI AQ963005	88
MBI AQ963011	90
MBI AQ964110	91
MBI AQ964111	91
MBI CB30S1	99
MBI CF1	99
MBI CF2	99
MBI CF3	99
MBI CQ65477	49
MBI CQ65481	49
MBI CQ65642	50
MBI CQ66867	51-52
MBI CQ66917	48
MBI CQ67319	48
MBI CQ69001	50
MBI DA909005	125
MBI DP30	99
MBI DS1	99
MBI GC1308EG	48
MBI GC1308EJ	48
MBI GC1308EN	48
MBI GC1308ER	48
MBI GC1308Q2G	50
MBI GC1308Q2J	50
MBI GC1308Q2N	50
MBI GC1308Q2R	50
MBI GC1443EG	48
MBI GC1443ER	48
MBI GC3030	97
MBI GC3030CW	97
MBI GC3030L	97
MBI GC3030LCW	97
MBI GC3030LS4CW	97
MBI GC3030LS5CW	97
MBI GC3030S4CW	97
MBI GC3030S5CW	97
MBI GC4311EG	48
MBI GC4311EJ	48
MBI GC4311EN	48
MBI GC4311ER	48
MBI GC4515QG	51
MBI GC4515QJ	51
MBI GC4515QN	51
MBI GC4515QR	51
MBI GC4702QG	50
MBI GC4702QN	50
MBI GC4702QR	50
MBI GC4709ES2G	49
MBI GC4709ES2J	49
MBI GC4709ES2N	49
MBI GC4709ES2R	49
MBI GC4709ESG	49
MBI GC4709ESJ	49
MBI GC4709ESN	49
MBI GC4709ESR	49
MBI GD4311EG	48
MBI GD4311EJ	48
MBI GD4311EN	48
MBI GD4311ER	48
MBI GD4515QG	51
MBI GD4515QJ	51
MBI GD4515QN	51
MBI GD4515QR	51
MBI GD4709ES2G	49
MBI GD4709ES2J	49
MBI GD4709ES2N	49
MBI GD4709ES2R	49
MBI GD4709ESG	49
MBI GD4709ESJ	49
MBI GD4709ESN	49
MBI GD4709ESR	49
MBI GF1308EJ	48
MBI GF1308EN	48
MBI GF1308Q2J	50
MBI GF1308Q2N	50
MBI GF1443EJ	48
MBI GF1443EN	48
MBI GF4311EG	48
MBI GF4311EJ	48
MBI GF4311EN	48
MBI GF4311ER	48

MBI GF4515QG	51
MBI GF4515QJ	51
MBI GF4515QN	51
MBI GF4515QR	51
MBI GF4702QJ	50
MBI GF4702QN	50
MBI GF4707QG	52
MBI GF4707QJ	52
MBI GF4707QN	52
MBI GF4707QR	52
MBI GF4709ES2G	49
MBI GF4709ES2J	49
MBI GF4709ES2N	49
MBI GF4709ES2R	49
MBI GF4709ESG	49
MBI GF4709ESJ	49
MBI GF4709ESN	49
MBI GF4709ESR	49
MBI GG1308EG	48
MBI GG1308EJ	48
MBI GG1308EN	48
MBI GG1308ER	48
MBI GG1308Q2G	50
MBI GG1308Q2J	50
MBI GG1308Q2N	50
MBI GG1308Q2R	50
MBI GG1443EG	48
MBI GG1443EJ	48
MBI GG1443EN	48
MBI GG1443ER	48
MBI GG4311EG	48
MBI GG4311EJ	48
MBI GG4311EN	48
MBI GG4311ER	48
MBI GG4515QG	51
MBI GG4515QJ	51
MBI GG4515QN	51
MBI GG4515QR	51
MBI GG4702QG	50
MBI GG4702QJ	50
MBI GG4702QN	50
MBI GG4702QR	50
MBI GG4707QG	52
MBI GG4707QJ	52
MBI GG4707QN	52
MBI GG4707QR	52
MBI GG4709ES2G	49
MBI GG4709ES2J	49
MBI GG4709ES2N	49
MBI GG4709ES2R	49
MBI GG4709ESG	49
MBI GG4709ESJ	49
MBI GG4709ESN	49
MBI GG4709ESR	49
MBI GM4311EG	48
MBI GM4311EJ	48
MBI GM4311EN	48
MBI GM4311ER	48
MBI GM4515QG	51
MBI GM4515QJ	51
MBI GM4515QN	51
MBI GM4515QR	51
MBI GM4707QG	52
MBI GM4707QR	52
MBI GN4311EG	48
MBI GN4311EJ	48
MBI GN4311EN	48
MBI GN4311ER	48
MBI GN4515QG	51
MBI GN4515QJ	51
MBI GN4515QN	51
MBI GN4515QR	51
MBI GN4707QG	52
MBI GN4707QJ	52
MBI GN4707QN	52
MBI GN4707QR	52
MBI GN4709ES2G	49
MBI GN4709ES2J	49
MBI GN4709ES2N	49
MBI GN4709ES2R	49
MBI GN4709ESG	49
MBI GN4709ESJ	49
MBI GN4709ESN	49
MBI GN4709ESR	49



PART NUMBERS INDEX

MBI GP3030K.....	97
MBI GP3030LK.....	97
MBI GP4311EN.....	48
MBI GP4311ER.....	48
MBI GP4515QG.....	51
MBI GP4515QJ.....	51
MBI GP4515QN.....	51
MBI GP4515QR.....	51
MBI GP4707QG.....	52
MBI GP4707QJ.....	52
MBI GP4707QN.....	52
MBI GP4707QR.....	52
MBI GP4709ES2G.....	49
MBI GP4709ES2R.....	49
MBI GP4709ESG.....	49
MBI GP4709ESR.....	49
MBI GR1308EG.....	48
MBI GR1308EJ.....	48
MBI GR1308EN.....	48
MBI GR1308ER.....	48
MBI GR1308Q2G.....	50
MBI GR1308Q2J.....	50
MBI GR1308Q2N.....	50
MBI GR1308Q2R.....	50
MBI GR4311EG.....	48
MBI GR4311EJ.....	48
MBI GR4311EN.....	48
MBI GR4311ER.....	48
MBI GR4515QG.....	51
MBI GR4515QJ.....	51
MBI GR4515QN.....	51
MBI GR4515QR.....	51
MBI GR4702QG.....	50
MBI GR4702QJ.....	50
MBI GR4702QN.....	50
MBI GR4702QR.....	50
MBI GR4707QG.....	52
MBI GR4707QJ.....	52
MBI GR4707QN.....	52
MBI GR4707QR.....	52
MBI GR4709ES2G.....	49
MBI GR4709ES2J.....	49
MBI GR4709ES2N.....	49
MBI GR4709ES2R.....	49
MBI GR4709ESG.....	49
MBI GR4709ESJ.....	49
MBI GR4709ESN.....	49
MBI GR4709ESR.....	49
MBI GZ4515QG.....	51
MBI GZ4515QN.....	51
MBI GZ4515QR.....	51
MBI GZ4707QG.....	52
MBI GZ4707QN.....	52
MBI GZ4707QR.....	52
MBI GZ4709ES2G.....	49
MBI GZ4709ES2J.....	49
MBI GZ4709ES2R.....	49
MBI GZ4709ESG.....	49
MBI GZ4709ESR.....	49
MBI HD3030KIT.....	98
MBI KN20001.....	112
MBI KN20110.....	112
MBI KN26020.....	114
MBI KN27000.....	114
MBI KN27000.....	135
MBI KN27013.....	135
MBI KN27201.....	135
MBI KN28060.....	112
MBI KN28510.....	111
MBI KN28520.....	111
MBI KN28600.....	113
MBI KN30400.....	114
MBI KN31060.....	112
MBI KN34110.....	113
MBI KN68230.....	113
MBI RT1.....	99
MBI RTP1.....	99
MBI RTP2.....	99
MBI RW1017X.....	311
MBI RW1073X.....	311
MBI RW1170X.....	311

MBI RW1172X.....	311
MBI RW1194PX.....	311
MBI RW4011X.....	311
MBI RW4015X.....	311
MBI RW4068X.....	311
MBI RW4076X.....	311
MBI RW4122X.....	311
MBI RW4123X.....	311
MBI RW4124X.....	311
MBI RW4125PX.....	311
MBI RW6012X.....	311
MBI RW6014X.....	311
MBI SC09.....	98
MBI SC16.....	98
MBI SC20.....	98
MBI SC24.....	98
MBI SC30.....	98

N

NBH 25-9447HD.....	317
NBH 25-9510HD.....	317
NBH 25-9525HD.....	317
NBH 25-9590HD.....	317
NBH 25-9620HD.....	317
NBH 25-9650HD.....	317
NBH 36091.....	317
NBH 36223.....	317
NBH 38028.....	317
NBH 38053.....	317
NBH 38075.....	317
NBH 38076.....	317
NBH 38501.....	316
NBH 38504.....	316
NBH 38506.....	316
NBH 38509.....	316
NBH 38511.....	316
NBH 38514.....	316
NBH 38517.....	316
NBH 38550.....	316
NBH 38631.....	316
NBH 641.....	315
NBH 643.....	315
NBH 644.....	315
NBH 664.....	315
NBH 666.....	315
NBH 668.....	315
NBH 672.....	315
NBH H-130.....	315
NBH H-131.....	315
NCB 00020.....	327
NCB 00029.....	327
NCB 01013.....	323
NCB 0915.....	320
NCB 0955.....	321
NCB 0957.....	321
NCB 10163.....	325
NCB 1109.....	320
NCB 1115.....	320
NCB 1135.....	320
NCB 2358.....	320
NCB 3520P.....	326
NCB 5000.....	321
NCB 5005.....	321
NCB 5015.....	322
NCB 5025.....	322
NCB 5100.....	321
NCB 5105.....	321
NCB 5115.....	322
NCB 5125.....	322
NCB 5215.....	322
NCB 5225.....	322
NCB 5315.....	322
NCB 5325.....	322
NCB 60174.....	324
NCB 6298.....	321
NCB 6299.....	321
NCB 6396.....	320
NCB 7200-01.....	323
NCB 727204.....	320
NCB 85055G.....	326

NCB K0350007.....	323
NCB KIN16.....	326
NCB R04825.....	324
NCB R05125.....	324
NCB R05360.....	324
NCB R09701.....	321, 324
NCB R10901.....	323
NCB SLIME10008.....	325
NCB SLIME10009.....	325
NCB SLIME10011.....	325
NHD 111-9000.....	314
NHD 111-9001.....	314
NHD 111-9002.....	314
NHD 111-9003.....	314
NHD 111-9008.....	314
NHD 155-9001.....	313
NHD 218-9000.....	239
NHD 223-9000.....	224
NHD 223-9001.....	224
NHD 223-9002.....	224
NHD 223-9003.....	224
NHD 223-9004.....	224
NHD 223-9005.....	224
NHD 223-9006.....	224
NHD 223-9007.....	224
NHD 223-9008.....	224
NHD 223-9009.....	224
NHD 223-9010.....	224
NHD 223-9011.....	224
NHD 223-9012.....	224
NHD 223-9013.....	224
NHD 223-9014.....	224
NHD 223-9015.....	224
NHD 223-9016.....	224
NHD 223-9017.....	224
NHD 223-9018.....	224
NHD 223-9019.....	224
NHD 419-9004.....	239
NHD 419-9018.....	314
NHD 419-9019.....	314
NHD 448-9000.....	314
NHD 448-9002.....	314
NHD 448-9003.....	314
NHD 448-9004.....	315
NHD 656-9000.....	225
NHD 656-9001.....	225
NHD 656-9002.....	225
NHD 656-9006.....	225
NHD 656-9007.....	225
NHD 656-9008.....	225
NHD 656-9009.....	225
NHD 656-9011.....	225
NHD 656-9012.....	225
NHD 656-9013.....	225
NHD 800-5107.....	237
NHD 800-5108.....	237
NHD 800-5109.....	237
NHD 800-5110.....	237
NHD 800-5203.....	237
NHD 800-5204.....	237
NHD 800-5205.....	237
NHD 800-5206.....	237
NHD 800-5403.....	237
NHD 800-5404.....	237
NHD 800-5501.....	237
NHD 800-5502.....	237
NHD 800-5503.....	237
NHD 800-5504.....	237
NHD 800-5505.....	237
NHD 800-5506.....	237
NHD 800-5507.....	237
NHD 800-5508.....	237
NHD 800-9000.....	237
NHD 800-9001.....	237
NHD 800-9002.....	237
NHD 800-9003.....	237
NHD 800-9004.....	237
NHD 800-9005.....	237
NHD 800-9006.....	237
NHD 800-9007.....	237
NHD 904-5201CD.....	199

NHD 904-5301CD.....	199
NHD 904-5401CD.....	199
NHD 904-5501CD.....	199
NHD 904-5502CD.....	199
NHD 904-5601CD.....	199
NHD 904-5602CD.....	199
NHD 904-5701CD.....	199
NHD 959-9003.....	314
NHD 959-9004.....	314
NHD 959-9005.....	314
NHD 959-9006.....	314
NHD 959-9007.....	314
NHD 988-5101.....	238
NHD 988-5102.....	238
NHD 988-5201.....	238
NHD 988-5202.....	238
NHD 988-5207.....	238
NHD 988-5208.....	238
NHD 988-5209.....	238
NHD 988-5210.....	238
NHD 988-5405.....	238
NHD 988-5406.....	238
NHD 988-5409.....	238
NHD 988-5410.....	238
NHD 988-5501.....	238
NHD 988-5502.....	238
NHD 988-5503.....	238
NOS 27438.....	80
NOS 28758.....	80
NOS 35058.....	80
NOS 35066.....	80
NOS 38776.....	80
NOS 38780.....	80
NOS 40129.....	80
NOS 40136.....	80
NOS 42623.....	80
NOS 42627.....	80
NOS 42672.....	80
NOS 42673.....	80
NOS 43761.....	80
NOS 43764.....	80
NOS 46300.....	80
NOS 46305.....	80
NOS 47691.....	80
NOS 47697.....	80
NS 555001.....	169
NS 555010.....	169
NS 555032.....	169
NS 555033.....	169
NS 557001.....	169
NS 557003.....	169
NS 557004.....	169
NS 557007.....	169
NS 65101.....	168
NS 65102.....	168
NS 65103.....	168
NS 65105.....	168
NS 65402.....	168
NS 65404.....	168
NS 65408.....	168
NS 65409.....	168
NS 65420.....	169
NS 65490.....	169
NS 66104.....	169
NS 66118.....	169
NS 66123.....	169
NS 66143.....	169
NS 66145.....	169
NS 66147.....	169
NS 66159.....	169
NS 66605.....	168
NS 66628.....	168
NS 66637.....	168
NS 66833.....	168
NS 66861.....	168
NS 66893.....	168
NS 66913.....	168
NS 66923.....	168
NS 74025.....	169
NS 74028.....	169

NTH 90-100-1 72
 NTH 90-184-1 72
 NTH 90-259 72
 NTH 90-260 72
 NTH 90-275 72
 NTH 90-279 72
 NTH 90-302 72
 NTH 90-305 72
 NTH 90-306 72
 NTH 90-376 73
 NTH 90-388 73
 NTH 90-5002 73
 NTH 90-5006 73
 NTH 90-5010 73
 NTH 90-5261 73
 NTH 90-612 72
 NTH 90-618 72
 NTH 90-670 72
 NTH 90-674 72
 NW 728005 301
 NW 728006 302
 NW 728033 301
 NW 728034 301
 NW 728035 301
 NW 728036 301
 NW 728037 301
 NW 728038 301
 NW 728039 301
 NW 728040 301
 NW 728060 301
 NW 728101 301
 NW 728103 301
 NW 728104 301
 NW 728105 301
 NW 728106 301
 NW 728107 301
 NW 728199 302
 NW 728302 302
 NW 728552 301
 NW 728554 301
 NW 728555 301
 NW 785905 301

P

PHI 11-31509 126
 PHI 11-3159 126
 PHI 11-3409 126
 PHI 11-5150 126
 PHI 11-5200 126
 PHI 11-5400 126
 PHI 11-8112 126
 PHI 11-8115 126
 PHI 11-8120 126
 PHI 12-006 119
 PHI 12-008 119
 PHI 12-010 119
 PHI 12-0161 124
 PHI 12-0162 124
 PHI 12-0163 124
 PHI 12-0164 124
 PHI 12-038 125
 PHI 12-039 125
 PHI 12-136 120
 PHI 12-138 120
 PHI 12-206 120
 PHI 12-306 120
 PHI 12-308 120
 PHI 12-316 120
 PHI 12-318 120
 PHI 12-600 123
 PHI 15-042 124
 PHI 15-320 280
 PHI 15-326 280
 PHI 15-335 278
 PHI 15-336 278
 PHI 15-400 280
 PHI 15-430 278
 PHI 15-600 280
 PHI 15-630 278
 PHI 15-720 280

PHI 15-730 277
 PHI 15-740 282
 PHI 15-760 281
 PHI 15-762 281
 PHI 15-7629 281
 PHI 15-763 281
 PHI 15-769 282
 PHI 15-830 277
 PHI 16-713 278
 PHI 16-720 279
 PHI 16-722 279
 PHI 16-726 279
 PHI 16-730 277
 PHI 16-762 281
 PHI 16-775 282
 PHI 16-822 279
 PHI 17-0240 124
 PHI 17-0400 124
 PHI 17-0401 124
 PHI 17-111 129
 PHI 17-116 129
 PHI 17-120 129
 PHI 17-125 129
 PHI 17-148 124
 PHI 17-1488 124
 PHI 17-420 124
 PHI 22-2071 275
 PHI 22-4621 274
 PHI 22-4721 274
 PHI 22-9721 275
 PHI 22-9921 275
 PHI 23-2626 276
 PHI 23-2628 276
 PHI 23-4625 276
 PHI 24-4621 274
 PHI 24-4721 274
 PHI 24-4951 274
 PHI 3-192 301
 PHI 3-194 301
 PHI 3-222 300
 PHI 3-224 300
 PHI 3-242 300
 PHI 3-243 300
 PHI 3-244 300
 PHI 3-327 299
 PHI 3-328 299
 PHI 3-329 299
 PHI 3-511 301
 PHI 3-511-250 301
 PHI 3-512 301
 PHI 3-512-250 301
 PHI 3-602 300
 PHI 3-603 300
 PHI 3-613 299
 PHI 3-622 299
 PHI 3-623 299
 PHI 3-624 299
 PHI 3-632 299
 PHI 3-633 299
 PHI 3-653 300
 PHI 3-654 300
 PHI 3-663 300
 PHI 30-2050 275
 PHI 30-2051 275
 PHI 30-2070 275
 PHI 30-2071 275
 PHI 30-4621 274
 PHI 30-4921 274
 PHI 30-4951 274
 PHI 30-9620 274
 PHI 30-9920 274
 PHI 30-9924 274
 PHI 31-9623 275
 PHI 31-9923 275
 PHI 4-121 282

T

TFW 41111HD 310
 TFW 42111HD 310
 TFW 42114HD 310

TFW 42146HD 310
 TFW 42318HD 310
 TFW 42352HD 310
 TFW 43021HD 310
 TFW 43042HD 310
 TFW 43125HD 310
 TFW 43233HD 310
 TFW 43240HD 310
 TFW 43307HD 310
 TFW 43309HD 310
 TFW 43320HD 310
 TFW 43321HD 310
 TFW 43325HD 310
 TFW 43545HD 310
 TFW 43554HD 310
 TFW 44052HD 310
 TFW 44053HD 310
 TFW 44054HD 310
 TFW 44058HD 310
 TFW 44059HD 310
 TFW 44064HD 310
 TFW 44066HD 310
 TFW 44084HD 310
 TFW 44086HD 310
 TFW 44092HD 310
 TFW 44094HD 310
 TFW 44600HDBP 310
 TFW 45009HD 310
 TFW 45051HD 310
 TFW 45054HD 310
 TFW 46001HD 310
 TFW 46002HD 310
 TFW 46003HD 310
 TFW 46004HD 310
 THM 138 313
 THM 169 313
 THM 613-060 313
 THM 613-070 313
 THM 613-080 313
 THM 613-090 313
 TWD 046U80-6N 52
 TWD 046U83-6N 52
 TWD 046U90-6N 52
 TWD 046U93-6N 52
 TWD 046U95-6N 52
 TWD 051U83-6N 51
 TWD 051U93-6N 51
 TWD 051U95-6N 51
 TWD 059U83-6N 50
 TWD 059U93-6N 50
 TWD 077U80-6N 49
 TWD 077U83-6N 49
 TWD 077U83-6N 49
 TWD 077U93-6N 49
 TWD 077U95-6N 49
 TWD 08595-01 160
 TWD 09729-01 160
 TWD 09730-01 158
 TWD 09832-01 160
 TWD 1-0153 206
 TWD 100124 118
 TWD 100132 118
 TWD 100386H 216
 TWD 10051-01 160
 TWD 101900X 102
 TWD 102657N 102
 TWD 102705729 211
 TWD 10459008 303
 TWD 10459013 303
 TWD 10459037 303
 TWD 10459076 303
 TWD 10459320 303
 TWD 10461052 309
 TWD 10461053 309
 TWD 10461055 309
 TWD 10461075 309
 TWD 10461098 309
 TWD 10461169 309
 TWD 110444 305
 TWD 110555JHO 305
 TWD 110555PHO 305

TWD 13805-01 158
 TWD 13805-01R 158
 TWD 1443E23 48
 TWD 14682-01 159
 TWD 14682-01R 159
 TWD 14689-01 158
 TWD 14696-01 158
 TWD 15-134X 208
 TWD 15-153X 208
 TWD 15-155X 208
 TWD 15-160X 208
 TWD 15-170X 208
 TWD 15-178X 208
 TWD 15-188X 208
 TWD 15-213X 208
 TWD 15-3147X 208
 TWD 15-5111X 208
 TWD 15-6111X 208
 TWD 15-677X 208
 TWD 15-7111X 208
 TWD 15-8111X 208
 TWD 15-85111X 208
 TWD 15-9111X 208
 TWD 15172-01 160
 TWD 15737-01R 159
 TWD 16571B 58
 TWD 1702817 210
 TWD 1702827 210
 TWD 17600B 116
 TWD 19020310 303
 TWD 19020889 303
 TWD 210084-2X 209
 TWD 210084-2XV 209
 TWD 210088-1X 209
 TWD 210088-1XV 209
 TWD 210121-1X 209
 TWD 210207-1XV 209
 TWD 210391-1XV 209
 TWD 210433-1XV 209
 TWD 210866-1X 209
 TWD 210866-1XV 209
 TWD 210875-1XV 209
 TWD 2339130-550 222
 TWD 2339131-550 222
 TWD 23421-01 159
 TWD 2343070-550 222
 TWD 2343071-550 222
 TWD 2345038-900 222
 TWD 2345039-900 222
 TWD 2356001-552 223
 TWD 240088X 292
 TWD 240378X 292
 TWD 240478X 292
 TWD 240598X 292
 TWD 240638X 291
 TWD 240828X 292
 TWD 241068X 292
 TWD 242138X 292
 TWD 242148X 291
 TWD 244508X 292
 TWD 245058X 288
 TWD 2484-068X 287
 TWD 2484-168X 287
 TWD 2484-ABX 287
 TWD 2484BX 287
 TWD 2502817 210
 TWD 27404PKWHT21 70
 TWD 2800LC 305
 TWD 286718 102
 TWD 287053N 102
 TWD 28828PKWHT21 71
 TWD 29039PKWHT21 71
 TWD 29195PKWHT21 71
 TWD 29300PKWHT21 71
 TWD 3004009 79
 TWD 30055-108X 283
 TWD 30055-158X 283
 TWD 30055-208X 283
 TWD 30055-258X 283
 TWD 30055-308X 283
 TWD 30055-408X 283



PART NUMBERS INDEX

TWD 30055-50BX	283	TWD 431101	312	TWD 5-279X	207	TWD 6222035-001	223
TWD 30055-6BX	283	TWD 431102	312	TWD 5-280X	207	TWD 6222051-001	223
TWD 30055-8BX	283	TWD 431103	312	TWD 5-281X	207	TWD 6222079-001	223
TWD 30056-10BX	283	TWD 431104	312	TWD 5-308X	207	TWD 6222082-001	223
TWD 30056-15BX	283	TWD 431107	312	TWD 5-3147X	207	TWD 628347	210
TWD 30056-20BX	283	TWD 431116	312	TWD 5-324X	207	TWD 628467	210
TWD 30056-25BX	283	TWD 431117	312	TWD 5-326X	207	TWD 632651KX	210
TWD 30056-30BX	283	TWD 4311E23	48	TWD 5-407X	207	TWD 632671KX	210
TWD 30056-40BX	283	TWD 4363851	217	TWD 5-674X	207	TWD 632817	210
TWD 30056-50BX	283	TWD 4378215	218	TWD 5-675X	207	TWD 63321KX	210
TWD 3022BX	53	TWD 437951030	214	TWD 5-676X	207	TWD 63341KX	210
TWD 3032BX	284	TWD 437951130	214	TWD 5-677X	207	TWD 633441KX	210
TWD 3034009	79	TWD 437951530	214	TWD 5-785X	207	TWD 640521	211
TWD 30409-10BX	283	TWD 4398610	216	TWD 5-790X	207	TWD 640541	211
TWD 30409-15BX	283	TWD 441004	119	TWD 5-795X	207	TWD 6461-A	82
TWD 30409-20BX	283	TWD 441014	119	TWD 5-799X	207	TWD 646371	210
TWD 30409-25BX	283	TWD 441019	119	TWD 5-801X	207	TWD 646871X	210
TWD 30409-30BX	283	TWD 441023	119	TWD 50180PKWHT21	70	TWD 6471411	210
TWD 3070723	81	TWD 441171	119	TWD 50408PKGRY21	71	TWD 647181X	210
TWD 3070743	81	TWD 441172	119	TWD 50408PKWHT21	71	TWD 6477711X	210
TWD 3090973	81	TWD 441751	123	TWD 50409PKWHT21	71	TWD 647771X	210
TWD 320121	118	TWD 4474723	85	TWD 50487PKWHT21	71	TWD 6500532	85
TWD 320122	118	TWD 4474743	85	TWD 55014BX	289	TWD 6500537	85
TWD 320131	118	TWD 4494973	85	TWD 55021-07BX	289	TWD 6500539	85
TWD 3303009	79	TWD 451028	127	TWD 55021BX	289	TWD 6528117	210
TWD 3404009	79	TWD 451030	128	TWD 55046BX	290	TWD 6528127	210
TWD 3434009	79	TWD 451031	128	TWD 55054BX	290	TWD 6531351KX	210
TWD 3434024	79	TWD 451031B	128	TWD 552-A	82	TWD 6531371KX	210
TWD 3434195	79	TWD 451031G	128	TWD 555-S	82	TWD 6531451KX	210
TWD 3434249	79	TWD 451031R	128	TWD 5582-10BX	289	TWD 653311	211
TWD 3595990	79	TWD 451032	128	TWD 5582BX	289	TWD 6540201	211
TWD 3600A	59	TWD 451032R	128	TWD 5584BX	289	TWD 6542531X	210
TWD 3600AX	59	TWD 451033	128	TWD 5586BX	289	TWD 6542711X	210
TWD 3687X	59	TWD 451034	128	TWD 5592BX	290	TWD 6543381X	210
TWD 3710X	59	TWD 451044	127	TWD 56864B	55, 57	TWD 6543561X	210
TWD 3721AX	59	TWD 451063	127	TWD 58328-04BX	291	TWD 6543731X	210
TWD 3727097	81	TWD 451097	128	TWD 58328-11BX	291	TWD 65445711X	210
TWD 3727098	81	TWD 451098	128	TWD 5901	74	TWD 6544631	210
TWD 3727099	81	TWD 451099	128	TWD 5902	74	TWD 655391	211
TWD 3753X	59	TWD 451106	128	TWD 5903	74	TWD 66864B	57
TWD 3757	59	TWD 4515E20	51	TWD 592-A	82	TWD 68213412	211
TWD 3757X	59	TWD 4515E23	51	TWD 594-A	82	TWD 7303997	218
TWD 3758X	59	TWD 4515EA23	51	TWD 598-A	82	TWD 7381	74
TWD 3782X	59	TWD 4588010	215	TWD 60000-018	53	TWD 75903BX	288
TWD 3800X	59	TWD 4588011	215	TWD 600004HD	54	TWD 75904-01BX	288
TWD 3807A	59	TWD 4594310	216	TWD 600013HD	54	TWD 75907BX	288
TWD 3807AX	59	TWD 4594320	216	TWD 600014HD	54	TWD 75908BX	287
TWD 3828036	81	TWD 4598234	215	TWD 60501-000	138	TWD 75920BX	287
TWD 3828064	81	TWD 4598242	215	TWD 60876B	57	TWD 7902	74
TWD 3830136	81	TWD 4598243	215	TWD 60876F	57	TWD 81255BX	290
TWD 3830164	81	TWD 46377-6BX	283	TWD 61510B	57	TWD 81264BX	290
TWD 3922X	59	TWD 46377-8BX	283	TWD 61511F	57	TWD 8172005	219
TWD 3929099	81	TWD 4702E23	50	TWD 61526F	57	TWD 8172010	219
TWD 3929112	81	TWD 4702EA20	50	TWD 61527B	57	TWD 8200289	309
TWD 3929131	81	TWD 4707E20	52	TWD 61528B	57	TWD 8215203	220
TWD 3930173	81	TWD 4707EA20	52	TWD 61529B	57	TWD 8215239	220
TWD 401145	117	TWD 4707EA23	52	TWD 61529F	57	TWD 8217048	220
TWD 401146	117	TWD 4707ESD23	52	TWD 61536F	57	TWD 8231275	218
TWD 401148	116	TWD 4709E20	49	TWD 61548F	57	TWD 8231280	219
TWD 401152	116	TWD 4709E23	49	TWD 61554F	57	TWD 8231281	219
TWD 401153	116	TWD 4709EA23	49	TWD 61566F	57	TWD 8231282	219
TWD 401155	116	TWD 4797011	215	TWD 61567B	57	TWD 8232018	219
TWD 401156	116	TWD 4797111	215	TWD 61567F	57	TWD 8235075	218
TWD 401157	117	TWD 4811721120	217	TWD 61571F	57	TWD 8235076	218
TWD 401160	117	TWD 4840710	218	TWD 61574F	57	TWD 8235092	219
TWD 4038611	218	TWD 4867213	217	TWD 61576B	57	TWD 8600066	303
TWD 4060217	217	TWD 4867215	217	TWD 61576F	57	TWD 8600314	303
TWD 4060218	217	TWD 4898725	214	TWD 61577B	57	TWD 8600889	303
TWD 4099BX	293	TWD 4903951	217	TWD 61577F	57	TWD 8700008	303
TWD 41362SP	70	TWD 4920526	217	TWD 61586F	57	TWD 8700018	303
TWD 416601030	214	TWD 4936810	215	TWD 61591F	57	TWD 87101B	54
TWD 416601430	214	TWD 4937710	216	TWD 61595F	57	TWD 88797B	54
TWD 4231310	214	TWD 4958410	216	TWD 61599F	57	TWD 89996B	54
TWD 4231317	214	TWD 5-103X	207	TWD 61600B	57	TWD 90030BX	291
TWD 43-X-1194	65	TWD 5-153X	207	TWD 61601F	57	TWD 9245BX	291
TWD 431093	312	TWD 5-155X	207	TWD 61606F	57	TWD 95534724	211
TWD 431094	312	TWD 5-160X	207	TWD 61612F	57	TWD 998-0046-00	161
TWD 431095	312	TWD 5-170X	207	TWD 61725F	57	TWD AC001	137
TWD 431096	312	TWD 5-178X	207	TWD 61727F	57	TWD AC001D	137
TWD 431098	312	TWD 5-188X	207	TWD 61729F	57	TWD AC002D	138
TWD 431099	312	TWD 5-213X	207	TWD 61730F	57	TWD AC003	142

TWD AC004	142	TWD AGA9082	170	TWD BEN5008414PG	104	TWD CAM155L	29
TWD AC005NC	141	TWD AGA9122	170	TWD BEN5008574	105	TWD CAM155R	29
TWD AC007	148	TWD AGA9265	170	TWD BEN5009107N	105	TWD CAM156L	29
TWD AC008	148	TWD AGA9270	170	TWD BEN800243	102-105	TWD CAM156R	29
TWD AC009	150	TWD AGA9373	170	TWD BEN800350	109	TWD CAM158L	30
TWD AC009K	150	TWD AGA9422	170	TWD BEN800383	105	TWD CAM158R	30
TWD AC010	149	TWD AGA9541	170	TWD BEN800405	103	TWD CAM159L	30
TWD AC014CR	152	TWD AGA9580	170	TWD BEN800576	105	TWD CAM159R	30
TWD AC014HR	152	TWD AGA9622	170	TWD BEN800887	104	TWD CAM174L	34
TWD AC014SR	152	TWD AGA9648	170	TWD BEN800972	104	TWD CAM174R	34
TWD AC015CAP	143	TWD AGA9780	170	TWD BEN801116	109	TWD CAM175LQ	28
TWD AC015K	143	TWD AGA9781	170	TWD BEN801330	105	TWD CAM175RQ	28
TWD AC015MG	143	TWD AGA9807	170	TWD BENK021557	109	TWD CAM198L	29
TWD AC019	141	TWD ALTO050	307	TWD BENK021558	109	TWD CAM198R	29
TWD AC026	141	TWD ALTO060	307	TWD BENK021562	109	TWD CAM199L	29
TWD AC027	141	TWD ALTO061	307	TWD BENOR229635X	111	TWD CAM199R	29
TWD AC028	148	TWD ALTO270	307	TWD BENOR279000X	110	TWD CAM200L	32
TWD AC033	143	TWD ALT1003	305-306	TWD BENOR288605X	110	TWD CAM200R	32
TWD AC033K	143	TWD ALT1004	305-306	TWD BETA25RL	220	TWD CAM201L	32
TWD AC038R	145	TWD ALT1240	305-306	TWD BETB23	221	TWD CAM201R	32
TWD AC043R	145	TWD ALT1280	306	TWD BETB25	221	TWD CAM203L	32
TWD AC044R	145	TWD ALT1281	306	TWD BETB35	221	TWD CAM203R	32
TWD AC045	144	TWD ALT1282	306	TWD BETB82	221	TWD CAM205L	32
TWD AC047R	149	TWD ALT3600	306	TWD BETRT25	221	TWD CAM205R	32
TWD AC048R	146	TWD ALT3632	306	TWD BF1259	196	TWD CAM206L	32
TWD AC049	149	TWD ALT3650	306	TWD BF5800	196	TWD CAM206R	32
TWD AC056	151	TWD AS1132	19	TWD BF7587	196	TWD CAM209L	32
TWD AC056K	151	TWD AS1133	19	TWD BF7766	196	TWD CAM209R	32
TWD AC060	146	TWD AS1136	19	TWD BF7814	196	TWD CAM210L	31
TWD AC061	147	TWD AS1138	19	TWD BF988	196	TWD CAM210R	31
TWD AC063	152	TWD AS1140	19	TWD BHK003	48	TWD CAM215L	29
TWD AC064	147	TWD AS1141	19	TWD BHK009	48	TWD CAM215R	29
TWD AC072	155	TWD AS1150	19	TWD BHK051	51-52	TWD CAM220L	33
TWD AC074	142	TWD AS4004	19	TWD BHK059	50	TWD CAM220R	33
TWD AC075	142	TWD AVI555P	305	TWD BHK077	49	TWD CAM226L	32
TWD AC078	150	TWD B1400	196	TWD BP100	233	TWD CAM226R	32
TWD AC083	155	TWD B495	196	TWD BP300	233	TWD CAM227L	32
TWD AC084	155	TWD B673025WTBK	221	TWD BP304	233	TWD CAM227R	32
TWD AC085	146	TWD B7685	196	TWD BP400	233	TWD CAM228L	29
TWD AC087	147	TWD B99	196	TWD BP650-A	230	TWD CAM228R	29
TWD AC088	146	TWD BAV050SA	202	TWD BP670-1	230	TWD CAM250L	31
TWD AC090	144	TWD BC7242	196	TWD BR3782	82	TWD CAM250R	31
TWD AC091	144	TWD BD103	196	TWD BR572	82	TWD CAM251L	31
TWD AC091S	144	TWD BD7153	196	TWD BR580	82	TWD CAM251R	31
TWD AC092	147	TWD BEN065228	102	TWD BR6420	82	TWD CAM256L	27
TWD AC095	150	TWD BEN065612	105	TWD BR653	82	TWD CAM256R	27
TWD AC095TD	150	TWD BEN065624	104	TWD BR663	82	TWD CAM290L	27
TWD AC100D	154	TWD BEN065624PG	104	TWD BRE52S	203	TWD CAM290R	27
TWD AC100SS	153	TWD BEN065647	102	TWD BRE62S	203	TWD CAM303L	30
TWD AC101	140	TWD BEN065706	110	TWD BRE72S	203	TWD CAM303R	30
TWD AC103	140	TWD BEN107695	103	TWD BT595	196	TWD CAM316L	32
TWD AC105	151	TWD BEN107794X	103	TWD BW5071	196	TWD CAM316R	32
TWD AC106	151	TWD BEN107796	103	TWD BW5136	196	TWD CAM319L	31
TWD AC194	143	TWD BEN107796PG	103	TWD C105017	197	TWD CAM319R	31
TWD AC195	144	TWD BEN107799	103	TWD CA4700	196	TWD CAM3343L	27
TWD AC196	143	TWD BEN107800N	103	TWD CA4999	196	TWD CAM3343R	27
TWD AC197	122	TWD BEN109493X	104	TWD CA5352	196	TWD CAM345L	29
TWD AC198	122	TWD BEN109494	104	TWD CAM101L	27	TWD CAM345R	29
TWD AC199	150	TWD BEN109495	104	TWD CAM101R	27	TWD CAM348L	28
TWD AC200	153	TWD BEN109496	104	TWD CAM114LQ	28	TWD CAM348R	28
TWD AC200D	154	TWD BEN109498	104	TWD CAM114RQ	28	TWD CAM349L	29
TWD AC200L	155	TWD BEN109578	103	TWD CAM119LQ	28	TWD CAM349R	29
TWD AC200SS	153	TWD BEN109579	103	TWD CAM119RQ	28	TWD CAM354L	32
TWD AC201	137	TWD BEN109871N	103-104	TWD CAM123L	31	TWD CAM354R	32
TWD AC202	138	TWD BEN109995	104	TWD CAM123R	31	TWD CAM362L	32
TWD AC211SS	153	TWD BEN131031	104	TWD CAM124L	31	TWD CAM362R	32
TWD AC240	154	TWD BEN131081	109	TWD CAM124R	31	TWD CAM379L	31
TWD AC245	154	TWD BEN229635N	111	TWD CAM138L	33	TWD CAM379R	31
TWD AC345	154	TWD BEN279000N	110	TWD CAM138R	33	TWD CAM388L	30
TWD AGA1191	170	TWD BEN280905N	111	TWD CAM140L	33	TWD CAM388R	30
TWD AGA8050	170	TWD BEN284142N	109	TWD CAM140R	33	TWD CAM389L	34
TWD AGA8091	170	TWD BEN286934N	102	TWD CAM141L	30	TWD CAM389R	34
TWD AGA8204	170	TWD BEN5001247	104	TWD CAM141R	30	TWD CAM395L	30
TWD AGA8708	170	TWD BEN5003838	103	TWD CAM143L	34	TWD CAM395R	30
TWD AGA8709	170	TWD BEN5004338	103	TWD CAM143R	34	TWD CAM400L	34
TWD AGA8713	170	TWD BEN5004339	103	TWD CAM146L	31	TWD CAM400R	34
TWD AGA8729	170	TWD BEN5004341X	103	TWD CAM146R	31	TWD CB2106611XSA	206
TWD AGA8755	170	TWD BEN5005037	103	TWD CAM153L	34	TWD CS2000	38, 40-41, 44
TWD AGA8829	170	TWD BEN5005624	104	TWD CAM153R	34	TWD CS2001	44
TWD AGA8852	170	TWD BEN5005893	103	TWD CAM154L	29	TWD CS2002	44
TWD AGA9069	170	TWD BEN5008414	104	TWD CAM154R	29	TWD CS2003	38, 41, 44

PART NUMBERS INDEX

TWD CS2014L	43-44	TWD CSK1060	40	TWD FXI2	230	TWD H002436	197
TWD CS2014R	43-44	TWD CSK1062	40	TWD G112404	197	TWD H00450CE	132
TWD CS2020	44	TWD CSK1064	41	TWD G1201X	59	TWD H00550B	227
TWD CS3000	35, 40, 42	TWD CSK1068	41	TWD G1213X	59	TWD H00550C	227
TWD CS3001	36-37, 42	TWD CSK1072	41	TWD G150048	197	TWD H00570CF	227
TWD CS3002	36, 39	TWD CSK1074	42	TWD G1813	167	TWD H00600P	132
TWD CS3004	37	TWD CSK1076	42	TWD G1815	167	TWD H00640R	226
TWD CS3006	38, 41	TWD CSK1080	43	TWD GFADC012341X	10	TWD H00900CA	226
TWD CS3009	36	TWD CSK1081	43	TWD GFADC012342X	10	TWD H00977	226
TWD CS3020	37	TWD CSK4100	46	TWD GFADC109957X	10	TWD H00978	226
TWD CS3021	35, 40, 42-43	TWD CSK4101	45	TWD GFADC109958X	10	TWD H00984B	226
TWD CS3022	38	TWD CSK4102	45	TWD GFADC109961X	10	TWD H01500UN	132
TWD CS3023	41	TWD CSK4104	45	TWD GFADC109962X	10	TWD H01501PUD	132
TWD CS3028	40	TWD CSK4105	46	TWD GFADC113887X	10	TWD H01501UD	132
TWD CS3040	40	TWD CSK4106	46	TWD GFADC113888X	10	TWD H065066	102
TWD CS3041	35, 40, 42	TWD CSK4112	45	TWD GFADCW25015	10	TWD H065225	102
TWD CS3042	41	TWD CSK4113	45	TWD GFADCW25016	10	TWD H11477S	227
TWD CS3043	37	TWD CSK4115-1	46	TWD GFADCW50800	10	TWD H12012	122
TWD CS3046	38	TWD CSK4115-2	46	TWD GFADCW50810	10	TWD H13723S	227
TWD CS3062	36, 40	TWD CSK4119	45	TWD GFADCW75072	10	TWD H13940S	227
TWD CS3064	36	TWD CSK4120	45	TWD GFADCW75073	10	TWD H389K	60
TWD CS3065	36-37, 40	TWD CSK4129	45	TWD GFADCW95037	10	TWD H401046	115
TWD CS3066	35, 40, 42	TWD CSK4130	45	TWD GFADCW95038	10	TWD H401047	115
TWD CS3067	38	TWD CSK4139	45	TWD GFC13706-7	4, 7	TWD H41004	121
TWD CS3068	41	TWD CSK4141	45	TWD GFC14684012-3	4, 7	TWD H41014	121
TWD CS3069	38, 41, 43	TWD CSK4150AM	45	TWD GFC147076	4, 7	TWD H41736	122
TWD CS3071	36, 39, 42	TWD CSK4157	45	TWD GFC147077	4, 7	TWD H41737	122
TWD CS3072	36, 39	TWD CSK4166	45	TWD GFC55250	4, 7	TWD H41737-S	122
TWD CS3101	39	TWD CSK4167	46	TWD GFC55251	4, 7	TWD H41738	122
TWD CS3102	36, 38-41	TWD CSK4178	45	TWD GFC55252	4, 7	TWD H41738-BRS	122
TWD CS3103	38, 40-41	TWD CSK4185	45	TWD GFC55314	4, 7	TWD H41738-S	122
TWD CS3104	36-37, 39	TWD CSK4208	45	TWD GFC55849	4, 7	TWD H41751	123
TWD CS3105	36-37	TWD CSK4213	45	TWD GFC55850	4, 7	TWD H51001	129
TWD CS3106	41	TWD CV102	230	TWD GFP1066-CE	5	TWD H51009	129
TWD CS3107	35, 39, 42	TWD D0010140	12	TWD GFP1203-KV	8	TWD H51037	129
TWD CS3108	35, 40	TWD D0010143	12	TWD GFP1203-SD	8	TWD H51038	129
TWD CS3109	35-43	TWD D0010144	12	TWD GFP1310-KV	8	TWD H801041	12
TWD CS3110	36	TWD D0010211	12	TWD GFP1311-KV	8	TWD H801042	12
TWD CS3111	36	TWD D0010212	12	TWD GFP1311-SD	8	TWD H801073	12
TWD CS3113	36	TWD D0010215	12	TWD GFP1312-KV	8	TWD H801074	12
TWD CS3114	38	TWD D0010216	12	TWD GFP1369-KV	8	TWD H950011	101
TWD CS3115	37-38	TWD D0010306	12	TWD GFP1369-SD	8	TWD H950013	101
TWD CS3116	41	TWD D071	159	TWD GFP1407-KV	8	TWD H950014	101
TWD CS3116	40, 42-43	TWD D214	157	TWD GFP1438-KV	8	TWD H950015	101
TWD CS3119	39-40, 42	TWD D6052	61	TWD GFP1438-SD	8	TWD H950017	101
TWD CS3121	35, 43	TWD D6054	61	TWD GFP1518-KV	8	TWD H955205	101
TWD CS3123	36	TWD D6054C	61	TWD GFP1518-SD	8	TWD HA72420	101
TWD CS3124	36	TWD D6059	61	TWD GFP1777-KV	8	TWD HAS1132	12
TWD CS3125	38, 41	TWD D607	230	TWD GFP1777-SD	8	TWD HAS1133	12
TWD CS3127	41	TWD D6176M	61	TWD GFP184-CE	5	TWD HAS1136	12
TWD CS3129	41	TWD D6178M	61	TWD GFP2061-KV	8	TWD HAS1140	12
TWD CS3130	39	TWD D6183M	61	TWD GFP224-CE	5	TWD HAS1141	12
TWD CS3132	38	TWD D704	230	TWD GFP225-CE	5	TWD HAS1147	12
TWD CS3140	36, 38-43	TWD D709	230	TWD GFP236-CE	5	TWD HAS3000	13
TWD CS3142	36, 38-41	TWD D710	230	TWD GFP769-CE	5	TWD HAS3016	13
TWD CS3144	39-40	TWD D711	230	TWD GFP786-CETK	5	TWD HAS3018	13
TWD CS3145	35, 37-40, 42-43	TWD D740	230	TWD GFP786A-CETN	5	TWD HAS3019	13
TWD CS3146	37-38, 41	TWD DBL3998	197	TWD GFR141394G	6	TWD HAS4004	13
TWD CS3148	38, 41	TWD DBL7900	197	TWD GFR19996G	6	TWD HD12-136	121
TWD CS3149	36, 37	TWD DX19539	62	TWD GFR20109G	9	TWD HD12-138	121
TWD CS3300	44	TWD DX19540	62	TWD GFR54102G	6	TWD HD12-306	121
TWD CS3301	44	TWD DX225211001K	65	TWD GFR54104G	6	TWD HD12-308	121
TWD CS3302	44	TWD DX225211002K	65	TWD GFR54105G	6	TWD HD12-600	123
TWD CS3303	44	TWD FR-UCF2467-001	156	TWD GFR54301G	6	TWD HD120100	121
TWD CS3311	37	TWD FR-UCF2470-001	156	TWD GFR54365G	6	TWD HD12S	100
TWD CS5000	46	TWD FR-UXA0015-001	156	TWD GFR54769G	6	TWD HD16S	100
TWD CSK1004	35	TWD FR-UXA0017	156	TWD GFR54770G	6	TWD HD2-2-329	204
TWD CSK1005	35	TWD FR-UXA0026-001	156	TWD GFR54771G	6	TWD HD2-2-479	204
TWD CSK1010	36	TWD FR-UXA0034	156	TWD GFR54773G	6	TWD HD2-4-503	204
TWD CSK1022	36	TWD FS300C	231	TWD GFR54775G	6	TWD HD2-4-533	204
TWD CSK1024	37	TWD FS400A	232	TWD GFR56641G	9	TWD HD20S	100
TWD CSK1026	37	TWD FS400C	231	TWD GFR56642G	9	TWD HD20S-LS	100
TWD CSK1028	37	TWD FW200A	232	TWD GFR6178AMG	6	TWD HD210140-1X	204
TWD CSK1035	38	TWD FW200C	231	TWD GFR71601G	9	TWD HD210207-1X	204
TWD CSK1038	38	TWD FW300A	232	TWD GFR75180G	9	TWD HD210370-1X	204
TWD CSK1040	38	TWD FW300C	231	TWD GFR76606G	9	TWD HD210391-1X	204
TWD CSK1046	39	TWD FW300CR	232	TWD GFR76613G	9	TWD HD210433-1X	204
TWD CSK1048	39	TWD FW400A	232	TWD GFR76617G	9	TWD HD210661-1X	204
TWD CSK1052	39	TWD FW400C	231	TWD GFR76618G	9	TWD HD210866-1X	204
TWD CSK1056	40	TWD FX196KX	60	TWD GFR76692G	9	TWD HD21106S	14
TWD CSK1058	36	TWD FXI1	230	TWD H001251	197	TWD HD22100S	14

TWD HD22153S	14	TWD HKN28080	115	TWD MSA111A	11	TWD P552100	196
TWD HD2424C	100	TWD HKN28510	115	TWD MSA112A	11	TWD P552200	196
TWD HD2430C	100	TWD HKN28520	115	TWD MSA113A	11	TWD P552231	196
TWD HD2430C-LS	100	TWD HKN28600	115	TWD MSA500	11	TWD P553000	196
TWD HD24S	100	TWD HM212011	82	TWD NP026773	83	TWD P553004	196
TWD HD24S-LS	100	TWD HM212049	82	TWD NP034946	83	TWD P554005	196
TWD HD3030	100	TWD HM218210	82	TWD NP053874	83	TWD P554071	196
TWD HD3030-KIT	100	TWD HM218248	82	TWD NP363298	83	TWD P556915	196
TWD HD3030C	100	TWD HM518410	82	TWD NP435398	83	TWD P558616	197
TWD HD3030C-LS	100	TWD HM518445	82	TWD NP874005	83	TWD P559000	196
TWD HD3030LS-KIT	100	TWD HR935K	60	TWD NP899357	83	TWD P564669	198
TWD HD3030SB	100	TWD HRB2155	229	TWD P007191	198	TWD P603577	196
TWD HD3030VC	100	TWD HRB2156	229	TWD P107844	198	TWD P606720	196
TWD HD3036C	100	TWD HRB2157	229	TWD P142100	196	TWD P607955	196
TWD HD30S	100	TWD HRB2158	229	TWD P153551	196	TWD P610875	196
TWD HD30S-LR	100	TWD HRB2159	229	TWD P181015	197	TWD P616400	196
TWD HD30S-LS	100	TWD HRB2173	229	TWD P206282	188	TWD P7230	196
TWD HD3636C	100	TWD HT224	102	TWD P206283	188	TWD P822686	196
TWD HD36S	100	TWD HT794RD	60	TWD P206334	187	TWD PA2631	196
TWD HD41106S	14	TWD J000216	184	TWD P206335	187	TWD PA2705	196
TWD HD5-1203X	204	TWD J000217	184	TWD P206336	187	TWD PA4701	196
TWD HD5-129X	204	TWD J000220	185	TWD P206337	187	TWD PF7680	196
TWD HD5-1306X	204	TWD J000221	185	TWD P206340	187	TWD PF7748	196
TWD HD5-134X	204	TWD J000227	185	TWD P206342	187	TWD PL-19-AC	293
TWD HD5-153X	204	TWD J000230	185	TWD P206344	187	TWD PL-19-GC	293
TWD HD5-155X	204	TWD J000232	185	TWD P206346	187	TWD PL-19-RC	293
TWD HD5-160X	204	TWD J008681	187	TWD P206347	187	TWD PL-2-AC	293
TWD HD5-170X	204	TWD J009604	184	TWD P206374	186	TWD PL-2-GC	293
TWD HD5-178X	204	TWD J009605	184	TWD P206375	186	TWD PL-2-RC	293
TWD HD5-188X	204	TWD J009606	184	TWD P206387	189	TWD PL-20-AC	293
TWD HD5-213X	204	TWD J009607	184	TWD P206400	187	TWD PL-20-GC	293
TWD HD5-242X	204	TWD J009623	184	TWD P206409	185	TWD PL-20-RC	293
TWD HD5-243X	204	TWD J009624	184	TWD P206410	185	TWD R0010221	76
TWD HD5-279X	204	TWD J034744	186	TWD P206411	185	TWD R004951	77
TWD HD5-280X	204	TWD J190003	187	TWD P206600	185	TWD R004952	77
TWD HD5-281X	204	TWD J190025	188	TWD P206602	185	TWD R004953	77
TWD HD5-3022X	204	TWD K-234Z	65	TWD P206603	185	TWD R004966L	76
TWD HD5-308X	204	TWD K90D	202	TWD P206607	184	TWD R004966R	76
TWD HD5-3147X	204	TWD KIT11107	162	TWD P206611	185	TWD R004967L	76
TWD HD5-324X	204	TWD KIT11300	162	TWD P206615	188	TWD R004967R	76
TWD HD5-326X	204	TWD KIT195011	66	TWD P207297	189	TWD R004968L	76
TWD HD5-407X	205	TWD KIT195013	65	TWD P207331	187	TWD R004968R	76
TWD HD5-6102X	205	TWD KIT195020	63	TWD P207332	187	TWD R005571P	74
TWD HD5-6106X	205	TWD KIT195021	63	TWD P207339	187	TWD R005706	75
TWD HD5-674X	205	TWD KIT225020	67	TWD P207341	187	TWD R005728	75
TWD HD5-675X	205	TWD KIT225021	67	TWD P207353	188	TWD R005729	75
TWD HD5-676X	205	TWD M-284BX	287	TWD P207354	188	TWD R005740	77
TWD HD5-677X	205	TWD M090544	189	TWD P207364	187	TWD R005743	77
TWD HD5-7000X	205	TWD M090594	189	TWD P207365	187	TWD R005872	77
TWD HD5-7105X	205	TWD M100463	189	TWD P207366	187	TWD R005955	77
TWD HD5-7202X	205	TWD M120450	189	TWD P208375	189	TWD R005960	77
TWD HD5-8105X	205	TWD M280X	205	TWD P208395	189	TWD R005983L	75
TWD HD5-9001X	205	TWD M281X	205	TWD P226141	186	TWD R005983R	75
TWD HD52321-Q29	139	TWD M407X	205	TWD P226142	186	TWD R005997	75
TWD HD52341-Q206	139	TWD M675X	205	TWD P226143	186	TWD R005999	75
TWD HD52341-Q2205	139	TWD M676X	205	TWD P226145	186	TWD R006030	76
TWD HD6-28-347	205	TWD M677X	205	TWD P226146	186	TWD R006036	75
TWD HD6-40-521	205	TWD MC8056KTAS	18	TWD P226147	186	TWD R008980	75
TWD HD8480KTA	14	TWD MC8410KTAS	18	TWD P226148	186	TWD R008981	75
TWD HD9218	121	TWD MC8415KTAS	18	TWD P226155	186	TWD R008987	75
TWD HD9219	121	TWD MC8420KTAS	18	TWD P226157	186	TWD R009020	74
TWD HD9221	121	TWD MC8425KTAS	18	TWD P226158	186	TWD R801700	18
TWD HD9222	121	TWD MC8480KTAS	18	TWD P270539	189	TWD R801730	18
TWD HDS170X	205	TWD MCK1154	63	TWD P270541	189	TWD R801732	18
TWD HDS250X	205	TWD MCK1159	66	TWD P502067	196	TWD R801773	18
TWD HDS90X	205	TWD MCK1161	63, 66	TWD P525956	198	TWD R801774	18
TWD HDSET401	84	TWD MCK1171	63	TWD P527484	196	TWD R803048	20
TWD HDSET402	84	TWD MCK1173	67	TWD P527682	196	TWD R803049	20
TWD HDSET403	84	TWD MCK1189	64	TWD P532966	196	TWD R803054	20
TWD HDSET405	84	TWD MCK1192	64, 67	TWD P534816	196	TWD R803055	20
TWD HDSET406	84	TWD MCK1196	67	TWD P534925	196	TWD R803106	20
TWD HDSET413	84	TWD MCK1294	64, 66	TWD P539765	196	TWD R803110	20
TWD HDSET414	84	TWD MCK1375	65	TWD P550425	196	TWD R803112	20
TWD HDSET415	84	TWD MER614723	84	TWD P550428	196	TWD R803195	20
TWD HDSET423	84	TWD MER614743	84	TWD P550463	196	TWD R810018	20
TWD HDSET424	84	TWD MER614836	84	TWD P550467	196	TWD R810019	20
TWD HDW28408EL	71	TWD MER614973	84	TWD P550529	196	TWD R810021	20
TWD HDW28409EL	71	TWD MF101	231	TWD P550769	196	TWD R810025	20
TWD HF805K	60	TWD MMD1525AF	63	TWD P551000	196	TWD R950011	107
TWD HKN26000	115	TWD MSA105A	11	TWD P551311	196	TWD R950012	107
TWD HKN28060	115	TWD MSA106A	11	TWD P552071	196	TWD R950013	108

PART NUMBERS INDEX

TWD R950014.....	108	TWD SET429.....	83	TWD W01-358-7472.....	174	TWD WLTO-L.....	78
TWD R950015.....	107	TWD SET430.....	83	TWD W01-358-7818.....	175	TWD WLTO-M.....	78
TWD R950017.....	108	TWD SMC50A.....	203	TWD W01-358-8008.....	175	TWD WLTO-N.....	78
TWD R950048.....	107	TWD SMR15S.....	203	TWD W01-358-8050.....	175	TWD WLTO-O.....	78
TWD R950068.....	107	TWD SPL100-1X.....	209	TWD W01-358-8091.....	175	TWD WLTO-P.....	78
TWD R950069.....	107	TWD SPL140X.....	209	TWD W01-358-8204.....	175	TWD X002277.....	198
TWD R955047.....	108	TWD SPL250-3X.....	209	TWD W01-358-8709.....	176	TWD X002278.....	198
TWD R955079.....	106	TWD SPL36-1X.....	209	TWD W01-358-8755.....	176	TWD X004476.....	185
TWD R955082.....	106	TWD SPL55-3X.....	209	TWD W01-358-8864.....	181	TWD X004478.....	185
TWD R955205.....	106	TWD SPL70X.....	209	TWD W01-358-9039.....	176	TWD X004480.....	185
TWD R955206.....	106	TWD STRO120.....	307	TWD W01-358-9069.....	176	TWD X004482.....	185
TWD R955207.....	106	TWD STRO123.....	307	TWD W01-358-9082.....	177	TWD X004484.....	185
TWD R955300.....	106	TWD STR4200.....	308	TWD W01-358-9101.....	177	TWD X006202.....	185
TWD R955315.....	106	TWD STR4201.....	308	TWD W01-358-9105.....	177	TWD X006203.....	185
TWD R955321.....	93	TWD STR4202.....	308	TWD W01-358-9121.....	177	TWD X007805.....	184
TWD R955335.....	93	TWD STR4207.....	308	TWD W01-358-9122.....	178	TWD X007824.....	184
TWD R955336.....	93	TWD STR4208.....	308	TWD W01-358-9144.....	178	TWD X007831.....	189
TWD R955338.....	94	TWD STR4292.....	308	TWD W01-358-9158.....	178	TWD X60046.....	53
TWD R955341.....	93	TWD STR4295.....	308	TWD W01-358-9243.....	178	TWD X60076.....	53
TWD R955342.....	93	TWD STR4302.....	308	TWD W01-358-9265.....	179	TWD X60077.....	53
TWD R955344.....	93	TWD STR4303.....	308	TWD W01-358-9270.....	179	TWD X60114.....	53
TWD R955378.....	95	TWD STR7051.....	307	TWD W01-358-9287.....	179	TWD X60420.....	53
TWD RS2863.....	196	TWD T5427.....	158	TWD W01-358-9293.....	179	TWD X60434.....	53
TWD RS3517.....	196	TWD T5493.....	159	TWD W01-358-9295.....	179	TWD X60481.....	53
TWD RS3518.....	196	TWD T5493R.....	159	TWD W01-358-9321.....	180	TWD X60611.....	53, 57
TWD RS3534.....	196	TWD T5524R.....	158	TWD W01-358-9366.....	180	TWD X60613.....	53
TWD RS3539.....	196	TWD T5565.....	159	TWD W01-358-9371.....	180	TWD X60789.....	53
TWD RS3715.....	196	TWD T5566.....	159	TWD W01-358-9580.....	181	TWD X60794.....	53, 59
TWD RS3743.....	196	TWD TGL3410ST.....	202	TWD W01-358-9780.....	181	TWD X61223B.....	53, 57
TWD RS4642.....	196	TWD TGL34SBR.....	202	TWD W01-358-9921.....	180	TWD X61225B.....	53, 57
TWD RX226K.....	60	TWD TK16656.....	161	TWD W01-358-9974.....	181	TWD X61233.....	57
TWD S19802.....	96	TWD TK16657.....	161	TWD WB116GST.....	80	TWD X61363.....	57
TWD S19803.....	96	TWD TK18998.....	160, 162-167	TWD WB117HC.....	80		
TWD S19804.....	96	TWD TK7319.....	160, 163-167	TWD WCHT-A.....	78		
TWD S19805.....	96	TWD TRA-0013-00.....	156	TWD WCHT-B.....	78		
TWD S28080.....	96	TWD TRA-0015-00.....	156	TWD WCHT-F.....	78		
TWD S28090.....	96	TWD TRA-0017-00.....	156	TWD WJ195.....	228		
TWD S28130.....	96	TWD TRA-0697-00.....	156	TWD WJ201A.....	228		
TWD S28140.....	96	TWD TRA-2270-00.....	161	TWD WJ202.....	228		
TWD S29000.....	96	TWD TRA-2297-00.....	161	TWD WJ206.....	228		
TWD S29190.....	96	TWD TRA-2726-00.....	157	TWD WJ208.....	228		
TWD S29710.....	96	TWD TRA-2727-00.....	157	TWD WLCH-B.....	78		
TWD S30180.....	96	TWD TRA-2728-00.....	157	TWD WLCH-C.....	78		
TWD S30300.....	96	TWD TRA-2740-00.....	157	TWD WLCH-D.....	78		
TWD S30500.....	96	TWD TRA-2741-00.....	157	TWD WLCH-F.....	78		
TWD S4005001030.....	94	TWD TRA-3343-00.....	161	TWD WLCH-G.....	78		
TWD S4461082010.....	94	TWD TRA-3603-00.....	156	TWD WLCH-H.....	78		
TWD S4497130180.....	95	TWD TX228K.....	60	TWD WLCH-I.....	78		
TWD S4497130300.....	95	TWD TX229K.....	60	TWD WLCH-J.....	78		
TWD S4497130500.....	95	TWD TX230K.....	60	TWD WLCH-K.....	78		
TWD S4721950330.....	95	TWD TX745K.....	60	TWD WLCH-L.....	78		
TWD S50010.....	96	TWD TY233K.....	60	TWD WLCH-M.....	78		
TWD S71914.....	96	TWD US170X.....	206	TWD WLCH-N.....	78		
TWD S8946073120.....	95	TWD US250X.....	206	TWD WLCH-P.....	78		
TWD SET401.....	82-83	TWD VCGTX06.....	202	TWD WLTO-A.....	78		
TWD SET403.....	82-83	TWD VCGTX10.....	202	TWD WLTO-AA.....	78		
TWD SET405.....	82-83	TWD VCGTX15.....	202	TWD WLTO-B.....	78		
TWD SET406.....	82-83	TWD W01-358-6926.....	173	TWD WLTO-C.....	78		
TWD SET413.....	82-83	TWD W01-358-6935.....	173	TWD WLTO-D.....	78		
TWD SET414.....	82-83	TWD W01-358-7057.....	173	TWD WLTO-E.....	78		
TWD SET415.....	82-83	TWD W01-358-7135.....	173	TWD WLTO-F.....	78		
TWD SET423.....	82	TWD W01-358-7136.....	174	TWD WLTO-G.....	78		
TWD SET424.....	82	TWD W01-358-7403.....	174	TWD WLTO-H.....	78		
TWD SET427.....	83	TWD W01-358-7410.....	174	TWD WLTO-I.....	78		
TWD SET428.....	83	TWD W01-358-7424.....	174	TWD WLTO-J.....	78		
				TWD WLTO-K.....	78		

W

WIL 90014072.....	304
WIL 90014074.....	304
WIL 90014152.....	304
WIL 90014262.....	304
WIL 90014270.....	304
WIL 90014334.....	304
WIL 90014393.....	304
WIL 90015504.....	304
WIL 90025065.....	304
WIL 90047021.....	304
WIL 90059249.....	304
WIL 90059251.....	304
WIL 90156392.....	304
WIL 91013700.....	308
WIL 91013701.....	308
WIL 91013703.....	308
WIL 91013948.....	308
WIL 91014107.....	308
WIL 91014159.....	308
WIL 91014161.....	308
WIL 91014166.....	308
WIL 91014296.....	308
WIL 91014307.....	309
WIL 91014396.....	309
WIL 91157143.....	309
WIL 91295550.....	309
WWS 5061320.....	327
WWS RX68106.....	327
WWS RX68806.....	327



**HEAVY
DUTY**

TW Customer Service: **877-877-8764, 888-427-7820**

Hours of Operation: **7:30 a.m. – 6:00 p.m. EST**

Email: **twcustomerservice@genpt.com**

Email Subject Lines: **TW Pricing & Availability, TW Order Status**